

### STANDARD DIODES

### ADD-A-pak™ GEN V Power Modules

#### Features

- High Voltage
- Industrial Standard Package
- Thick copper baseplate
- UL E78996 approved
- 3500V<sub>RMS</sub> isolating voltage
- TOTALLY LEAD-FREE

#### Benefits

- Up to 1600V
- Full compatible TO-240AA
- High Surge capability
- Easy Mounting on heatsink
- Al<sub>2</sub>O<sub>3</sub> DBC insulator
- Heatsink grounded

60 A  
80 A

#### Mechanical Description

The Generation V of Add-A-pak module combine the excellent thermal performance obtained by the usage of Direct Bonded Copper substrate with superior mechanical ruggedness, thanks to the insertion of a solid Copper baseplate at the bottom side of the device. The Cu baseplate allow an easier mounting on the majority of heatsink with increased tolerance of surface roughness and improve thermal spread.

The Generation V of AAP module is manufactured without hard mold, eliminating in this way any possible direct stress on the leads.

The electrical terminals are secured against axial pull-out: they are fixed to the module housing via a click-stop feature already tested and proved as reliable on other IR modules.

#### Electrical Description

These modules are intended for general purpose high voltage applications such as high voltage regulated power supplies, lighting circuits, temperature and motor speed control circuits, UPS and battery charger.

#### Major Ratings and Characteristics

Parameters	IRK.56	IRK.71	Units
$I_{F(AV)}$ @ 100°C	60	80	A
$I_{F(RMS)}$	94	126	A
$I_{FSM}$ @ 50Hz	1600	1790	A
@ 60Hz	1680	1870	A
$i^2t$ @ 50Hz	12.89	15.90	KA <sup>2</sup> s
@ 60Hz	11.76	14.53	KA <sup>2</sup> s
$i^2\sqrt{t}$	128.9	159	KA <sup>2</sup> √s
$V_{RRM}$ range	400 to 1600		V
$T_J$	-40 to 150		°C
$T_{STG}$	-40 to 150		°C



## IRK.56, .71 Series

Bulletin I27210 03/06

International  
 Rectifier

### ELECTRICAL SPECIFICATIONS

#### Voltage Ratings

Type number	Voltage Code	$V_{RRM}$ , maximum repetitive peak reverse voltage V	$V_{RSM}$ , maximum non-repetitive peak rev. voltage V	$I_{RRM}$ max. @ 150°C mA
IRK.56/.71	04	400	500	10
	06	600	700	
	08	800	900	
	10	1000	1100	
	12	1200	1300	
	14	1400	1500	
	16	1600	1700	

#### Forward Conduction

Parameter	IRK.56	IRK.71	Units	Conditions
$I_{F(AV)}$ Max. average forward current @ Case temperature	60	80	A	180° conduction, half sine wave
	100	100	°C	
$I_{F(AV)}$ Max. average forward current @ Case temperature	55	70	A	180° conduction, half sine wave
	105	108	°C	
$I_{F(RMS)}$ Max. RMS forward current	94	126	A	DC @ 92°C case temperature
$I_{FSM}$ Max. peak, one-cycle forward, non-repetitive surge current	1600	1790	A	t = 10ms No voltage reappplied
	1680	1870		t = 8.3ms 100% $V_{RRM}$ reappplied
	1350	1500		t = 10ms reappplied
	1420	1570		t = 8.3ms reappplied
$I^2t$ Maximum $I^2t$ for fusing	12.89	15.90	KA <sup>2</sup> s	t = 10ms No voltage reappplied
	11.76	14.53		t = 8.3ms reappplied
	9.12	11.25		t = 10ms 100% $V_{RRM}$ reappplied
	8.32	10.23		t = 8.3ms reappplied
$I^2\sqrt{t}$ Maximum $I^2\sqrt{t}$ for fusing	128.9	159.0	KA <sup>2</sup> √s	t = 0.1 to 10ms, no voltage reappplied
$V_{F(TO)1}$ Low level value of threshold voltage	0.96	0.83	V	$(16.7\% \times \pi \times I_{F(AV)} < I < \pi \times I_{F(AV)})$ , $T_J = T_J \text{ max.}$
$V_{F(TO)2}$ High level value of threshold voltage	1.03	0.92		$(I > \pi \times I_{F(AV)})$ , $T_J = T_J \text{ max.}$
$r_{f1}$ Low level value of forward slope resistance	2.81	2.68	mΩ	$(16.7\% \times \pi \times I_{F(AV)} < I < \pi \times I_{F(AV)})$ , $T_J = T_J \text{ max.}$
$r_{f2}$ High level value of forward slope resistance	2.48	2.40		$(I > \pi \times I_{F(AV)})$ , $T_J = T_J \text{ max.}$
$V_{FM}$ Max. forward voltage drop	1.51	1.50	V	$I_{FM} = \pi \times I_{F(AV)}$ , $T_J = 25^\circ\text{C}$ , $t_p = 400\mu\text{s}$ square wave

#### Blocking

Parameter	IRK.56	IRK.71	Units	Conditions
$I_{RRM}$ Max. peak reverse leakage current	10		mA	$T_J = 150^\circ\text{C}$
$V_{INS}$ RMS isolation voltage	3500 (1 sec)		V	50 Hz, circuit to base, all terminals shorted

**Thermal and Mechanical Specifications**

Parameter	IRK.56	IRK.71	Units	Conditions
T <sub>J</sub> Junction temperature range	-40 to 150		°C	
T <sub>stg</sub> Storage temperature range	-40 to 150		°C	
R <sub>thJC</sub> Max. thermal resistance, junction to case	0.5	0.4	K/W	Per junction, DC operation
R <sub>thCS</sub> Typical thermal resistance, case to heatsink	0.1		K/W	Mounting surface flat, smooth and greased
T Mounting torque ±10% to heatsink busbar	5 4		Nm	A mounting compound is recommended and the torque should be rechecked after a period of 3 hours to allow for the spread of the compound
wt Approximate weight	110 (4)		gr (oz)	
Case style	TO-240AA			JEDEC

**ΔR Conduction (per Junction)**

(The following table shows the increment of thermal resistance R<sub>thJC</sub> when devices operate at different conduction angles than DC)

Devices	Sine half wave conduction					Rect. wave conduction					Units
	180°	120°	90°	60°	30°	180°	120°	90°	60°	30°	
IRK.56	0.11	0.13	0.16	0.22	0.32	0.09	0.14	0.17	0.23	0.32	°C/W
IRK.71	0.06	0.08	0.11	0.14	0.21	0.06	0.09	0.11	0.15	0.21	

**Ordering Information Table**

**Device Code**

<b>IRK</b>	<b>D</b>	<b>71</b>	<b>/</b>	<b>16</b>	<b>P</b>
①	②	③		④	⑤

  

- 1** - Module type
- 2** - Circuit configuration (See Circuit Configuration Table)
- 3** - Current code
- 4** - Voltage code (See Voltage Ratings Table)
- 5** - P = Lead-Free

# IRK.56, .71 Series

Bulletin I27210 03/06

## Outline Table

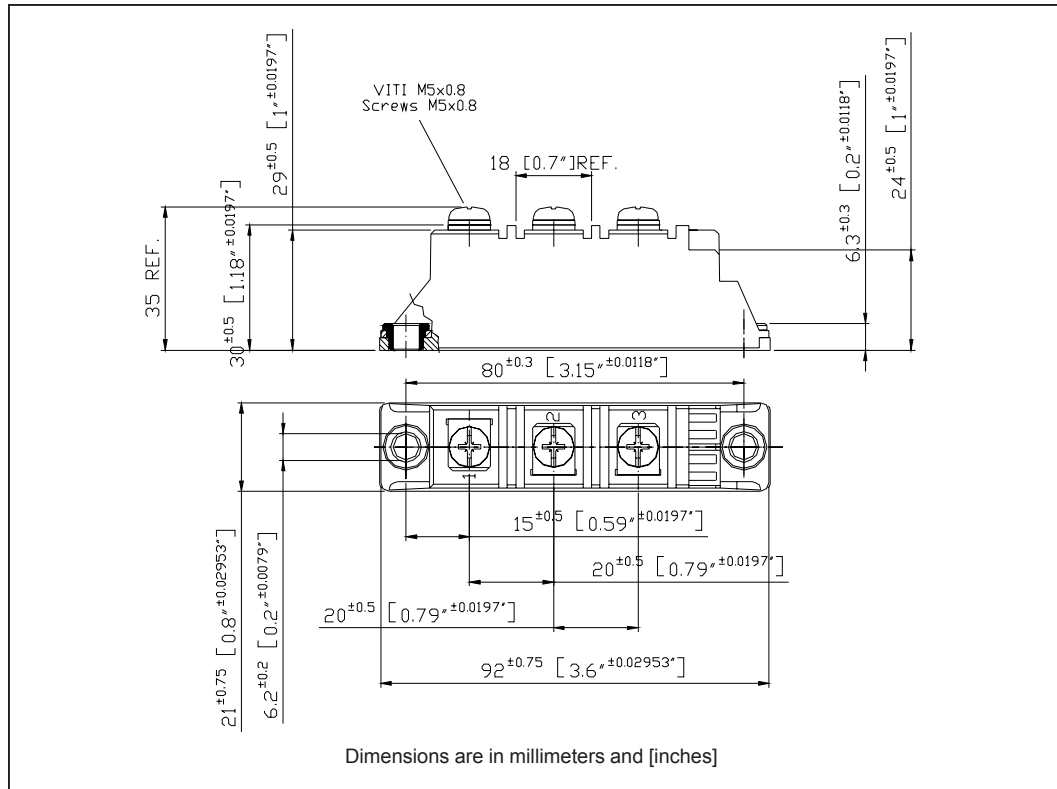

## Circuit Configuration Table

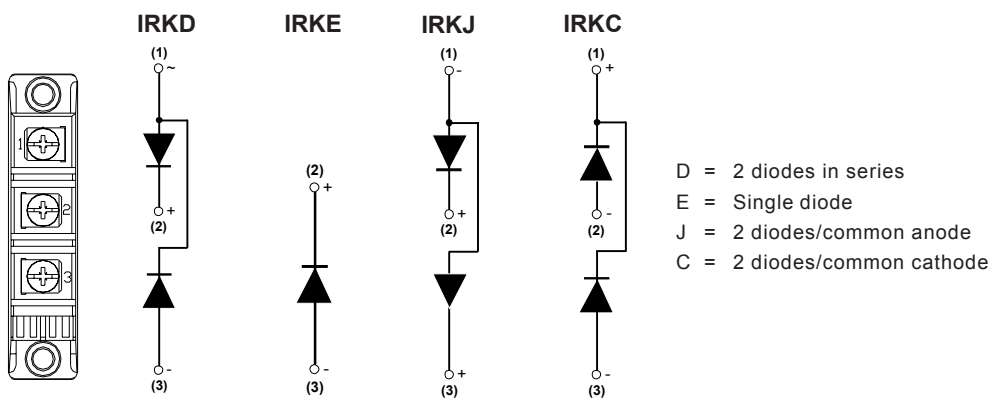

**NOTE: To order the Optional Hardware see Bulletin I27900**

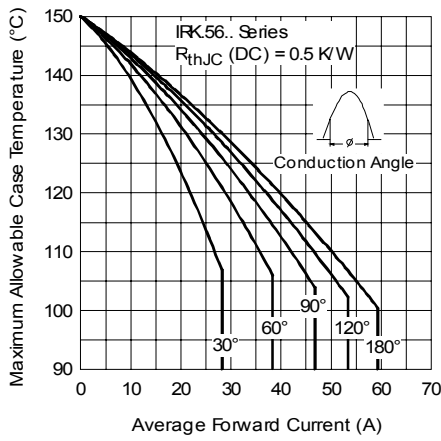

Fig. 1 - Current Ratings Characteristics

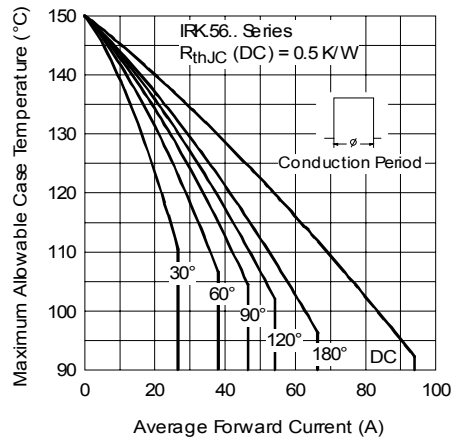

Fig. 2 - Current Ratings Characteristics

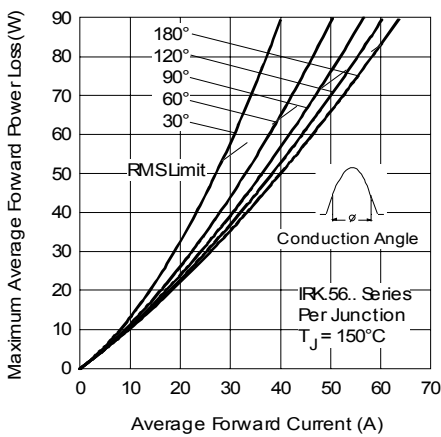

Fig. 3 - Forward Power Loss Characteristics

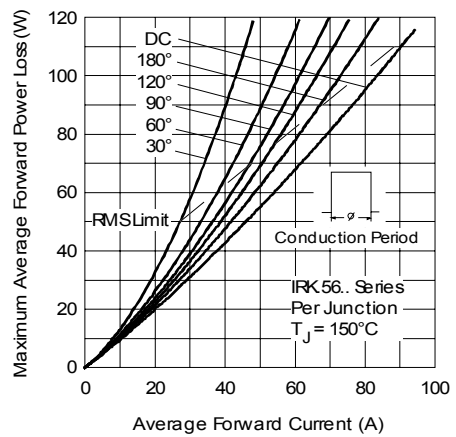

Fig. 4 - Forward Power Loss Characteristics

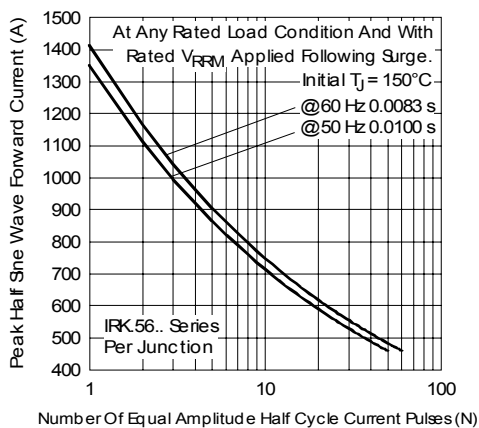

Fig. 5 - Maximum Non-Repetitive Surge Current

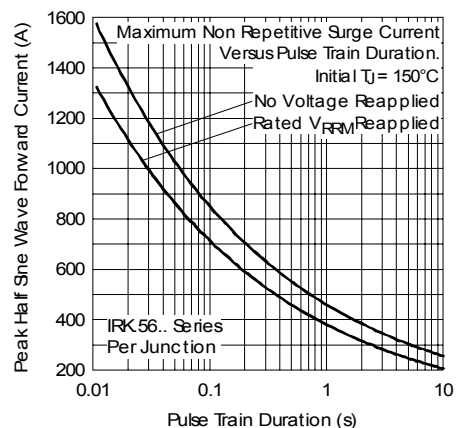

Fig. 6 - Maximum Non-Repetitive Surge Current

# IRK.56, .71 Series

Bulletin I27210 03/06

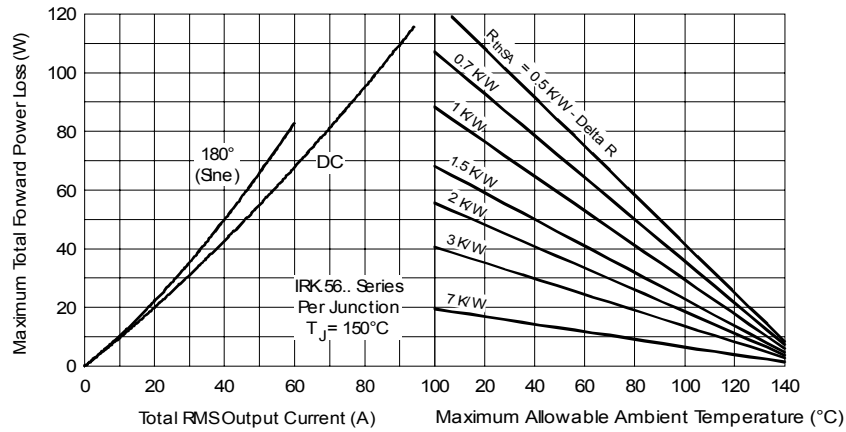

Fig. 7 - Forward Power Loss Characteristics

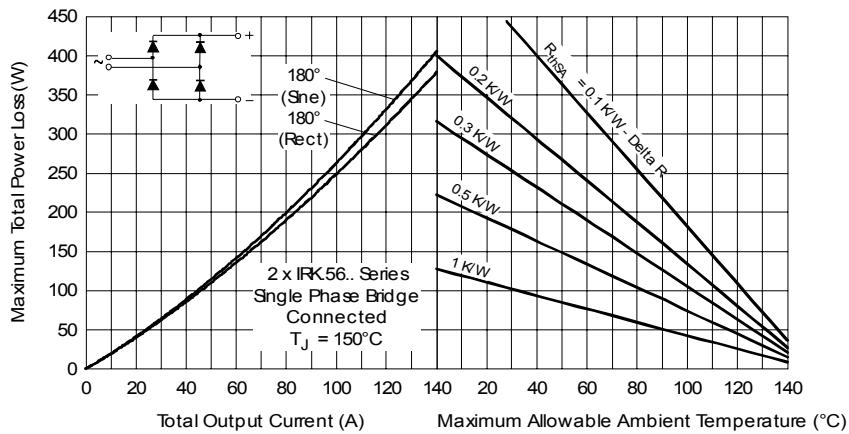

Fig. 8 - Forward Power Loss Characteristics

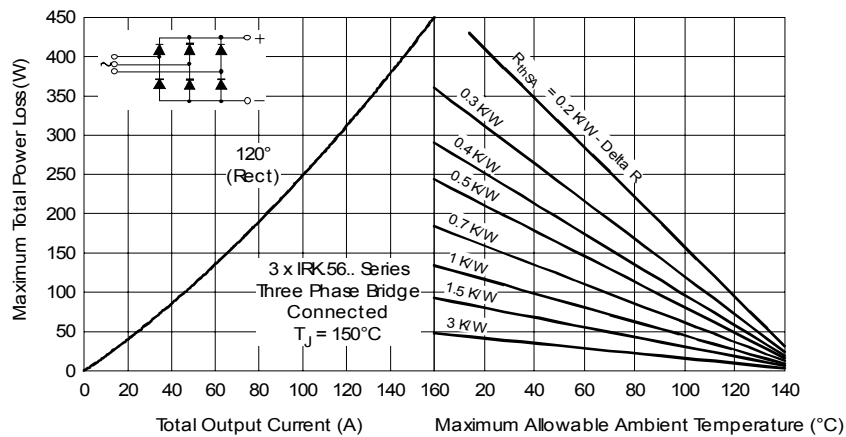

Fig. 9 - Forward Power Loss Characteristics

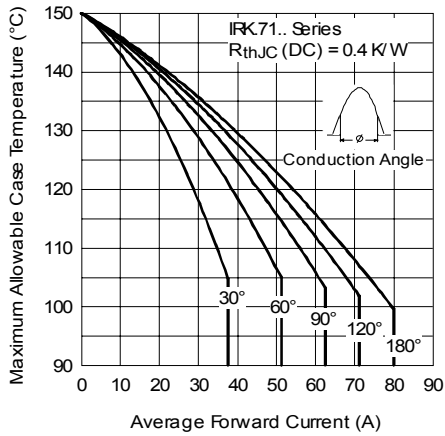

Fig. 10 - Current Ratings Characteristics

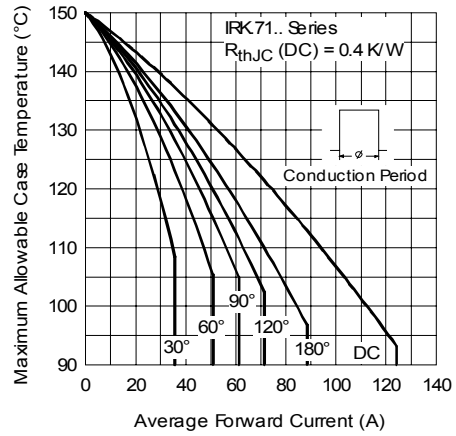

Fig. 11 - Current Ratings Characteristics

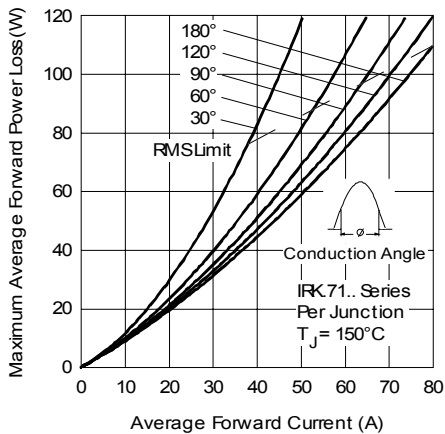

Fig. 12 - Forward Power Loss Characteristics

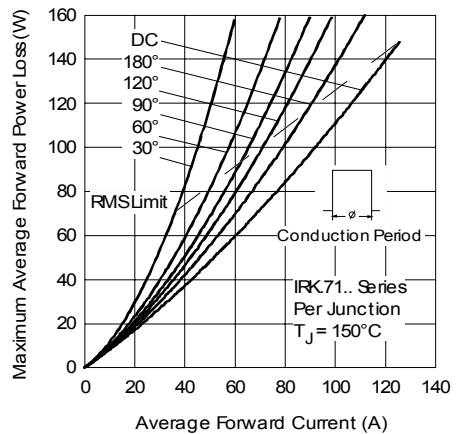

Fig. 13 - Forward Power Loss Characteristics

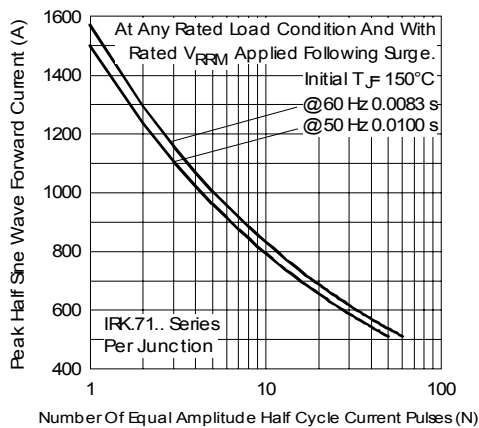

Fig. 14 - Maximum Non-Repetitive Surge Current

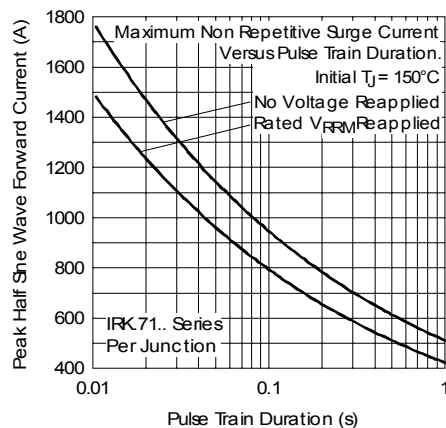

Fig. 15 - Maximum Non-Repetitive Surge Current

# IRK.56, .71 Series

Bulletin I27210 03/06

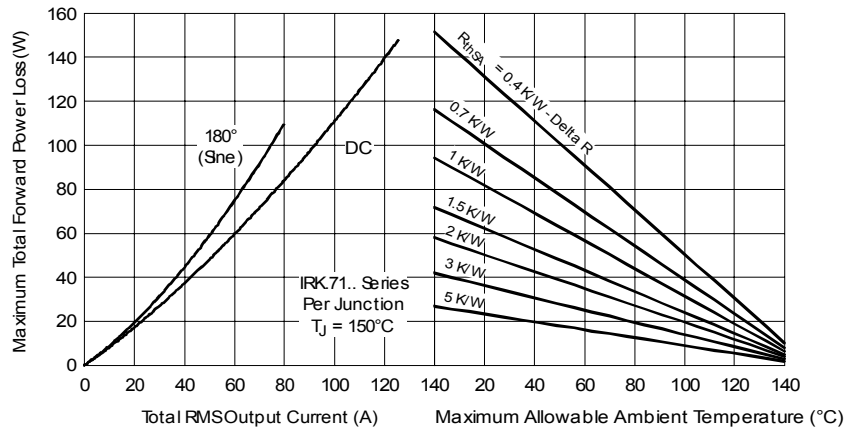

Fig. 16 - Forward Power Loss Characteristics

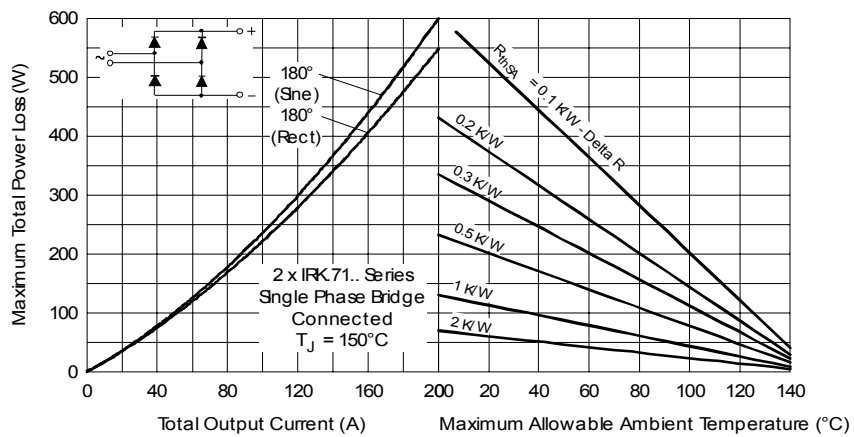

Fig. 17 - Forward Power Loss Characteristics

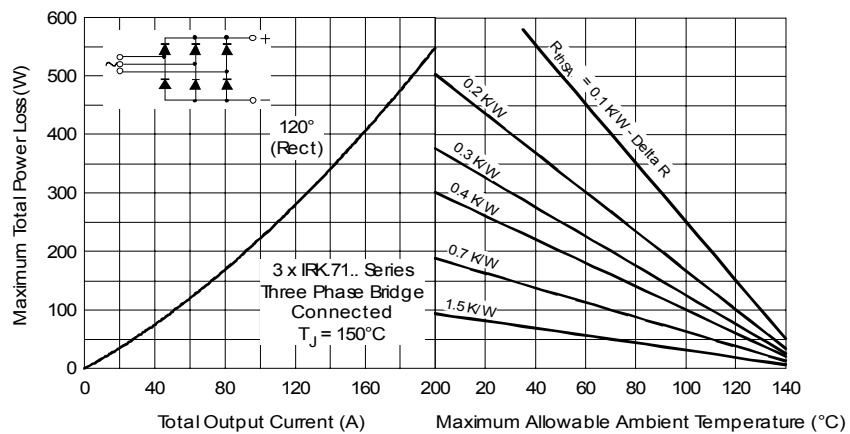

Fig. 18 - Forward Power Loss Characteristics



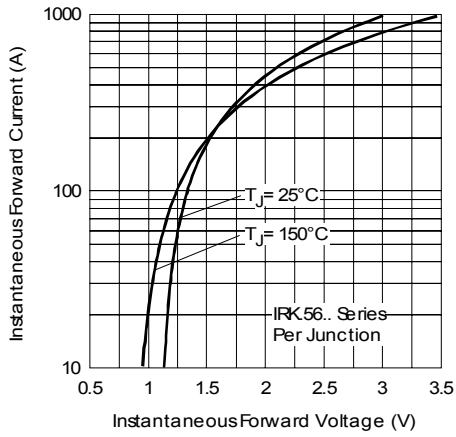

Fig. 19 - Forward Voltage Drop Characteristics

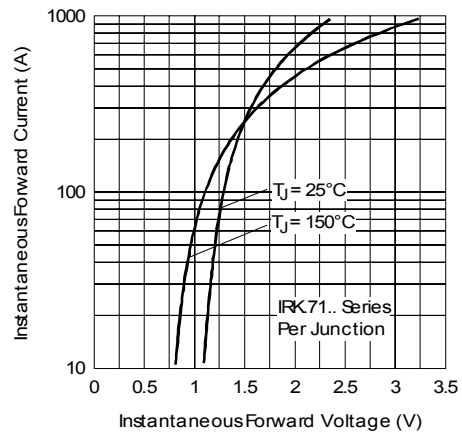

Fig. 20 - Forward Voltage Drop Characteristics

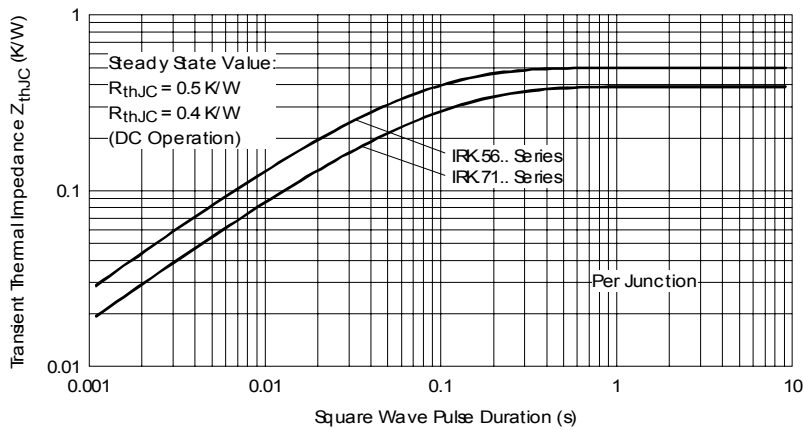

Fig. 21 - Thermal Impedance  $Z_{thJC}$  Characteristic

Data and specifications subject to change without notice.  
 This product has been designed and qualified for Industrial Level and Lead-Free.  
 Qualification Standards can be found on IR's Web site.



### Notice

The products described herein were acquired by Vishay Intertechnology, Inc., as part of its acquisition of International Rectifier's Power Control Systems (PCS) business, which closed in April 2007. Specifications of the products displayed herein are pending review by Vishay and are subject to the terms and conditions shown below.

Specifications of the products displayed herein are subject to change without notice. Vishay Intertechnology, Inc., or anyone on its behalf, assumes no responsibility or liability for any errors or inaccuracies.

Information contained herein is intended to provide a product description only. No license, express or implied, by estoppel or otherwise, to any intellectual property rights is granted by this document. Except as provided in Vishay's terms and conditions of sale for such products, Vishay assumes no liability whatsoever, and disclaims any express or implied warranty, relating to sale and/or use of Vishay products including liability or warranties relating to fitness for a particular purpose, merchantability, or infringement of any patent, copyright, or other intellectual property right.

The products shown herein are not designed for use in medical, life-saving, or life-sustaining applications. Customers using or selling these products for use in such applications do so at their own risk and agree to fully indemnify Vishay for any damages resulting from such improper use or sale.

International Rectifier®, IR®, the IR logo, HEXFET®, HEXSense®, HEXDIP®, DOL®, INTERO®, and POWIRTRAIN® are registered trademarks of International Rectifier Corporation in the U.S. and other countries. All other product names noted herein may be trademarks of their respective owners.