

**88CNQ060-G SCHOTTKY RECTIFIER**

**Applications:**

- Switching power supply • Free-Wheeling Diodes • Reverse battery protection • Converters

**Features:**

- 175°C T<sub>J</sub> operation
- Center tap module
- High purity, high temperature epoxy encapsulation for enhanced mechanical strength and moisture resistance
- Very Low forward voltage drop
- High frequency operation
- Guard ring for enhanced ruggedness and long term reliability
- New fully transfer-mould low profile, small footprint, high current package
- Green Products in Compliance with the RoHS Directive

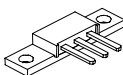
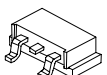
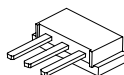
Case styles		
<p><b>88CNQ060-G</b></p>  <p><b>PRM2</b></p>	<p><b>88CNQ060SL-G</b></p>  <p><b>PRM2-SL</b></p>	<p><b>88CNQ060SM-G</b></p>  <p><b>PRM2-SM</b></p>

**Mechanical Dimensions: In Inches / mm**

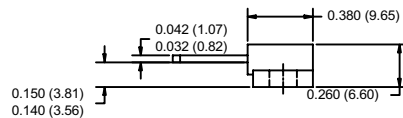
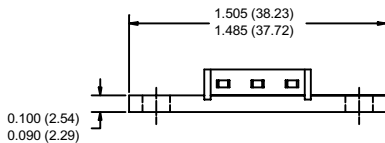
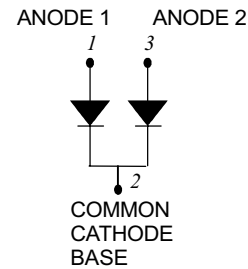
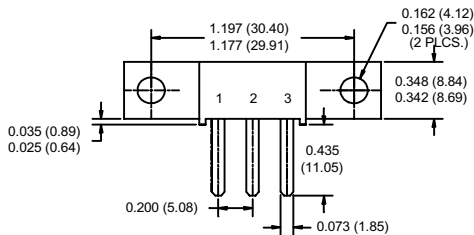

**PRM2**

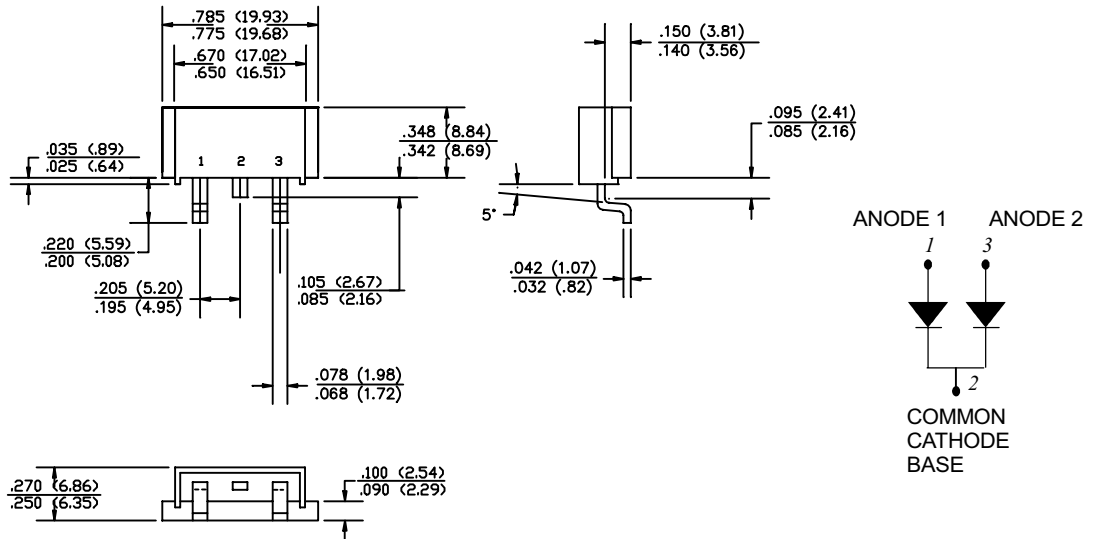

**PRM2-SL**

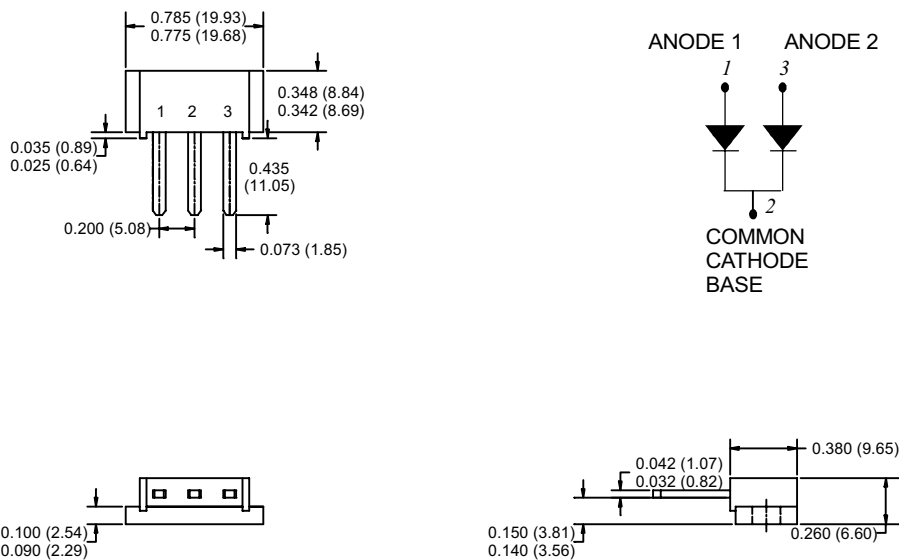

**PRM2-SM**

Data Sheet 3773, Rev. -  
Maximum Ratings:

*Green Products*

Characteristics	Symbol	Condition	Max.	Units
Peak Inverse Voltage	$V_{RWM}$	-	60	V
Max. Average Forward Current	$I_{F(AV)}$	50% duty cycle @ $T_C = 95^\circ\text{C}$ , rectangular wave form	80	A
Max. Peak One Cycle Non-Repetitive Surge Current (per leg)	$I_{FSM}$	8.3 ms, half Sine pulse	720	A
Non-Repetitive Avalanche Energy (per leg)	$E_{AS}$	$T_J = 25^\circ\text{C}$ , $I_{AS} = 1\text{ A}$ , $L = 0.57\text{ mH}$	75	mJ
Repetitive Avalanche Current (per leg)	$I_{AR}$	Current decaying linearly to zero in 1 $\mu\text{sec}$ Frequency limited by $T_J$ max. $V_A = 1.5 \times V_R$ typical	1	A

**Electrical Characteristics:**

Characteristics	Symbol	Condition	Max.	Units
Max. Forward Voltage Drop (per leg) *	$V_{F1}$	@ 40 A, Pulse, $T_J = 25^\circ\text{C}$ @ 80 A, Pulse, $T_J = 25^\circ\text{C}$	0.58 0.77	V
	$V_{F2}$	@ 40 A, Pulse, $T_J = 125^\circ\text{C}$ @ 80 A, Pulse, $T_J = 125^\circ\text{C}$	0.56 0.67	V
Max. Reverse Current (per leg) *	$I_{R1}$	@ $V_R = \text{rated } V_R$ $T_J = 25^\circ\text{C}$	0.64	mA
	$I_{R2}$	@ $V_R = \text{rated } V_R$ $T_J = 125^\circ\text{C}$	240	mA
Max. Junction Capacitance (per leg)	$C_T$	@ $V_R = 5\text{ V}$ , $T_C = 25^\circ\text{C}$ $f_{SIG} = 1\text{ MHz}$	5200	pF
Typical Series Inductance (per leg)	$L_S$	Measured lead to lead 5 mm from package body	5.5	nH
Max. Voltage Rate of Change	dv/dt	-	10,000	V/ $\mu\text{s}$

\* Pulse Width < 300 $\mu\text{s}$ , Duty Cycle <2%

**Thermal-Mechanical Specifications:**

Characteristics	Symbol	Condition	Specification	Units
Max. Junction Temperature	$T_J$	-	-55 to +175	$^\circ\text{C}$
Max. Storage Temperature	$T_{stg}$	-	-55 to +175	$^\circ\text{C}$
Maximum Thermal Resistance Junction to Case (per leg)	$R_{\theta JC}$	DC operation	0.85	$^\circ\text{C/W}$
Maximum Thermal Resistance Junction to Case (per package)	$R_{\theta JC}$	DC operation	0.42	$^\circ\text{C/W}$
Maximum Thermal Resistance, Case to Heat Sink (D61-8 Only)	$R_{\theta CS}$	Mounting surface, smooth and greased Device flatness < 5 mils	0.30	$^\circ\text{C/W}$
Approximate Weight	wt	-	7.8	g
Mounting Torque (D61-8 Only)	$T_M$	-	40 (min) 58 (max)	Kg-cm
Case Style	PRM2 PRM2-SL PRM2-SM			

**Typical Forward Characteristics**

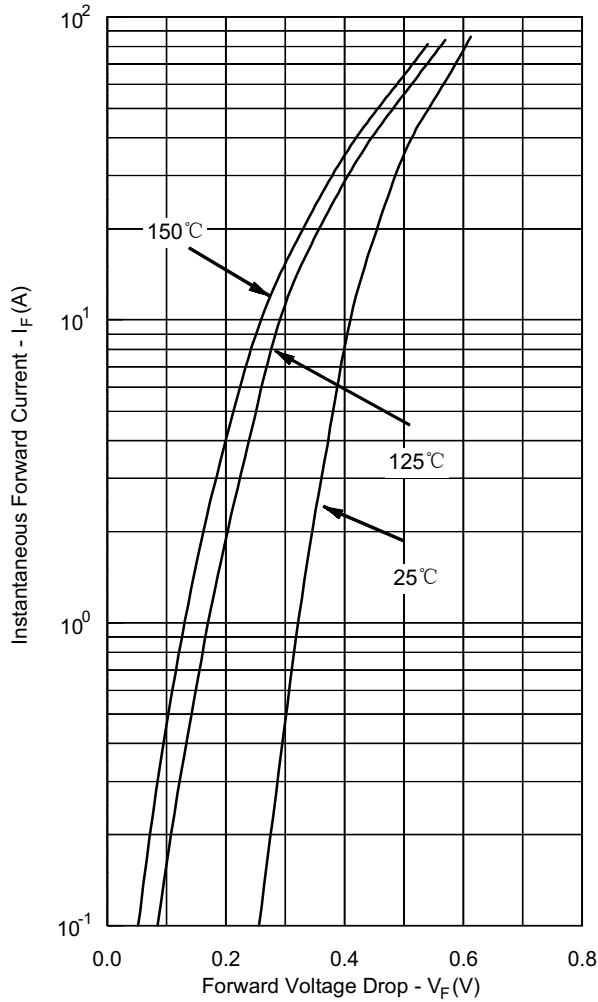

**Typical Reverse Characteristics**

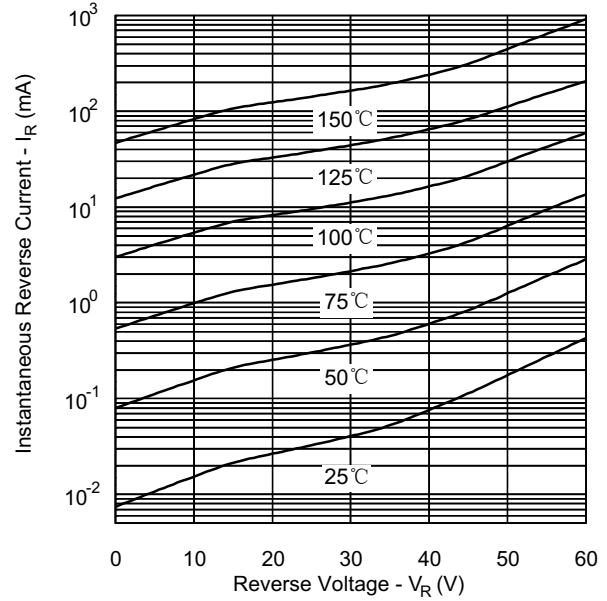

**Typical Junction Capacitance**

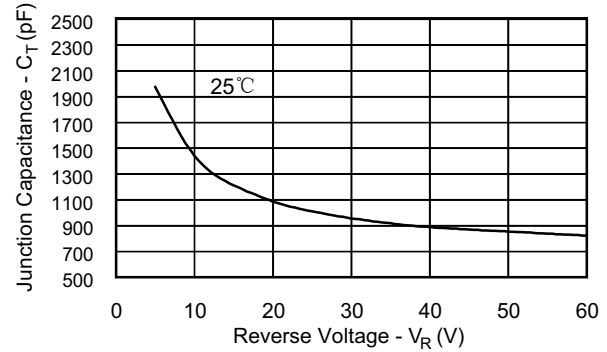

**DISCLAIMER:**

- 1- The information given herein, including the specifications and dimensions, is subject to change without prior notice to improve product characteristics. Before ordering, purchasers are advised to contact the Sensitron Semiconductor sales department for the latest version of the datasheet(s).
- 2- In cases where extremely high reliability is required (such as use in nuclear power control, aerospace and aviation, traffic equipment, medical equipment, and safety equipment), safety should be ensured by using semiconductor devices that feature assured safety or by means of users' fail-safe precautions or other arrangement.
- 3- In no event shall Sensitron Semiconductor be liable for any damages that may result from an accident or any other cause during operation of the user's units according to the datasheet(s). Sensitron Semiconductor assumes no responsibility for any intellectual property claims or any other problems that may result from applications of information, products or circuits described in the datasheets.
- 4- In no event shall Sensitron Semiconductor be liable for any failure in a semiconductor device or any secondary damage resulting from use at a value exceeding the absolute maximum rating.
- 5- No license is granted by the datasheet(s) under any patents or other rights of any third party or Sensitron Semiconductor.
- 6- The datasheet(s) may not be reproduced or duplicated, in any form, in whole or part, without the expressed written permission of Sensitron Semiconductor.
- 7- The products (technologies) described in the datasheet(s) are not to be provided to any party whose purpose in their application will hinder maintenance of international peace and safety nor are they to be applied to that purpose by their direct purchasers or any third party. When exporting these products (technologies), the necessary procedures are to be taken in accordance with related laws and regulations.