



Precision Operational Amplifier

The LM308A operational amplifier provides high input impedance, low input offset and temperature drift, and low noise. These characteristics are made possible by use of a special Super Beta processing technology. This amplifier is particularly useful for applications where high accuracy and low drift performance are essential. In addition high speed performance may be improved by employing feedforward compensation techniques to maximize slew rate without compromising other performance criteria.

The LM308A offers extremely low input offset voltage and drift specifications allowing usage in even the most critical applications without external offset nulling.

- Operation from a Wide Range of Power Supply Voltages
- Low Input Bias and Offset Currents
- Low Input Offset Voltage and Guaranteed Offset Voltage Drift Performance
- High Input Impedance

Frequency Compensation

Standard Compensation

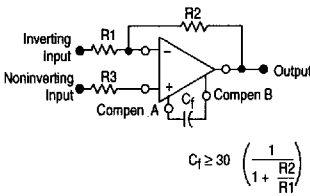

Modified Compensation

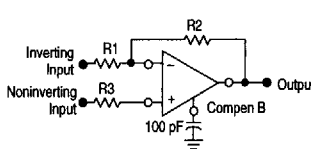

Standard Feedforward Compensation

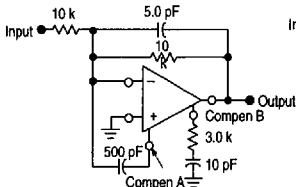

Feedforward Compensations for Decoupling Load Capacitance

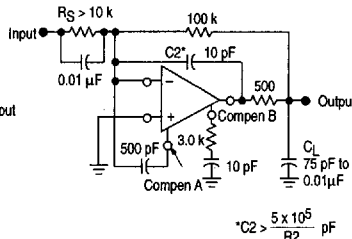

LM308A

SUPER GAIN OPERATIONAL AMPLIFIER

SEMICONDUCTOR TECHNICAL DATA

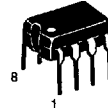

N SUFFIX
PLASTIC PACKAGE
CASE 626



D SUFFIX
PLASTIC PACKAGE
CASE 751
(SO-8)

PIN CONNECTIONS

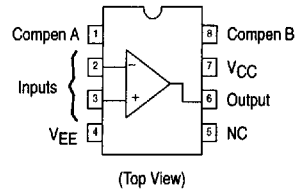

ORDERING INFORMATION

Device	Operating Temperature Range	Package
LM308AN	T _A = 0° to +70°C	Plastic DIP
LM308AD		

LM308A

MAXIMUM RATINGS ($T_A = +25^\circ\text{C}$, unless otherwise noted.)

Rating	Symbol	Value	Unit
Power Supply Voltage	V_{CC}, V_{EE}	± 18	Vdc
Input Voltage (See Note 1)	V_I	± 15	V
Input Differential Current (See Note 2)	I_{ID}	± 10	mA
Output Short Circuit Duration	t_{SC}	Indefinite	
Operating Ambient Temperature Range	T_A	0 to +70	$^\circ\text{C}$
Storage Temperature Range	T_{stg}	-65 to +150	$^\circ\text{C}$
Junction Temperature	T_J	+150	$^\circ\text{C}$

- NOTES:** 1. For supply voltages less than $\pm 15\text{ V}$, the maximum input voltage is equal to the supply voltage.
 2. The inputs are shunted with back-to-back diodes for overvoltage protection. Therefore, excessive current will flow if a differential input voltage in excess of 1.0 V is applied between the inputs, unless some limiting resistance is used.

ELECTRICAL CHARACTERISTICS (Unless otherwise noted these specifications apply for supply voltages of $+5.0\text{ V} \leq V_{CC} \leq +15\text{ V}$ and $-5.0\text{ V} \geq V_{EE} \geq -15\text{ V}$, $T_A = +25^\circ\text{C}$.)

Characteristic	Symbol	Min	Typ	Max	Unit
Input Offset Voltage	V_{IO}	-	0.3	0.5	mV
Input Offset Current	I_{IO}	-	0.2	1.0	nA
Input Bias Current	I_{IB}	-	1.5	7.0	nA
Input Resistance	r_i	10	40	-	M Ω
Power Supply Currents ($V_{CC} = +15\text{ V}$, $V_{EE} = -15\text{ V}$)	I_{CC}, I_{EE}	-	± 0.3	± 0.8	mA
Large Signal Voltage Gain ($V_{CC} = +15\text{ V}$, $V_{EE} = -15\text{ V}$, $V_O = \pm 10\text{ V}$, $R_L \geq 10\text{ k}\Omega$)	A_{VOL}	80	300	-	V/mV

The following specifications apply over the operating temperature range.

Input Offset Voltage	V_{IO}	-	-	0.73	mV
Input Offset Current	I_{IO}	-	-	1.5	nA
Average Temperature Coefficient of Input Offset Voltage $T_A (\text{min}) \leq T_A \leq T_A (\text{max})$	$\Delta V_{IO}/\Delta T$	-	1.0	5.0	$\mu\text{V}/^\circ\text{C}$
Average Temperature Coefficient of Input Offset Current	$\Delta I_{IO}/\Delta T$	-	2.0	10	$\text{pA}/^\circ\text{C}$
Input Bias Current	I_{IB}	-	-	10	nA
Large Signal Voltage Gain ($V_{CC} = +15\text{ V}$, $V_{EE} = -15\text{ V}$, $V_O = \pm 10\text{ V}$, $R_L \geq 10\text{ k}\Omega$)	A_{VOL}	60	-	-	V/mV
Input Voltage Range ($V_{CC} = +15\text{ V}$, $V_{EE} = -15\text{ V}$)	V_{ICR}	± 14	-	-	V
Common Mode Rejection ($R_S \leq 50\text{ k}\Omega$)	CMR	96	110	-	dB
Supply Voltage Rejection ($R_S \leq 50\text{ k}\Omega$)	PSR	96	110	-	dB
Output Voltage Range ($V_{CC} = +15\text{ V}$, $V_{EE} = -15\text{ V}$, $R_L = 10\text{ k}\Omega$)	V_{OR}	± 13	± 14	-	V

Figure 1. Input Bias and Input Offset Currents

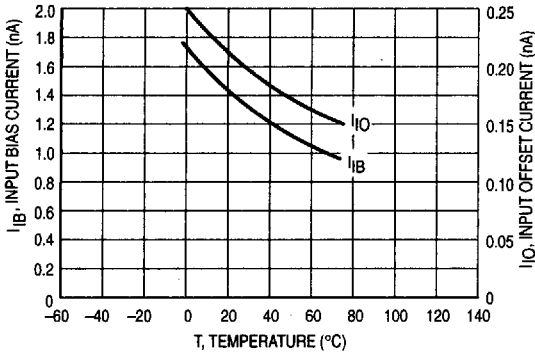

Figure 2. Maximum Equivalent Input Offset Voltage Error versus Input Resistance

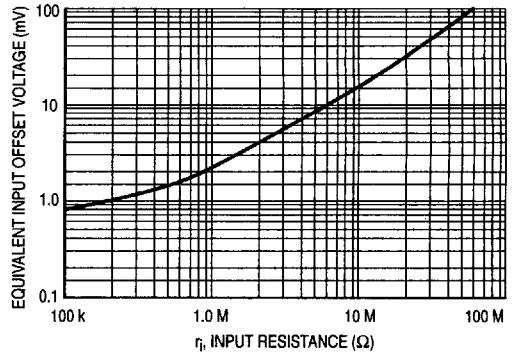

Figure 3. Voltage Gain versus Supply Voltages

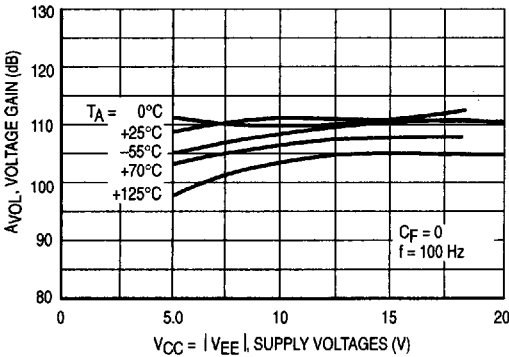

Figure 4. Power Supply Currents versus Power Supply Voltages

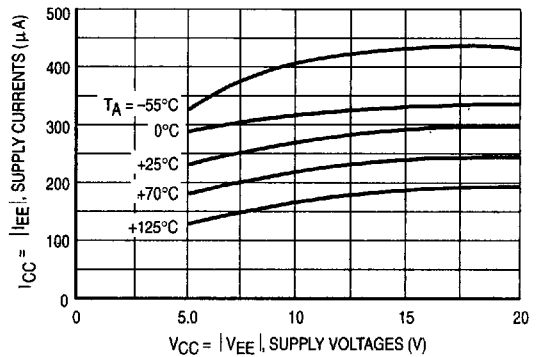

Figure 5. Open Loop Frequency Response

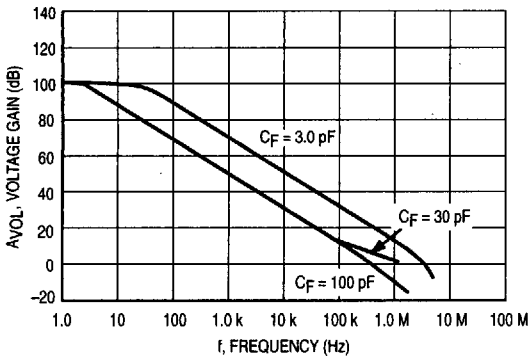
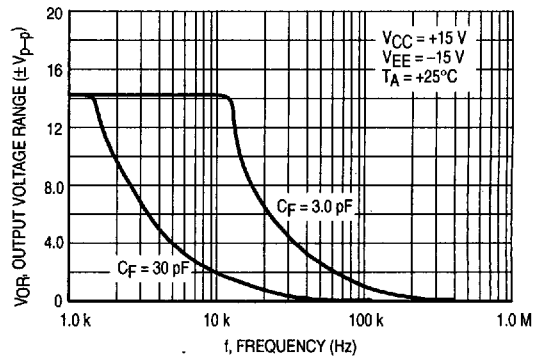

Figure 6. Large Signal Frequency Response



LM308A

SUGGESTED DESIGN APPLICATIONS

INPUT GUARDING

Special care must be taken in the assembly of printed circuit boards to take full advantage of the low input currents of the LM308A amplifier. Boards must be thoroughly cleaned with alcohol and blown dry with compressed air. After cleaning, the boards should be coated with epoxy or silicone rubber to prevent contamination.

Even with properly cleaned and coated boards, leakage currents may cause trouble at +125°C, particularly since the input pins are adjacent to pins that are at supply potentials. This leakage can be significantly reduced by using guarding to lower the voltage difference between the inputs and adjacent metal runs. The guard, which is a conductive ring surrounding the inputs, is connected to a low-impedance point that is at approximately the same voltage as the inputs. Leakage currents from high voltage pins are then absorbed by the guard.

2

Figure 7. Fast (1) Summing Amplifier with Low Input Current

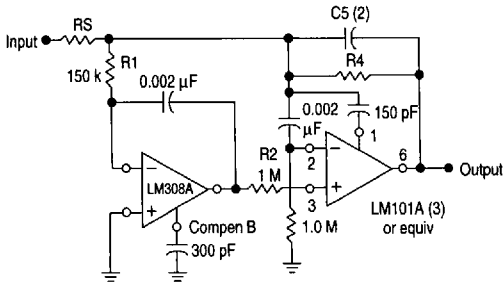

- (1) Power Bandwidth: 250 kHz
Small Signal Bandwidth: 3.5 MHz
Slew Rate: 10 V/μs

- (3) In addition to increasing speed, the LM101A raises high and low frequency gain, increases output drive capability and eliminates thermal feedback.

$$(2) C5 = \frac{6 \times 10^{-8}}{R1}$$

Figure 8. Sample and Hold

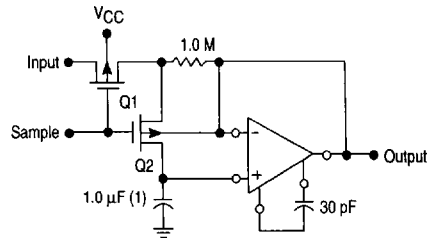

- (1) Teflon, Polyethylene or Polycarbonate Dielectric Capacitor

Figure 9. Connection of Input Guards

Inverting Amplifier

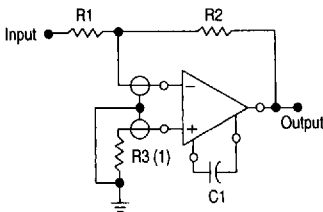

- (1) Used to compensate for large source resistances.

Follower

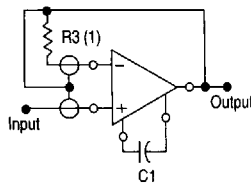

Noninverting Amplifier

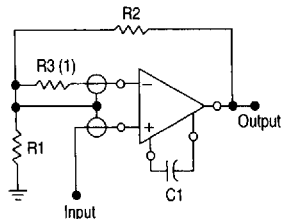

- Note: $\frac{R1 R2}{R1 + R2}$ must be an impedance.

6367253 0100347 830

LM308A

Representative Circuit Schematic

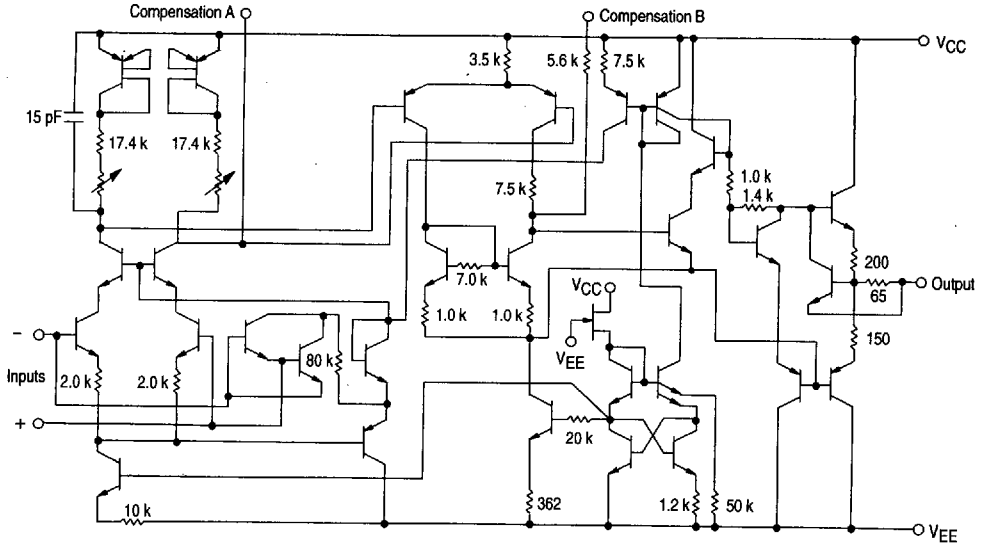

6367253 0100348 777