



# T-1<sup>3</sup>/<sub>4</sub> (5mm) Solid State Lamps

- LTL-307R/307RE Red
- LTL-307P/307PE Bright Red
- LTL-307E/307EE High Efficiency Red
- LTL-307G/307GE Green
- LTL-307Y/307YE Yellow

## Feature

- High Intensity.
- Popular T-1<sup>3</sup>/<sub>4</sub> diameter package.
- Selected minimum intensities.
- Wide viewing angle.
- General purpose leads.
- Reliable and rugged.

## Description

The Red source color devices are made with Gallium Arsenide Phosphide on Gallium Arsenide Red Light Emitting Diode.

The Bright Red source color devices are made with Gallium Phosphide on Gallium Phosphide Red Light Emitting Diode.

The High Efficiency Red and Orange source color devices are made with Gallium Arsenide Phosphide on Gallium Phosphide Orange Light Emitting Diode.

The Green source color devices are made with Gallium Phosphide on Gallium Phosphide Green Light Emitting Diode.

The Yellow source color devices are made with Gallium Arsenide Phosphide on Gallium Phosphide Yellow Light Emitting Diode.

## Package Dimensions

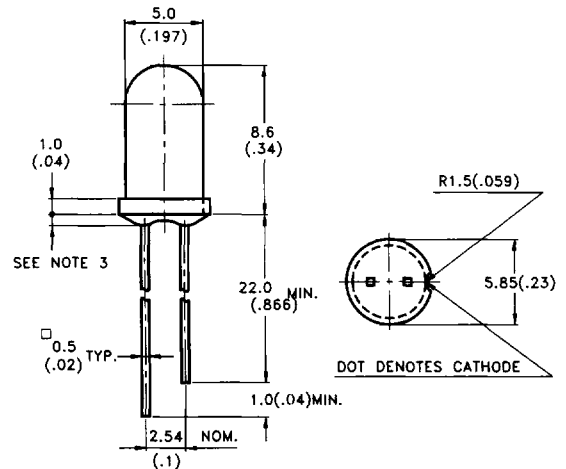

### Notes:

1. All dimensions are in millimeters (inches).
2. Tolerance is  $\pm 0.25\text{mm}$  (0.10") unless otherwise noted.
3. Protruded resin under flange is 1.0mm (.04") max.
4. Lead spacing is measured where the leads emerge from the package.
5. Specifications are subject to change without notice.

## Devices

Part No. LTL-	Lens		Source Color
	Color	Diffusion	
307R 307RE	Red	Diffused Transparent	Red
307P 307PE	Red	Diffused Transparent	Bright Red
307E 307EE	Red	Diffused Transparent	Hi. Eff. Red
307G 307GE	Green	Diffused Transparent	Green
307Y 307YE	Yellow	Diffused Transparent	Yellow

## Absolute Maximum Ratings at Ta=25 °C

Parameter	Red	Bright Red	Green	Yellow	Hi. Eff. Red Orange	Unit
Power Dissipation	80	40	100	60	100	mW
Peak Forward Current (1/10 Duty Cycle, 0.1ms Pulse Width)	200	60	120	80	120	mA
Continuous Forward Current	40	15	30	20	30	mA
Derating Linear From 50 °C	0.5	0.2	0.4	0.25	0.4	mA/ °C
Reverse Voltage	5	5	5	5	5	V
Operating Temperature Range	-55 °C to +100 °C					
Storage Temperature Range	-55 °C to +100 °C					
Lead Soldering Temperature [1.6mm (.063") From Body]	260 °C for 5 Seconds					

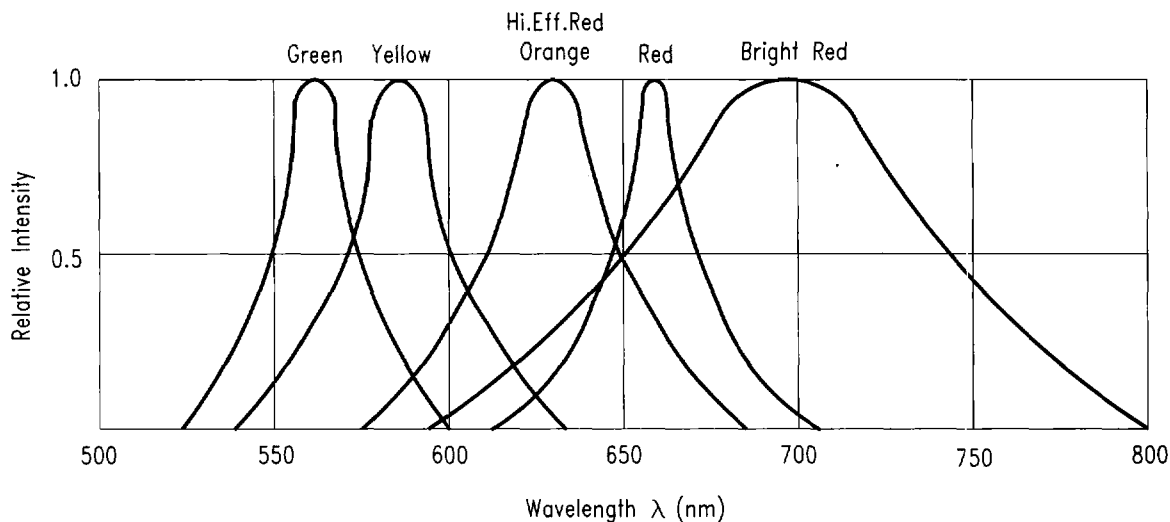

Fig.1 RELATIVE INTENSITY VS. WAVELENGTH

## Electrical /Optical Characteristics and Curves at Ta=25 °C

Parameter	Symbol	Part No. LTL-	Min.	Typ.	Max.	Unit	Test Condition	
Luminous Intensity	I <sub>v</sub>	307R	0.5	1.7		mcd	I <sub>F</sub> = 10mA Note 1	
		307P	1.7	5.6				
		307E	5.6	19				
		307G	5.6	19				
		307Y	8.7	29				
Viewing Angle	2 θ ½	307R				deg	Note 2 (Fig.7)	
		307P			50			
		307E						
		307G						
		307Y						
Peak Emission Wavelength	λ <sub>P</sub>	307R		655		nm	Measurement @ Peak (Fig.1)	
		307P		697				
		307E		635				
		307G		565				
		307Y		585				
Dominant Wavelength	λ <sub>d</sub>	307R		651		nm	Note 3	
		307P		657				
		307E		621.				
		307G		569				
		307Y		588				
Spectral Line Half Width	Δ λ	307R		24		nm		
		307P		90				
		307E		40				
		307G		30				
		307Y		35				
Forward Voltage	V <sub>F</sub>	307R		1.7	2.0	V	I <sub>F</sub> = 20mA	
		307P		2.1	2.8			
		307E		2.0	2.8			
		307G		2.1	2.8			
		307Y		2.1	2.8			
Reverse Current	I <sub>R</sub>	307R				100	V <sub>R</sub> = 5V	
		307P						
		307E						
		307G						
		307Y						
Capacitance	C	307R		30		PF	V <sub>F</sub> =0 f=1MHZ	
		307P		55				
		307E		20				
		307G		35				
		307Y		15				

### Notes:

- Luminous intensity is measured with a light sensor and filter combination that approximates the CIE eye-response curve.
- θ½ is the off-axis angle at which the luminous intensity is half the axial luminous intensity.
- The dominant wavelength, λ<sub>d</sub> is derived from the CIE chromaticity diagram and represents the single wavelength which defines the color of the device.

## Electrical /Optical Characteristics and Curves at Ta=25 °C

Parameter	Symbol	Part No. LTL-	Min.	Typ.	Max.	Unit	Test Condition
Luminous Intensity	Iv	307RE	1.1	3.7		mcd	If = 10mA Note 1
		307PE	2.5	8.7			
		307EE	29	90			
		307GE	19	60			
		307YE	12.6	40			
Viewing Angle	2 θ 1/2	307RE				deg	Note 2 (Fig.15)
		307PE		40			
		307EE					
		307GE					
		307YE					
Peak Emission Wavelength	λP	307RE		655		nm	Measurement @ Peak (Fig.1)
		307PE		697			
		307EE		635			
		307GE		565			
		307YE		585			
Dominant Wavelength	λd	307RE		651		nm	Note 3
		307PE		657			
		307EE		621			
		307GE		569			
		307YE		588			
Spectral Line Half Width	Δ λ	307RE		24		nm	
		307PE		90			
		307EE		40			
		307GE		30			
		307YE		35			
Forward Voltage	VF	307RE		1.7	2.0	V	If = 20mA
		307PE		2.1	2.8		
		307EE		2.0	2.8		
		307GE		2.1	2.8		
		307YE		2.1	2.8		
Reverse Current	IR	307RE				100	μA
		307PE					
		307EE					
		307GE					
		307YE					
Capacitance	C	307RE		30		PF	VF=0 f=1MHZ
		307PE		55			
		307EE		20			
		307GE		35			
		307YE		15			

### Notes:

- Luminous intensity is measured with a light sensor and filter combination that approximates the CIE eye-response curve.
- θ 1/2 is the off-axis angle at which the luminous intensity is half the axial luminous intensity.
- The dominant wavelength, λd is derived from the CIE chromaticity diagram and represents the single wavelength which defines the color of the device.

# Typical Electrical / Optical Characteristic Curves (25 °C Ambient Temperature Unless Otherwise Noted)

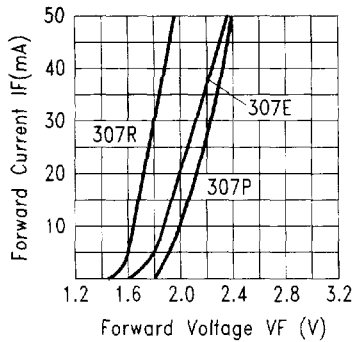

Fig.2 FORWARD CURRENT VS. FORWARD VOLTAGE

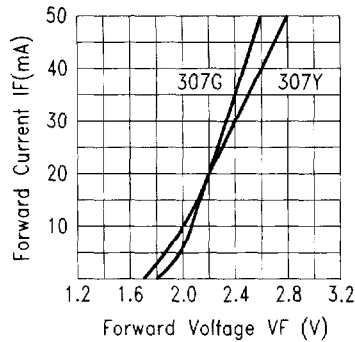

Fig.3 FORWARD CURRENT VS. FORWARD VOLTAGE

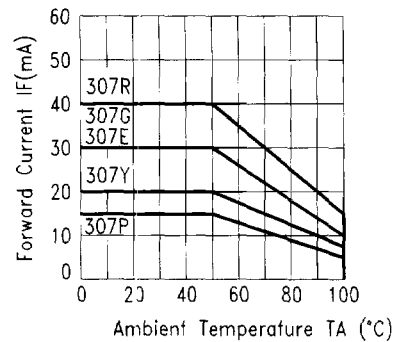

Fig.4 FORWARD CURRENT DERATING CURVE

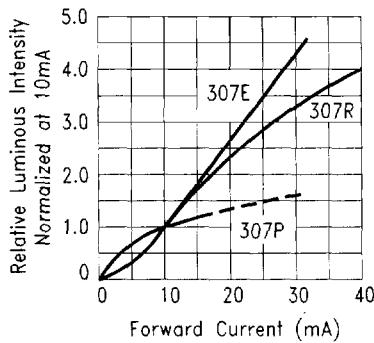

Fig.5 RELATIVE LUMINOUS INTENSITY VS. FORWARD CURRENT

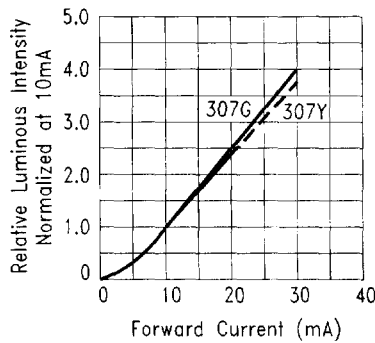

Fig.6 RELATIVE LUMINOUS INTENSITY VS. FORWARD CURRENT

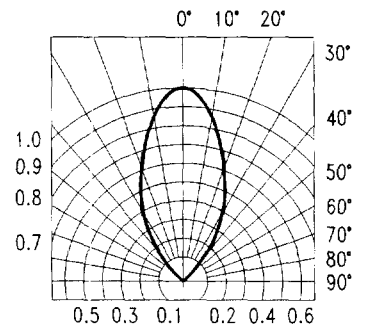

Fig.7 SPATIAL DISTRIBUTION

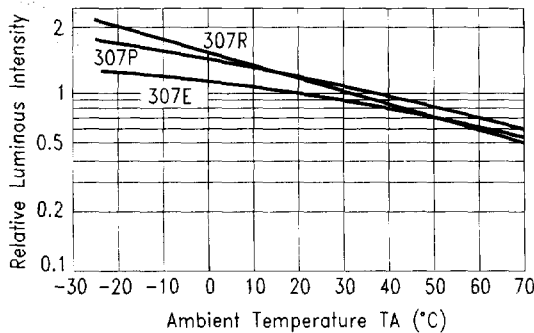

Fig.8 LUMINOUS INTENSITY VS. AMBIENT TEMPERATURE

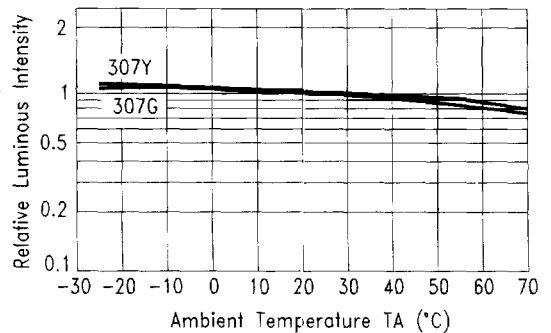

Fig.9 LUMINOUS INTENSITY VS. AMBIENT TEMPERATURE

# Typical Electrical / Optical Characteristic Curves (25 °C Ambient Temperature Unless Otherwise Noted)

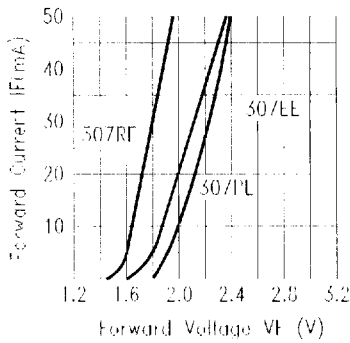

Fig.10 FORWARD CURRENT VS. FORWARD VOLTAGE

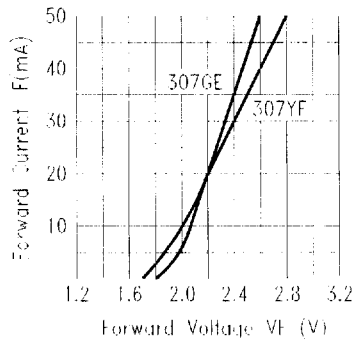

Fig.11 FORWARD CURRENT VS. FORWARD VOLTAGE

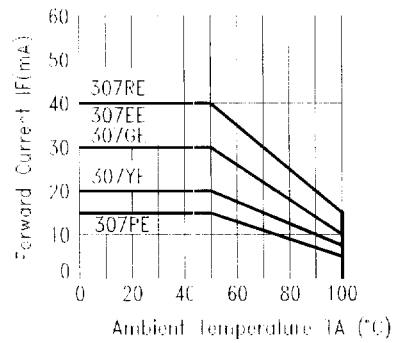

Fig.12 FORWARD CURRENT DERATING CURVE

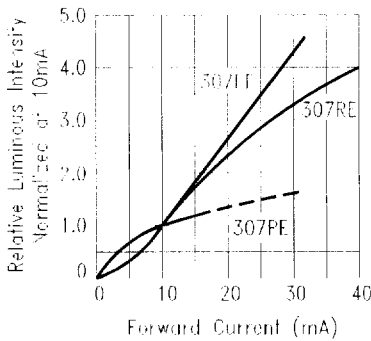

Fig.13 RELATIVE LUMINOUS INTENSITY VS. FORWARD CURRENT

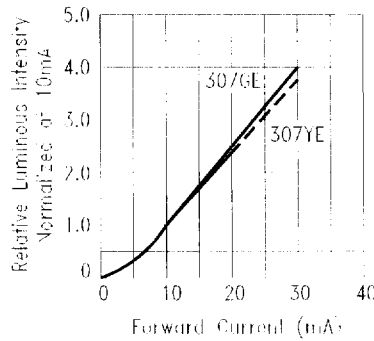

Fig.14 RELATIVE LUMINOUS INTENSITY VS. FORWARD CURRENT

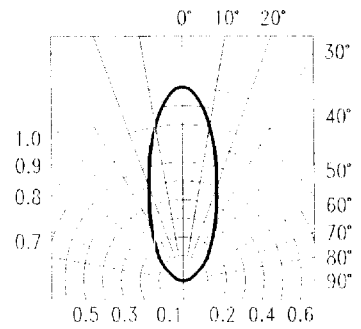

Fig.15 SPATIAL DISTRIBUTION

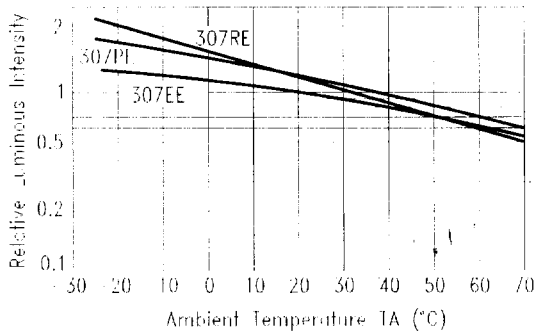

Fig.16 LUMINOUS INTENSITY VS. AMBIENT TEMPERATURE

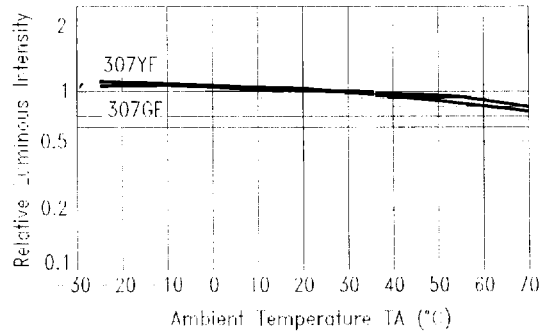

Fig.17 LUMINOUS INTENSITY VS. AMBIENT TEMPERATURE