

INTRODUCTION:

Adam Tech's MTD Series .100" & .156" Housings with IDC contacts are designed to quickly and easily mass terminate discrete wires or pre-notched flat cable. Our stamped contacts are designed to feature a precision, gas tight IDC connection at the wire end and a high pressure, smooth wiping action connection on the mating connector end. Both are available with optional cover in feed through or closed end styles.

FEATURES:

Easily mass terminates discrete wire and pre-notched flat cable
Housings have pre-inserted IDC contacts
High performance Gas tight IDC connection
Optional Feed through or Closed end cover

SPECIFICATIONS:

Material:

Insulator: Nylon 66, rated UL94V-2
Insulator Color: Natural
Contacts: Phosphor bronze and Brass

Contact Plating:

Tin over copper underplate overall

Electrical:

Operation voltage: 250V AC max.
Current rating:
.100" centers: 4. Amp max.
.156" centers: 6 Amp max.
Insulation resistance: 1000 MΩ min.
Dielectric withstanding voltage: 1000V AC for 1 minute

Mechanical:

Mating force:
.100" & .156" Center: 1.3 lbs max
Unmating force:
.100" Center: 0.5 lbs min
.156" Center: 1.3 lbs min
.100" Centers: Wire size: 28 Awg to 22 Awg
.156" Centers: Wire size: 26 Awg to 18 Awg

Temperature Rating:

Operating temperature: -40°C to +105°C

PACKAGING:

Anti-ESD plastic bags

APPROVALS AND CERTIFICATIONS:

UL Recognized & CSA Certified, File no. E224053



ORDERING INFORMATION CONNECTOR

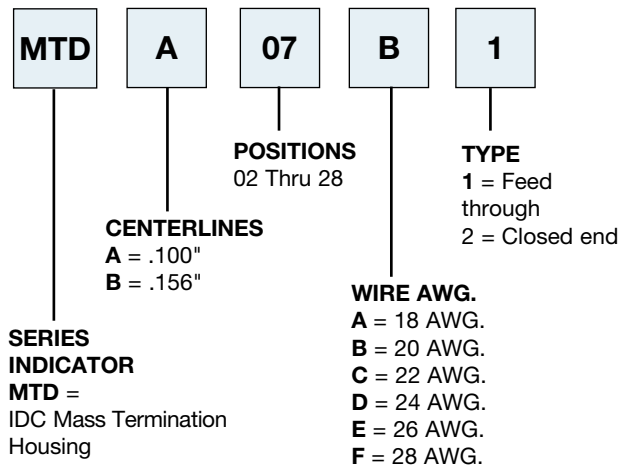

ORDERING INFORMATION COVER

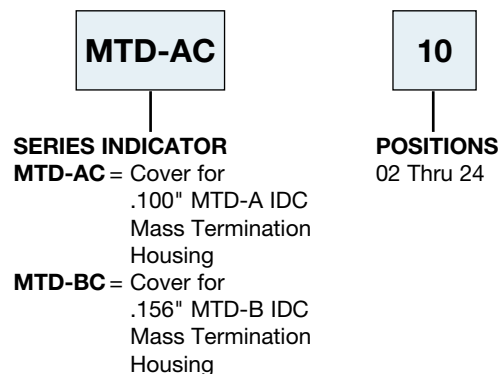

MTD-A .100" CENTERLINE

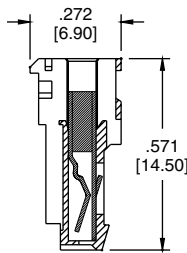
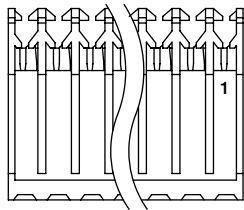
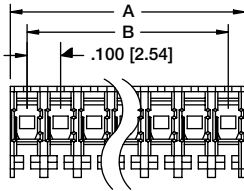

MTD-A-04-D-1



MTD-A-07-D-1

A = .100 [2.54] X No of Positions
B = .100 [2.54] X No of Spaces

Available wire sizes: 22, 24, 26 & 28 AWG.

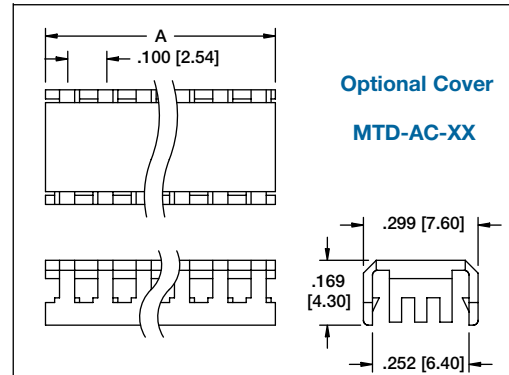

Optional Cover
MTD-AC-XX

MTD-B .156" CENTERLINE

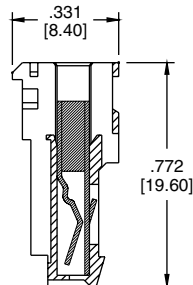
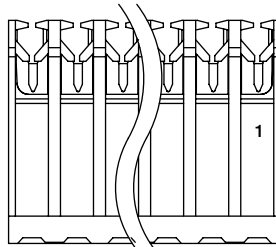
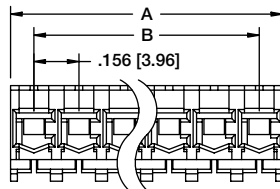

MTD-B-07-B-1



A = .156 [3.96] X No of Positions
B = .156 [3.96] X No of Spaces

Available wire sizes: 18, 20, 22, & 24 AWG.

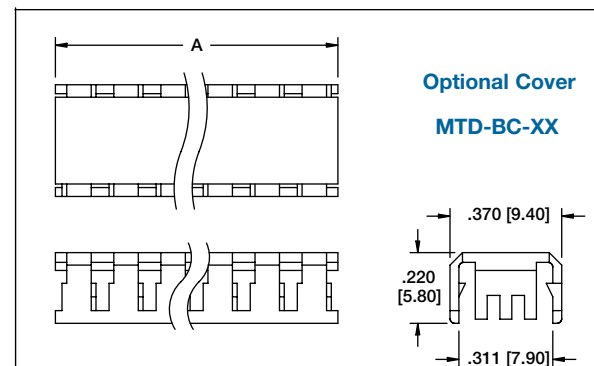

Optional Cover
MTD-BC-XX