

RF & MICROWAVE TRANSISTORS
UHF SMALL SIGNAL

- HIGH F (T) – 6 GHz
- VERY LOW NOISE
- ALL GOLD METALLIZATION
- HERMETIC PACKAGE

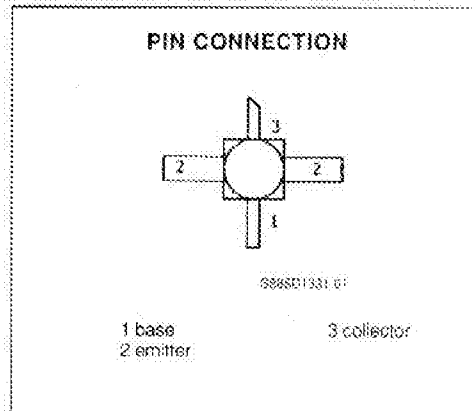
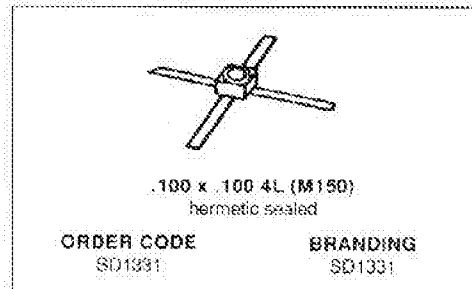

DESCRIPTION

The SD1331 is a gold metallized NPN silicon transistor featuring high gain and low noise. It utilizes an all gold system and a ceramic hermetic package suitable for HI REL and military applications.

ABSOLUTE MAXIMUM RATINGS (T_{case} = 25°C)

Symbol	Parameter	Value	Unit
V _{CB0}	Collector - Base Voltage	15.0	V
V _{CE0}	Collector - Emitter Voltage	12.0	V
V _{EB0}	Emitter - Base Voltage	3.0	V
I _C	Collector Current (max.)	80	A
P _{tot}	Total Device Dissipation at + 25°C	150	W
T _{stg}	Storage and Junction Temperatures	- 65 to + 200	°C
T _J		+ 200	°C

THERMAL DATA

R _{th(j-c)}	Junction-case Thermal Resistance	200	°C/W
----------------------	----------------------------------	-----	------

SD1331

ELECTRICAL CHARACTERISTICS (T_{case} = 25°C)

STATIC

Symbol	Test Conditions		Value			Unit
			Min.	Typ.	Max.	
BV _{CE0}	I _C = 0.1mA	I _E = 0	15			V
BV _{CE0}	I _C = 1.0mA	I _E = 0	12			V
BV _{EB0}	I _C = 0.1mA	I _C = 0	3			V
h _{FE}	V _{CE} = 5.0V	I _C = 30mA	40			

DYNAMIC

Symbol	Test Conditions			Value			Unit
				Min.	Typ.	Max.	
F _T	F = 1000MHz	V _{CE} = 5.0V	I _C = 30mA		5.5		GHz
N. F.	F = 1000MHz	V _{CE} = 5.0V	I _C = 5.0mA		2.0		dB
G _{max}	F = 1000MHz	V _{CE} = 5.0V	I _C = 30mA		15.5		dB
C _{CB}	F = 1.0MHz	V _{CE} = 5.0V			0.65		pF

Input Power : -33.00dBm

Test Cond. (Volts/Amps)	Freq. (Hz)	S11 (Mag/angle)	S21 (dB/angle)	S12 (Mag/angle)	S22 (Mag/angle)
5.00/ 4.92m	100.00M	835.12m -42.42	22.73 154.19	32.74m 67.63	928.35m -21.14
	200.00M	796.11m -76.94	21.26 135.22	54.21m 51.33	780.35m -38.38
	300.00M	768.01m -101.76	19.56 121.59	65.97m 40.89	655.61m -46.20
	400.00M	751.74m -119.07	17.94 111.58	72.73m 33.99	567.75m -52.84
	500.00M	740.57m -131.32	16.48 104.15	76.54m 29.70	507.97m -57.03
	600.00M	730.40m -140.42	15.14 98.34	79.00m 27.05	467.62m -59.95
	700.00M	721.62m -147.59	13.98 93.46	81.01m 25.08	440.70m -62.29
	800.00M	713.56m -153.72	12.93 89.40	82.47m 23.84	420.99m -64.01
	900.00M	706.38m -159.09	11.99 85.72	84.06m 22.85	406.17m -65.53
	1.00G	703.14m -163.93	11.14 82.37	84.70m 22.18	396.57m -66.96
	1.20G	706.00m -172.02	9.62 75.94	86.27m 21.96	384.67m -70.08
	1.40G	712.30m -178.18	8.28 69.40	88.96m 21.84	376.36m -73.03
	1.60G	713.10m 177.16	7.28 64.26	90.00m 22.85	375.17m -75.08
	1.80G	708.43m 172.51	6.39 59.41	91.25m 23.92	367.64m -77.65
	2.00G	708.75m 167.47	5.49 55.39	93.05m 26.10	354.18m -80.68
	2.20G	723.80m 163.07	4.63 51.59	95.68m 26.95	339.58m -86.05
	2.40G	743.57m 160.00	3.83 47.16	96.72m 28.21	335.74m -89.69
	2.60G	755.42m 157.57	3.07 42.35	98.13m 30.24	345.20m -93.22
	2.80G	767.59m 153.62	2.49 38.92	102.90m 32.43	354.23m -103.22
	3.00G	764.43m 147.14	2.39 36.89	108.68m 32.13	347.20m -106.27
5.00/ 10.00m	100.00M	731.87m -63.58	27.15 145.30	28.20m 60.40	843.22m -32.14
	200.00M	720.68m -184.41	24.62 124.14	41.59m 44.07	628.52m -50.96
	300.00M	717.81m -127.45	22.21 111.61	47.39m 36.50	490.09m -61.35
	400.00M	717.58m -141.37	20.18 103.34	50.80m 32.79	407.23m -67.69
	500.00M	715.55m -150.78	18.49 97.36	52.99m 31.44	356.48m -71.66
	600.00M	711.68m -157.87	17.05 92.87	55.01m 31.35	323.69m -74.25
	700.00M	708.21m -163.02	15.80 88.81	56.98m 31.39	303.05m -75.98
	800.00M	703.43m -167.63	14.71 85.52	59.10m 32.15	288.10m -77.19
	900.00M	708.77m -171.85	13.74 82.58	61.29m 32.71	277.11m -78.12
	1.00G	701.80m -175.64	12.85 79.81	63.11m 33.43	269.94m -78.97
	1.20G	706.85m 178.10	11.29 74.01	67.45m 35.26	262.12m -80.86
	1.40G	713.32m 173.27	9.94 68.87	72.49m 36.42	258.10m -82.52
	1.60G	718.38m 169.57	8.91 64.19	77.25m 38.38	256.05m -82.76
	1.80G	704.32m 165.93	8.82 59.67	82.30m 39.66	250.54m -83.99
	2.00G	705.88m 160.75	7.16 56.14	87.86m 41.64	328.61m -86.30
	2.20G	723.22m 156.86	6.92 52.89	93.64m 42.07	226.60m -91.38
	2.40G	742.92m 154.37	5.52 48.93	98.01m 42.62	224.85m -98.96
	2.60G	754.17m 152.53	4.78 44.70	102.39m 43.87	236.86m -105.35
	2.80G	765.80m 148.77	4.24 41.30	110.01m 44.74	247.39m -108.54
	3.00G	758.37m 142.21	4.12 38.56	118.50m 43.47	241.56m -110.48

S-PARAMETERS

SD1331

Input Power : - 33.00dBm (continued)

Test Cond. (Volts/Amps)	Freq. (Hz)	S11 (Mag/angle)	S21 (dB/angle)	S12 (Mag/angle)	S22 (Mag/angle)
5.00/ 29.99m	100.00M	623.54m-110.68	31.06 128.88	18.43m 50.00	650.72m -48.70
	200.00M	691.40m-143.31	26.78 109.65	23.61m 40.28	408.85m -66.35
	300.00M	712.50m-157.08	23.69 100.30	26.18m 39.79	301.33m -74.25
	400.00M	721.41m-164.88	21.37 94.47	28.62m 41.90	247.79m -78.74
	500.00M	724.17m-170.21	19.53 90.10	31.51m 44.21	218.82m -81.37
	600.00M	722.52m-174.29	18.00 86.56	34.33m 46.90	201.94m -82.65
	700.00M	721.11m-177.62	16.72 83.53	37.57m 48.72	193.03m -83.23
	800.00M	720.70m 179.30	15.60 80.92	40.72m 50.61	186.64m -83.33
	900.00M	720.33m 176.43	14.60 78.48	44.26m 51.58	182.47m -83.24
	1.00G	722.00m 173.80	13.71 76.28	47.54m 52.82	188.49m -83.23
	1.20G	729.81m 169.38	12.14 71.37	54.33m 54.44	180.74m -83.72
	1.40G	734.77m 165.81	10.76 66.68	61.67m 54.90	182.15m -84.08
	1.60G	729.56m 162.89	9.69 62.45	69.14m 56.04	184.82m -82.55
	1.80G	723.46m 159.13	8.80 58.35	76.30m 56.18	183.09m -82.56
	2.00G	728.30m 154.91	7.96 54.86	83.86m 56.99	174.02m -84.09
	2.20G	748.20m 151.69	7.11 51.85	91.29m 56.36	164.22m -89.43
	2.40G	767.22m 149.80	6.33 48.23	97.56m 55.96	164.23m -98.13
	2.60G	777.97m 148.36	5.57 44.23	103.45m 56.24	178.20m -105.15
	2.80G	790.36m 144.86	5.04 40.81	111.99m 56.05	190.91m -107.67
	3.00G	784.52m 138.05	4.89 37.76	121.81m 53.86	186.54m -108.66

Input Power : - 33.00 dBm

Test Cond. (Volts/Flops)	Freq. (Hz)	S11 (Mag/angle)	S21 (dB/angle)	S12 (Mag/angle)	S22 (Mag/angle)
TYPICAL DEVICE					
10.00/ 4.92m	100.00M	847.64m -39.88	22.71 155.29	27.93m 68.71	939.02m -17.93
	200.00M	808.51m -72.98	21.34 136.75	46.91m 53.22	808.27m -30.85
	300.00M	773.67m -97.63	19.75 123.06	57.73m 42.76	695.24m -38.99
	400.00M	752.84m-115.15	18.20 112.95	61.28m 36.02	613.49m -44.23
	500.00M	738.86m-127.81	16.77 105.37	67.95m 31.56	558.19m -47.77
	600.00M	727.07m-137.30	15.46 99.34	70.34m 29.00	522.15m -50.20
	700.00M	717.28m-144.84	14.31 94.31	71.99m 26.82	496.47m -52.10
	800.00M	707.56m-151.29	13.26 90.08	73.52m 25.73	479.20m -53.57
	900.00M	700.28m-156.92	12.32 86.27	75.04m 24.81	467.08m -54.95
	1.00G	695.53m-161.94	11.48 82.76	75.70m 24.17	458.39m -56.35
	1.20G	697.16m-170.42	9.97 75.52	77.07m 23.92	449.50m -59.38
	1.40G	703.24m-176.89	8.62 69.41	79.14m 23.97	445.32m -62.28
	1.60G	705.10m 178.26	7.62 64.27	80.32m 25.15	443.75m -64.63
	1.80G	699.85m 173.38	6.71 59.32	81.39m 26.31	437.97m -67.21
	2.00G	700.68m 168.22	5.77 55.06	82.85m 28.19	424.41m -70.31
	2.20G	716.45m 163.57	4.88 51.19	85.09m 29.31	409.60m -74.85
	2.40G	736.04m 160.34	4.09 46.51	85.92m 30.85	402.54m -80.92
	2.60G	746.71m 157.65	3.34 41.58	87.33m 33.24	409.43m -86.62
	2.80G	760.57m 153.90	2.71 38.09	91.64m 35.45	418.00m -90.73
	3.00G	758.37m 147.32	2.53 36.48	96.59m 35.67	410.80m -93.35

S-PARAMETERS

Input Power = -33.00dBm (continued)

Test Cond. (Volts/Amps)	Freq. (Hz)	S11 (Mag/angle)	S21 (dB/angle)	S12 (Mag/angle)	S22 (Mag/angle)
TYPICAL DEVICE (continued)					
10.00/19.99m	100.00M	658.72m -86.22	30.33 136.42	19.79m 55.21	753.13m -36.78
	200.00M	682.95m -125.63	26.76 115.59	26.70m 41.93	515.94m -51.84
	300.00M	694.86m -144.25	23.92 104.81	29.88m 38.34	394.63m -57.36
	400.00M	699.66m -154.80	21.69 97.88	32.38m 38.35	331.27m -59.99
	500.00M	701.35m -161.89	19.90 92.84	34.56m 39.59	296.30m -61.30
	600.00M	698.60m -167.21	18.38 88.86	36.72m 41.71	276.17m -61.93
	700.00M	696.56m -171.40	17.12 85.47	39.36m 42.82	265.69m -62.34
	800.00M	694.25m -175.13	15.99 82.55	42.01m 44.53	258.92m -62.54
	900.00M	693.34m -178.54	15.00 79.91	44.98m 45.75	255.03m -62.78
	1.00G	694.56m 178.36	14.12 77.41	47.52m 46.78	253.77m -63.19
	1.20G	701.53m 173.18	12.55 72.06	53.31m 49.05	254.68m -64.63
	1.40G	708.16m 169.16	11.16 67.15	59.42m 49.78	257.03m -66.29
	1.60G	703.58m 165.90	10.10 62.87	65.55m 51.45	262.19m -66.46
	1.80G	697.23m 162.03	9.19 58.58	71.58m 52.09	261.96m -67.55
	2.00G	700.27m 157.70	8.31 54.83	78.95m 53.10	253.62m -69.25
	2.20G	719.72m 154.17	7.46 51.67	84.30m 52.90	241.48m -73.41
	2.40G	739.95m 152.09	6.67 47.88	89.85m 52.94	236.51m -80.36
	2.60G	751.24m 150.56	5.92 43.74	94.65m 53.53	245.83m -87.18
2.80G	762.80m 146.96	5.34 40.06	102.22m 53.82	257.51m -90.89	
3.00G	756.21m 140.31	5.15 37.58	110.70m 52.08	254.67m -92.33	
10.00/29.99m	100.00M	633.84m -101.16	31.30 131.03	17.37m 51.60	688.15m -40.95
	200.00M	679.80m -136.92	27.21 111.21	22.47m 41.52	449.61m -54.13
	300.00M	695.90m -152.51	24.18 101.51	25.19m 40.13	341.95m -58.23
	400.00M	702.65m -161.25	21.89 95.30	27.66m 41.76	288.53m -59.84
	500.00M	704.91m -167.17	20.05 90.70	30.16m 44.20	260.86m -60.58
	600.00M	702.78m -171.73	18.52 86.99	32.69m 46.71	246.16m -60.74
	700.00M	701.24m -175.30	17.24 83.84	35.57m 48.21	239.44m -60.95
	800.00M	699.49m -178.59	16.11 81.13	38.61m 50.14	235.75m -61.03
	900.00M	699.63m 178.37	15.10 78.62	41.82m 51.18	234.05m -61.18
	1.00G	700.89m 175.56	14.22 76.26	44.78m 52.35	234.30m -61.53
	1.20G	708.20m 170.93	12.84 71.08	50.94m 53.95	238.13m -63.04
	1.40G	714.69m 167.27	11.25 66.37	57.52m 54.49	242.59m -64.54
	1.60G	709.78m 164.27	10.19 62.12	64.22m 55.59	249.88m -64.84
	1.80G	703.53m 160.52	9.28 57.80	70.37m 55.94	251.23m -65.88
	2.00G	707.80m 156.27	8.39 54.27	77.28m 56.80	243.83m -67.51
	2.20G	727.18m 152.96	7.54 51.00	83.78m 56.34	232.55m -71.74
	2.40G	747.72m 151.07	6.74 47.32	89.30m 56.10	228.47m -78.80
	2.60G	759.36m 149.54	6.00 43.18	94.60m 56.55	237.65m -85.95
2.80G	771.83m 146.03	5.40 39.61	102.35m 56.54	250.26m -89.69	
3.00G	766.02m 139.43	5.18 36.99	110.96m 54.64	247.92m -91.18	

S-PARAMETERS

SD1331

1330 S21(dB) vs. COLLECTOR CURRENT (mA) @3.0GHz

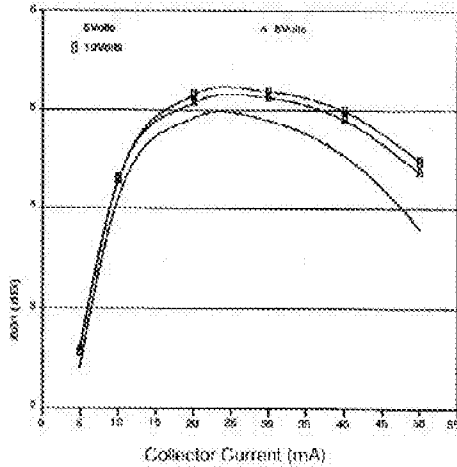

S885D1331-01

1330 FI vs. CURRENT AT F=1GHz

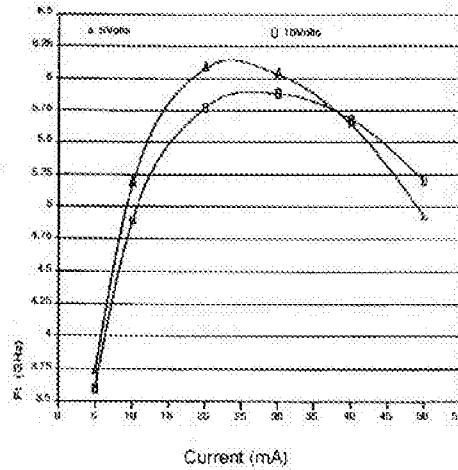

S885D1331-02

1330 Gmax vs. FREQUENCY

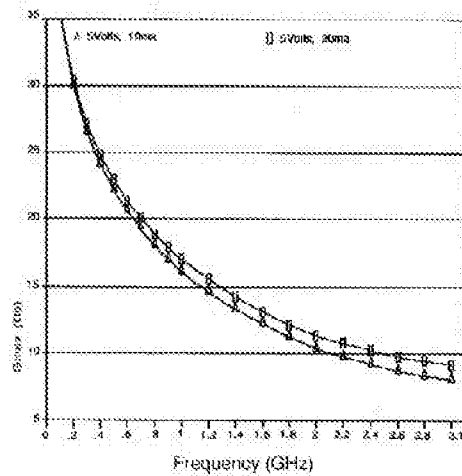

S885D1331-03

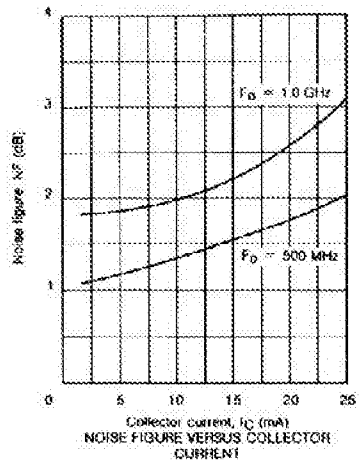

S08501331-04

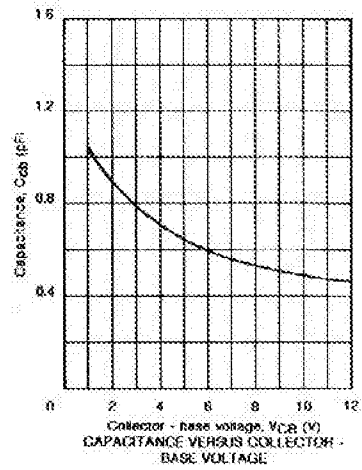

S08501331-05

SD1331

PACKAGE MECHANICAL DATA

.100 x .100 4L

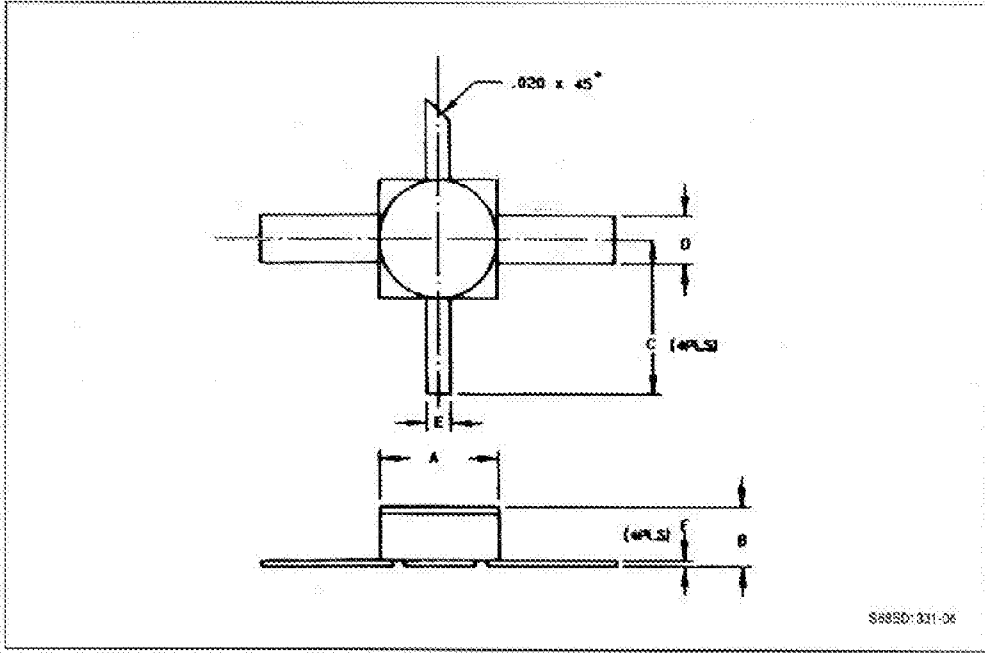

	Minimum Inches/mm	Maximum Inches/mm
A	.090/2.29	.105/2.67
B	.035/0.89	.055/1.40
C		.340/8.64
D	.035/0.89	.043/1.09
E	.016/0.41	.024/0.61
F	.003/0.06	.006/0.15