



**Features**

- -60dBc ACPR at 13dBm WCDMA
- 0.25W Output Power (P1dB)
- Excellent Linearity to DC Power Ratio
- High Gain: 17.5dB at 2.65GHz
- Single-Supply 5V Operation
- Class 2 (2000V) HBM ESD

**Applications**

- Driver Amplifier for Base Station Transceivers
- PA Stage for Commercial Wireless Infrastructure
- IF Amplifier
- GSM, DCS, PCS, UMTS, WiMAX, LTE Transceiver Applications

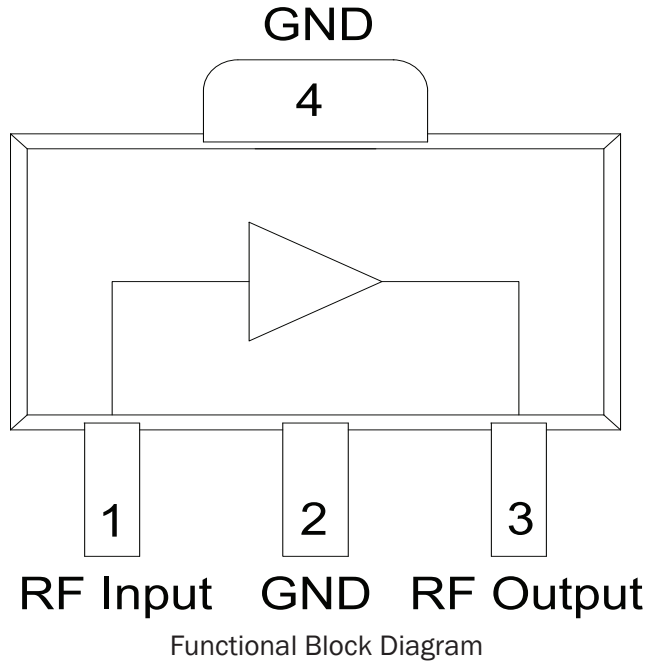

**Product Description**

The RFPA2089 is a single-stage InGaP HBT power amplifier specifically designed for wireless infrastructure applications. It offers high-gain linear operation at a comparably low DC power making it ideal for next generation radios requiring high efficiency. Its external matching allows for use across various radio platforms.

**Ordering Information**

RFPA2089SR	7" Reel with 100 pieces
RFPA2089SQ	Sample bag with 25 pieces
RFPA2089TR13	13" Reel with 2500 pieces
RFPA2089PCK-410	2.11GHz to 2.17GHz PCBA with 5-piece sample bag
RFPA2089PCK-411	2.6GHz to 2.7GHz PCBA with 5-piece sample bag
RFPA2089PCK-412	869MHz to 894MHz PCBA with 5-piece sample bag

**Optimum Technology Matching® Applied**

- |   |                                      |                                     |                                    |
|---|--------------------------------------|-------------------------------------|------------------------------------|
| <input type="checkbox"/> GaAs HBT             | <input type="checkbox"/> SiGe BiCMOS | <input type="checkbox"/> GaAs pHEMT | <input type="checkbox"/> GaN HEMT  |
| <input type="checkbox"/> GaAs MESFET          | <input type="checkbox"/> Si BiCMOS   | <input type="checkbox"/> Si CMOS    | <input type="checkbox"/> BiFET HBT |
| <input checked="" type="checkbox"/> InGaP HBT | <input type="checkbox"/> SiGe HBT    | <input type="checkbox"/> Si BJT     |                                    |

RF MICRO DEVICES®, RFMD®, Optimum Technology Matching®, Enabling Wireless Connectivity™, PowerStar®, POLARIS™ TOTAL RADIO™ and UltimateBlue™ are trademarks of RFMD, LLC. BLUETOOTH is a trademark owned by Bluetooth SIG, Inc., U.S.A. and licensed for use by RFMD. All other trade names, trademarks and registered trademarks are the property of their respective owners. ©2012, RF Micro Devices, Inc.

## Absolute Maximum Ratings

Parameter	Rating	Unit
Supply Voltage ( $V_D$ )	6.0	V
DC Supply Current ( $I_D$ )	185	mA
CW Input Power, 2:1 Output VSWR	20	dBm
Output Load VSWR at P3dB	5:1	
Operating Junction Temperature	150	°C
Operating Temperature Range ( $T_L$ )	-40 to +85	°C
Storage Temperature	-55 to +150	°C
ESD Rating - Human Body Model (HBM)	Class 2	
Moisture Sensitivity Level	MSL 2	

### Notes:

- The maximum ratings must all be met simultaneously.
- $P_{DISS} = P_{DC} + P_{RFIN} - P_{RFOUT}$
- $T_J = T_L + P_{DISS} * R_{TH}$



### Caution! ESD sensitive device.

Exceeding any one or a combination of the Absolute Maximum Rating conditions may cause permanent damage to the device. Extended application of Absolute Maximum Rating conditions to the device may reduce device reliability. Specified typical performance or functional operation of the device under Absolute Maximum Rating conditions is not implied.

The information in this publication is believed to be accurate and reliable. However, no responsibility is assumed by RF Micro Devices, Inc. ("RFMD") for its use, nor for any infringement of patents, or other rights of third parties, resulting from its use. No license is granted by implication or otherwise under any patent or patent rights of RFMD. RFMD reserves the right to change component circuitry, recommended application circuitry and specifications at any time without prior notice.



RFMD Green: RoHS compliant per EU Directive 2002/95/EC, halogen free per IEC 61249-2-21, < 1000ppm each of antimony trioxide in polymeric materials and red phosphorus as a flame retardant, and <2% antimony in solder.

Parameter	Specification			Unit	Condition
	Min.	Typ.	Max.		
<b>860MHz to 894MHz</b>					
Frequency	860	880	894	MHz	$V_{CC} = 5.0V, I_{CQ} = 138mA$ EVB tuned for optimum 60dBc ACPR
Input Power (Pin)			6	dBm	Max recommended continuous input power, $V_{CC} < 5.25V$ , Load VSWR < 2:1
Gain (S21)		23.2		dB	
P1dB		24		dBm	EVB tuned for linear operation
Input Return Loss (S11)		20		dB	
Output Return Loss (S22)		13		dB	
Noise Figure		5.9		dB	
WCDMA Channel Power at -60dBc ACPR		12		dBm	3GPP 3.5, Test Model 1, 64 DPCH
<b>UMTS 2100MHz</b>					
Frequency	2.11	2.14	2.17	GHz	$V_{CC} = 5.0V, I_{CQ} = 138mA$ EVB tuned for optimum 60dBc ACPR
Input Power (Pin)			11	dBm	Max recommended continuous input power, $V_{CC} < 5.25V$ , Load VSWR < 2:1
Gain (S21)		19.2		dB	
P1dB		24.7		dBm	EVB tuned for linear operation
Input Return Loss (S11)		17		dB	
Output Return Loss (S22)		12		dB	
Noise Figure		3.7		dB	
WCDMA Channel Power at -60dBc ACPR		13		dBm	3GPP 3.5, Test Model 1, 64 DPCH

Parameter	Specification			Unit	Condition
	Min.	Typ.	Max.		
<b>LTE Bands 7, 15, 16 (2.58GHz to 2.69GHz)</b>					$V_{CC} = 5.0V, I_{CQ} = 138mA$
Frequency	2.58	2.64	2.69	GHz	EVB tuned for optimum 60dBc ACPR
Input Power (Pin)			11	dBm	Max recommended continuous input power, $V_{CC} < 5.25V, \text{Load VSWR} < 2:1$
Gain (S21)		17.5		dB	
P1dB		24.7		dBm	EVB tuned for linear operation
Input Return Loss (S11)		20		dB	
Output Return Loss (S22)		9.5		dB	
Noise Figure		3.9		dB	
WCDMA Channel Power at -60dBc ACPR		13.3		dBm	3GPP 3.5, Test Model 1, 64 DPCH
<b>Power Supply</b>					
Operating Current (Quiescent)		138		mA	At $V_S = 5.0V$ with dropping $R = 3.9\Omega$
Operating Voltage ( $V_{CC}$ )		5.0	5.25	V	Max recommended collector voltage for continuous operation
Thermal Resistance ( $R_{TH}$ )		52		C/W	Junction to Pin 4

## Typical Performance – 860MHz to 894MHz Application Circuit

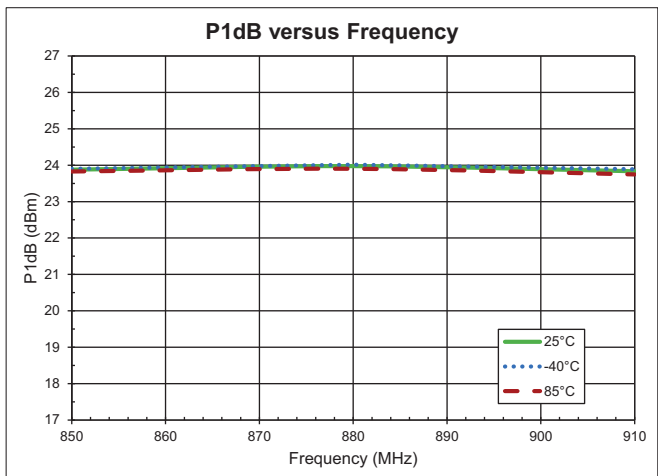
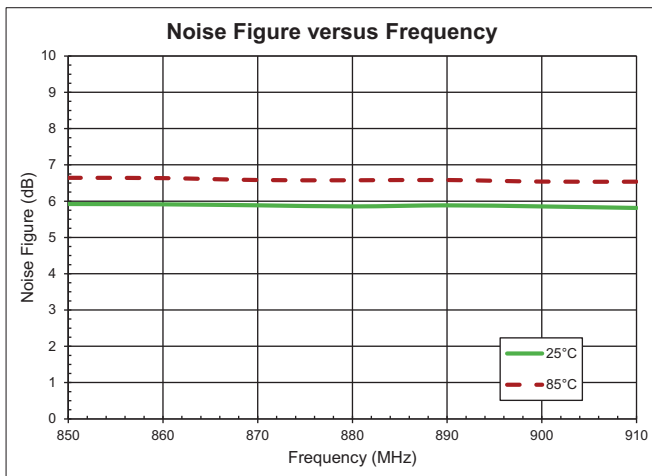
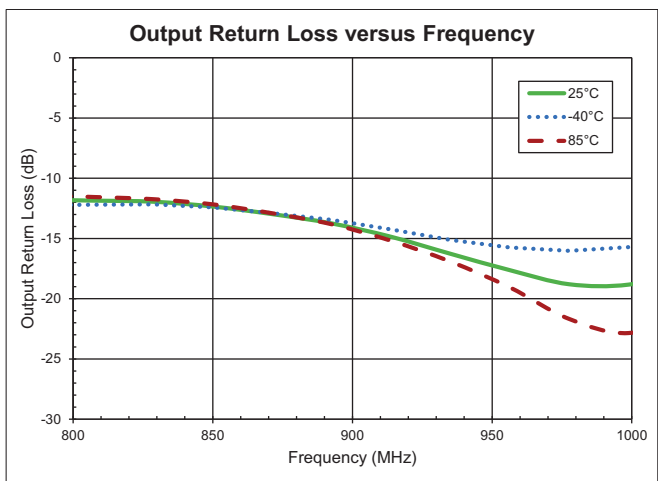
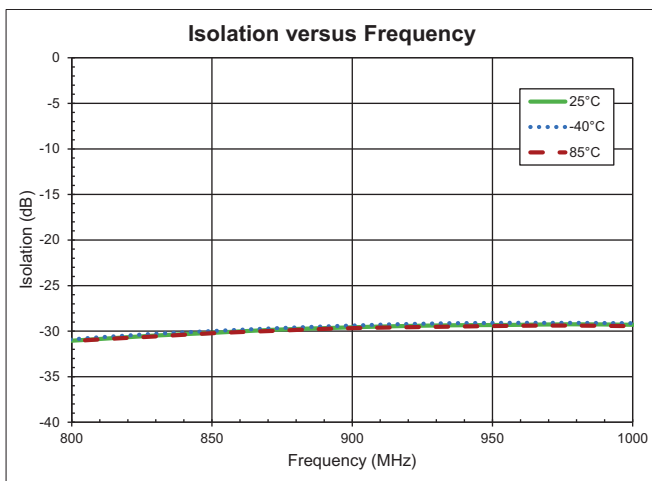
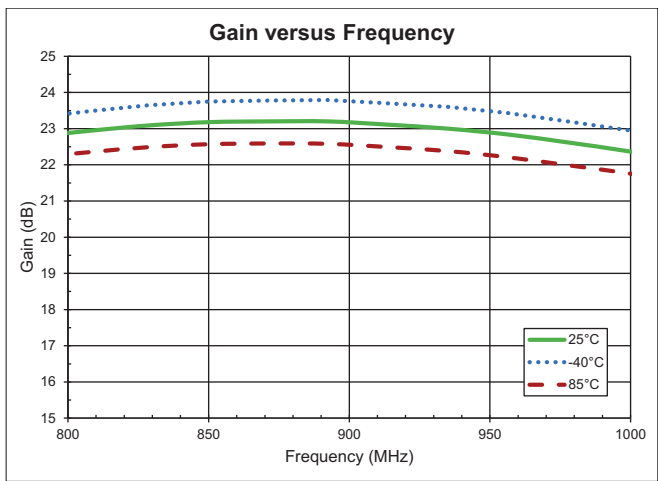
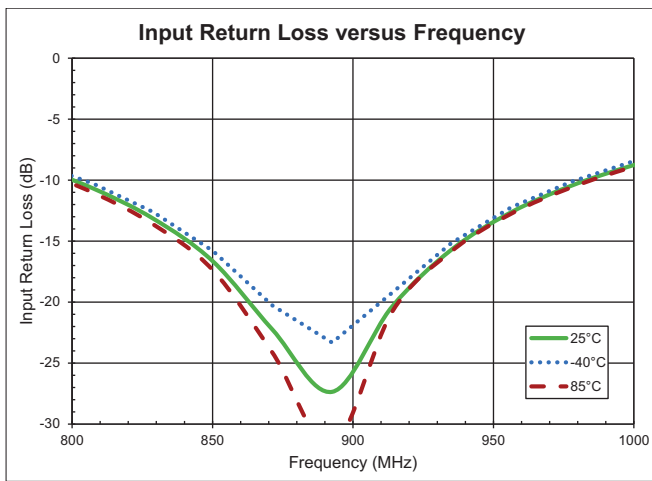

**Typical Performance – 860MHz to 894MHz Application Circuit**

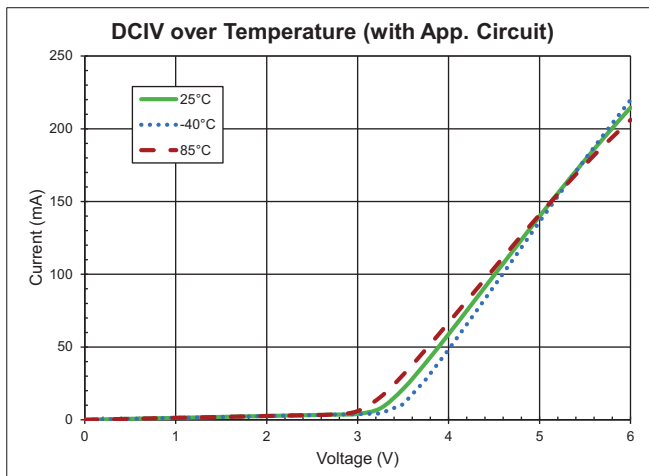
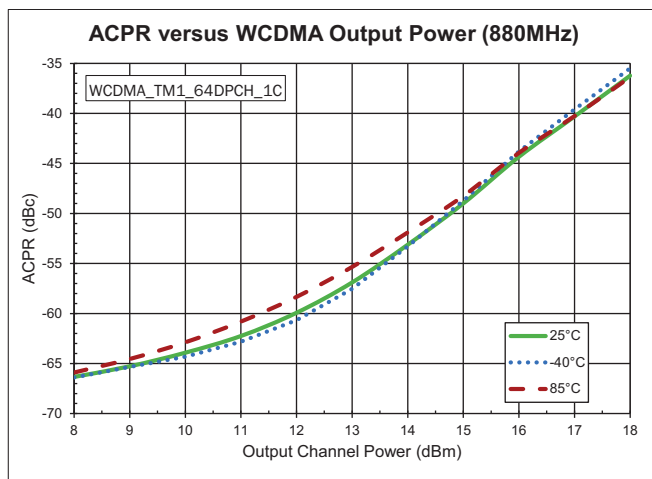
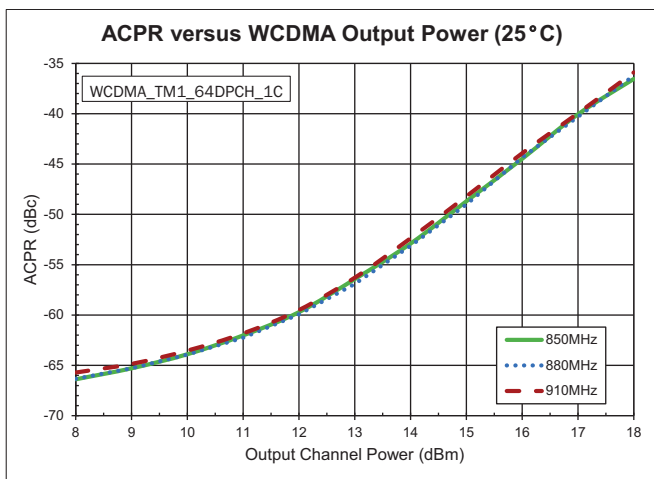
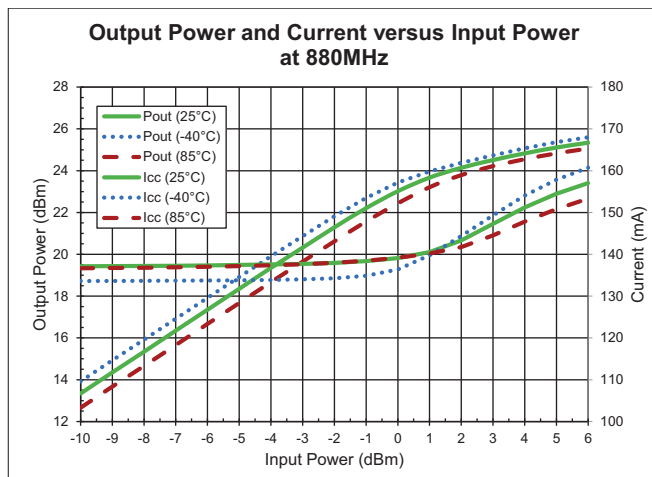
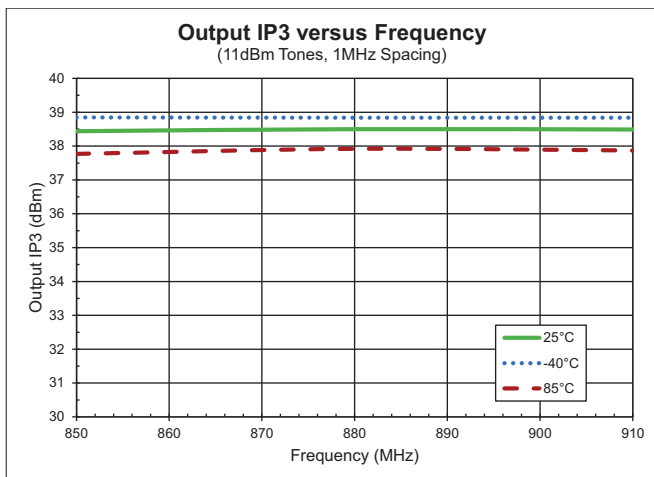

## Evaluation Board Schematic 860MHz to 894MHz Application Circuit

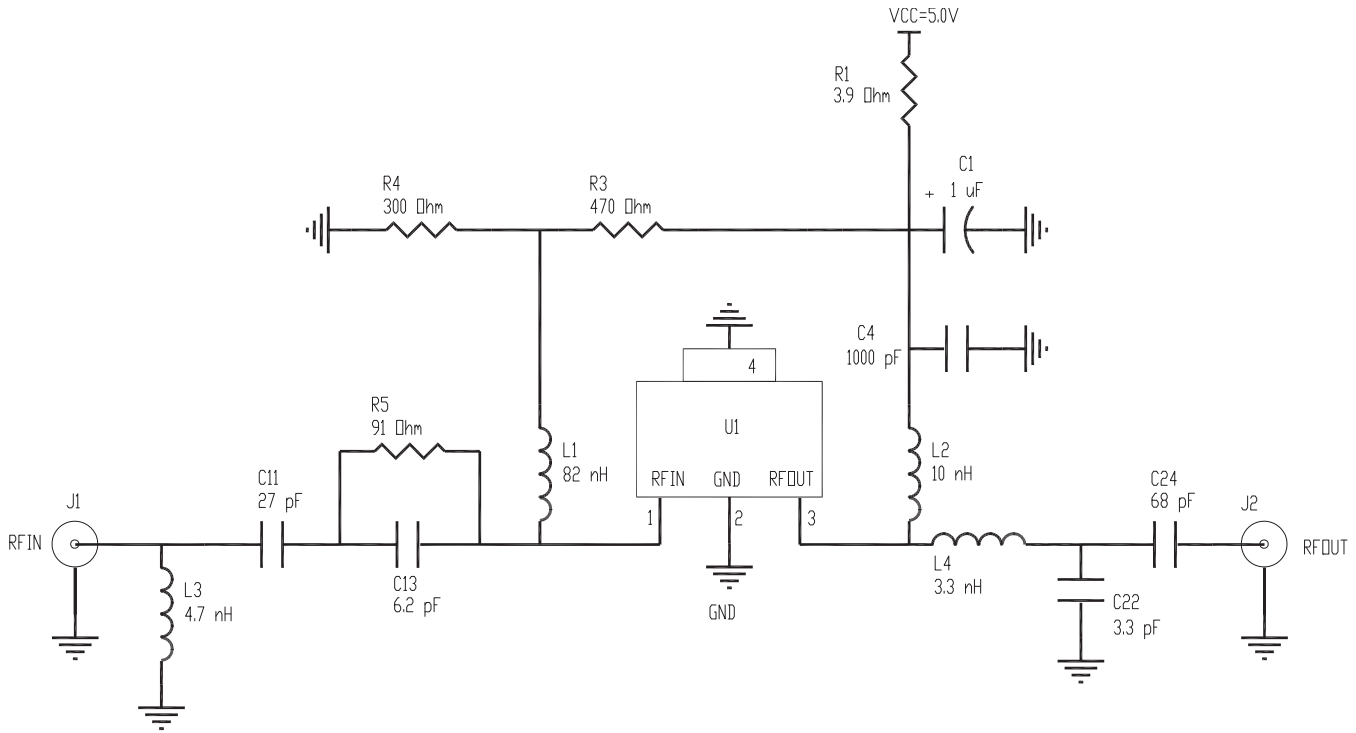

## Evaluation Board Bill of Materials (BOM) 860MHz to 894MHz Application Circuit

Description	Reference Designator	Manufacturer	Manufacturer's P/N
Evaluation Board			PA2089-411(A)
0.25W Linear PA in SOT89	U1	RFMD	PA2089
CAP, 1μF, 20%, 20V, TANT-A	C1	AVX Corporation	TAJA105M020R
CAP, 1000pF, 10%, 50V, X7R, 0402	C4	Taiyo Yuden (USA), Inc.	RM UMK105BJ102KV-F
CAP, 27pF, 5%, 50V, CG, 0402	C11	Taiyo Yuden (USA), Inc.	RM UMK105CG270JV-F
CAP, 6.2pF, +/-0.5pF, 50V, C0G, 0402	C13	Taiyo Yuden (USA), Inc.	RM UMK105CG6R2DW
CAP, 3.3pF, +/-0.25pF, 50V, C0G, 0402	C22	Taiyo Yuden (USA), Inc.	RM UMK105CG3R3CW
CAP, 68pF, 5%, 50V, CG, 0402	C24	Taiyo Yuden (USA), Inc.	RM UMK105CG680JV-F
CONN, SMA, END LNCH, MINI, FLT, 0.068"	J1-J2	Emerson Networks	142-0741-851
IND, 82nH, 5%, M/L, 0603	L1	Toko	LL1608-FSL82NJ
IND, 10nH, 5%, M/L, 0603	L2	Toko	LL1608-FSL10NJ
IND, 4.7nH, +/-0.3nH, M/L, 0402	L3	TOKO INC.	LL1005-FH4N7S
IND, 3.3nH, +/-0.3nH, M/L, 0402	L4	TOKO INC.	LL1005-FHL3N3S
RES, 3.9Ω, 5%, 1/10W, 0603	R1	Panasonic	ERJ-3GEYJ3R9V
RES, 470Ω, 5%, 1/16W, 0402	R3	Kamaya, Inc	RMC1/16S-471JTH
RES, 300Ω, 5%, 1/16W, 0402	R4	Panasonic	ERJ-2GEJ301
RES, 91Ω, 5%, 1/16W, 0402	R5	Kamaya, Inc	RMC1/16S-910JTH
Do Not Place (DNP)	C2-C3, C5-C10, C12, C14-C21, C23, R2		

**Evaluation Board Assembly Drawing**  
860MHz to 894MHz Application Circuit

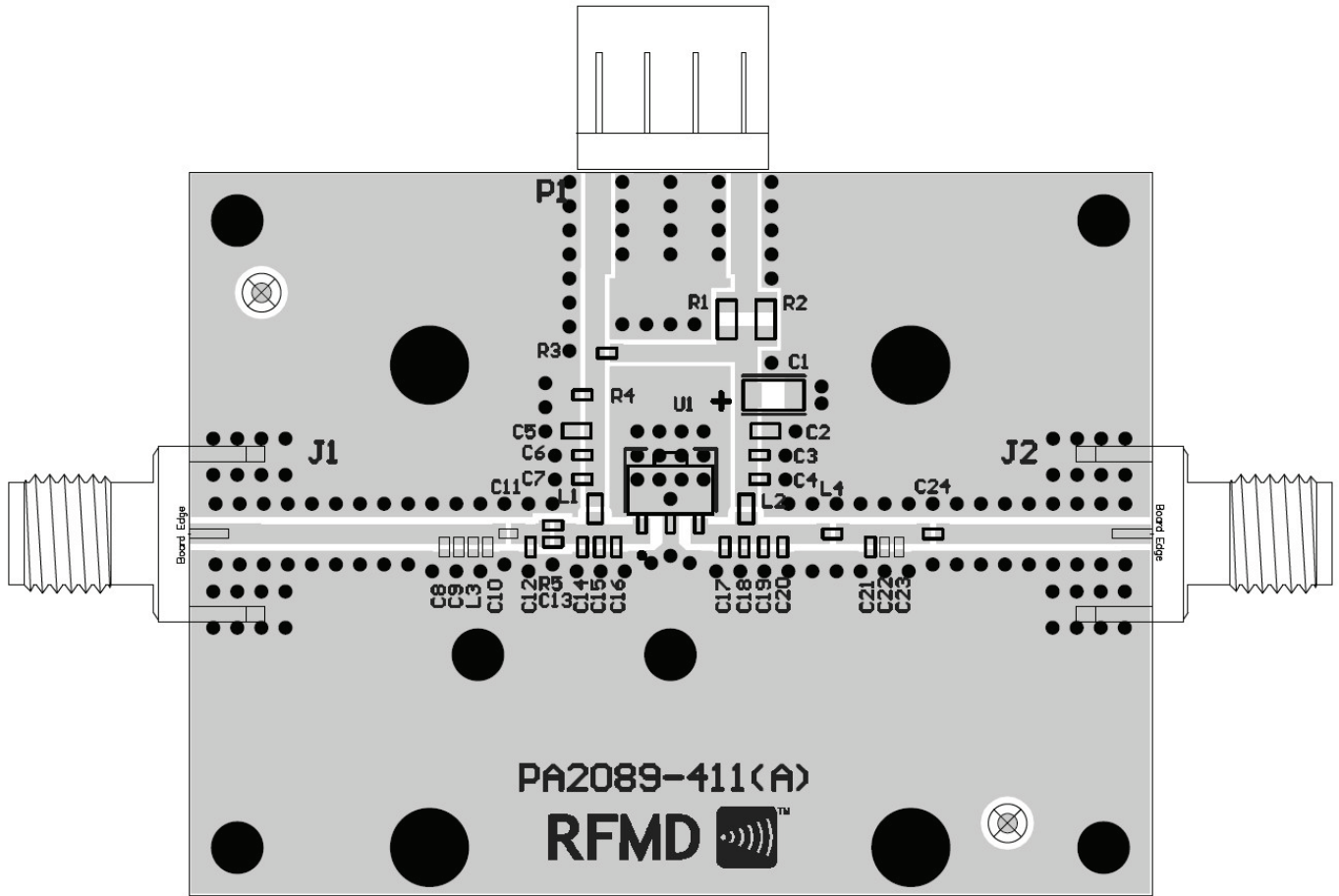

## Typical Performance – 2.11GHz to 2.17GHz Application Circuit

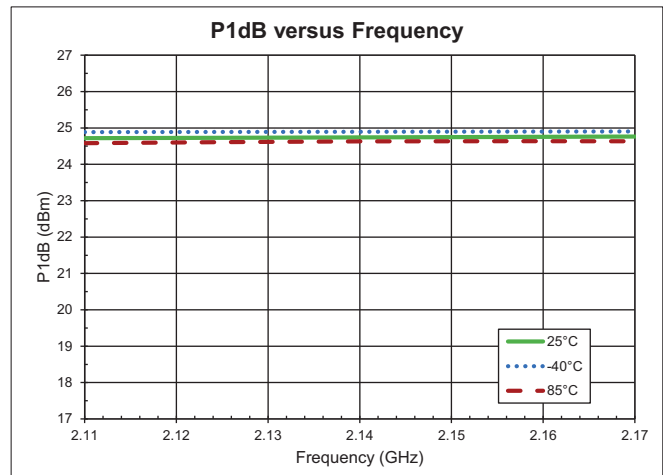
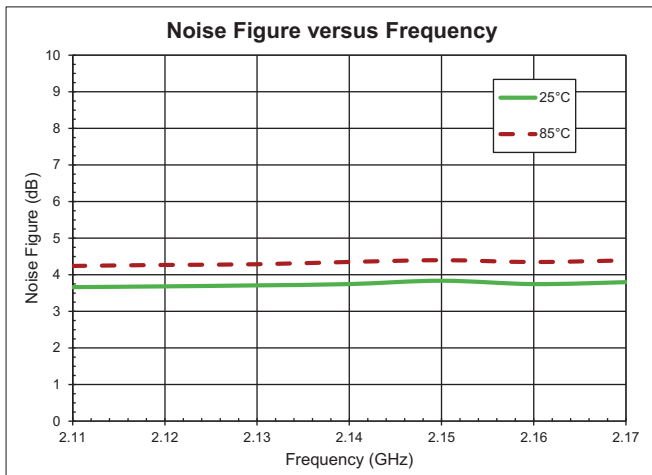
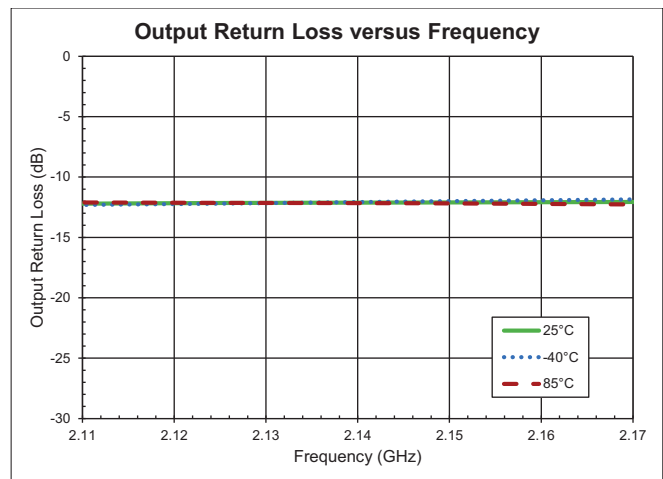
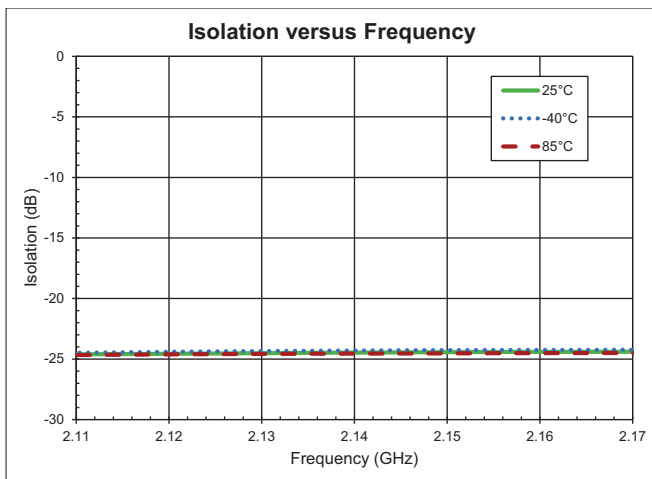
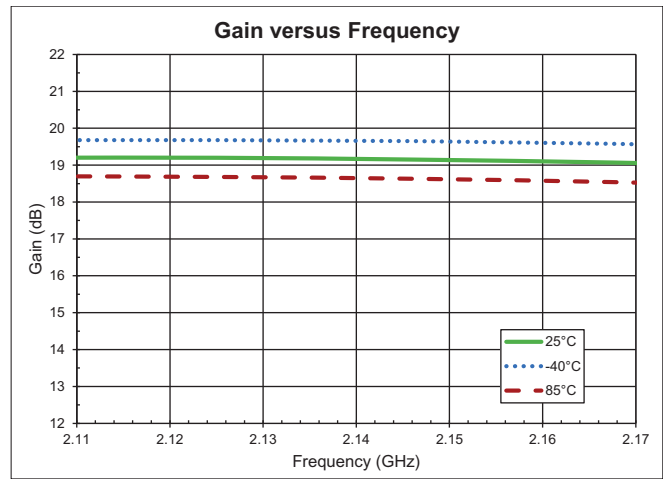
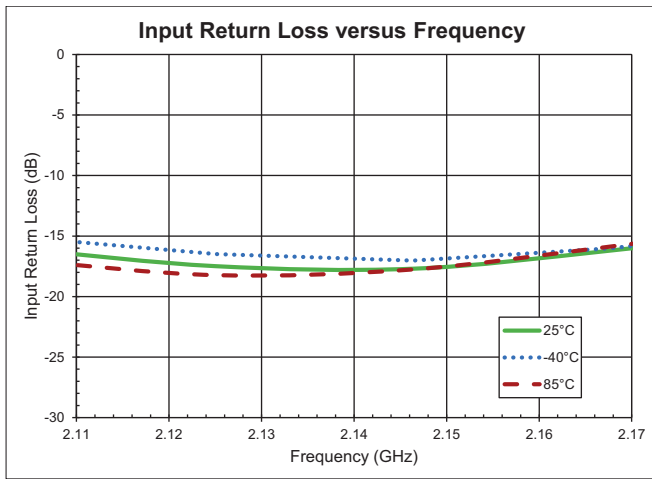



**Typical Performance – 2.11GHz to 2.17GHz Application Circuit**

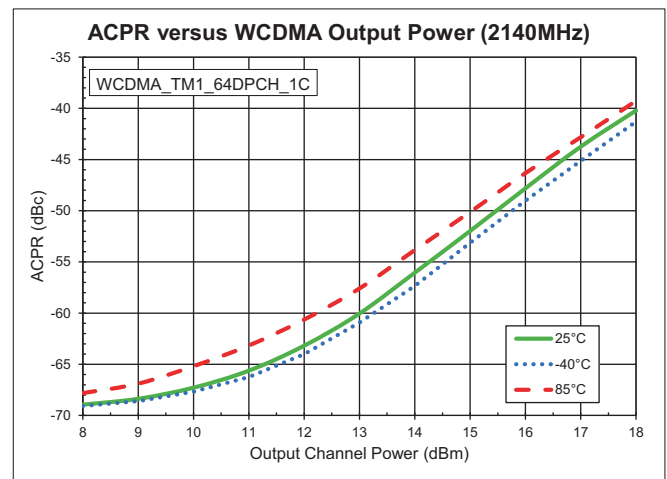
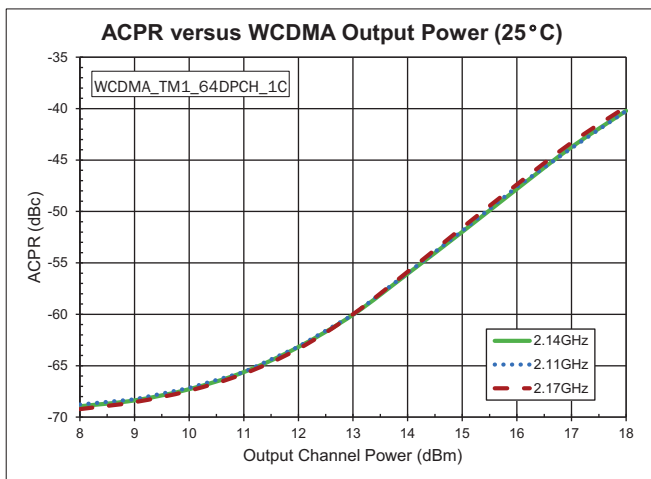
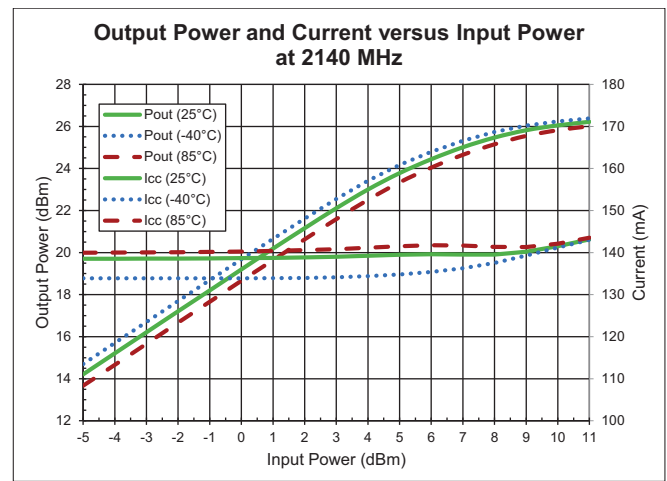
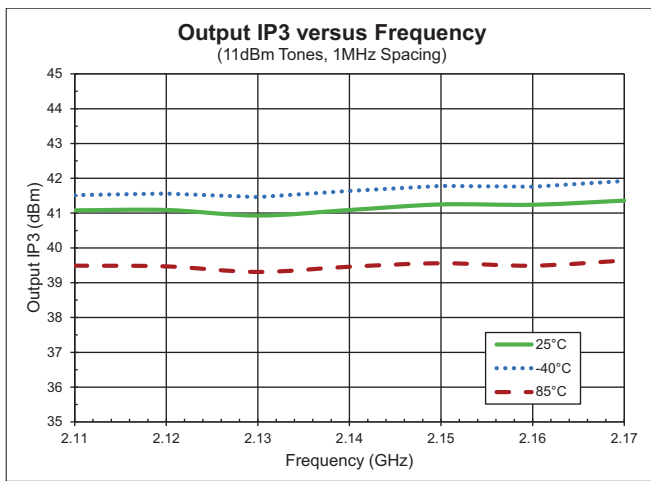

## Evaluation Board Schematic 2.11GHz to 2.17GHz Application Circuit

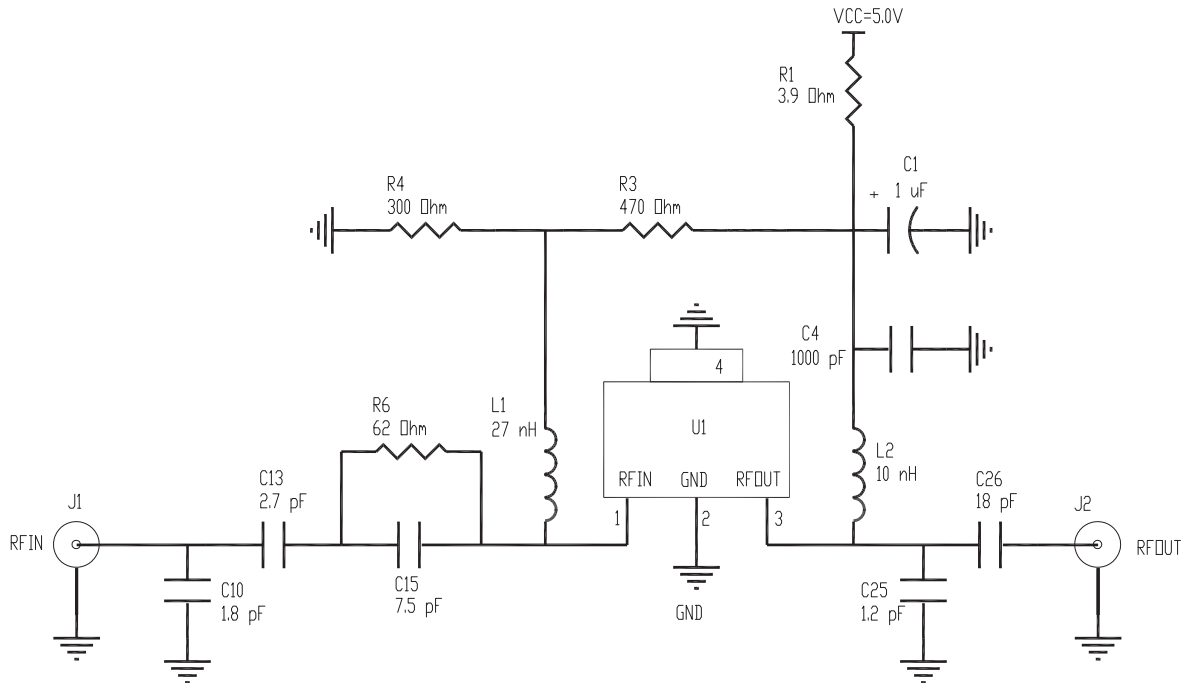

## Evaluation Board Bill of Materials (BOM) 2.11GHz to 2.17GHz Application Circuit

Description	Reference Designator	Manufacturer	Manufacturer's P/N
Evaluation Board			PA2089-410(A)
0.25W Linear PA in SOT89	U1	RFMD	PA2089
CAP, 1μF, 20%, 20V, TANT-A	C1	AVX Corporation	TAJA105M020R
CAP, 1000pF, 10%, 50V, X7R, 0402	C4	Taiyo Yuden (USA), Inc.	RM UMK105BJ102KV-F
CAP, 1.8pF, +/-0.25pF, 50V, COG, 0402	C10	Taiyo Yuden (USA), Inc.	RM UMK105CG1R8CW
CAP, 2.7pF, +/-0.25pF, 50V, COG, 0402	C13	Taiyo Yuden (USA), Inc.	RM UMK105CG2R7CW
CAP, 7.5pF, +/-0.1pF, 50V, COG, 0402	C15	Murata Electronics	GRM1555C1H7R5BZ01E
CAP, 1.2pF, +/-0.25pF, 50V, COG, 0402	C25	Taiyo Yuden (USA), Inc.	RM UMK105CG1R2CW
CAP, 18pF, 5%, 50V, CG, 0402	C26	Taiyo Yuden (USA), Inc.	RM UMK105 CG180JV-F
CONN, SMA, END LNCH, MINI, FLT, 0.068"	J1- J2	Emerson Network Power	142-0741-851
IND, 27nH, 5%, M/L, 0603	L1	TOKO INC.	LL1608-FSL27NJ
IND, 10nH, 5%, M/L, 0603	L2	TOKO INC.	LL1608-FSL10NJ
RES, 3.9Ω, 5%, 1/10W, 0603	R1	Panasonic	ERJ-3GEYJ3R9V
RES, 470Ω, 5%, 1/16W, 0402	R3	Kamaya, Inc	RMC1/16S-471JTH
RES, 300Ω, 5%, 1/16W, 0402	R4	Panasonic	ERJ-2GEJ301
RES, 62Ω, 1%, 1/16W, 0402	R6	Rohm Electronics	MCR01MZPF62R0
Do Not Place (DNP)	C2-C3, C5-C9, C11-C12, C14, C16-C24, C27, R2, R5		

**Evaluation Board Assembly Drawing**  
2.11GHz to 2.17GHz Application Circuit

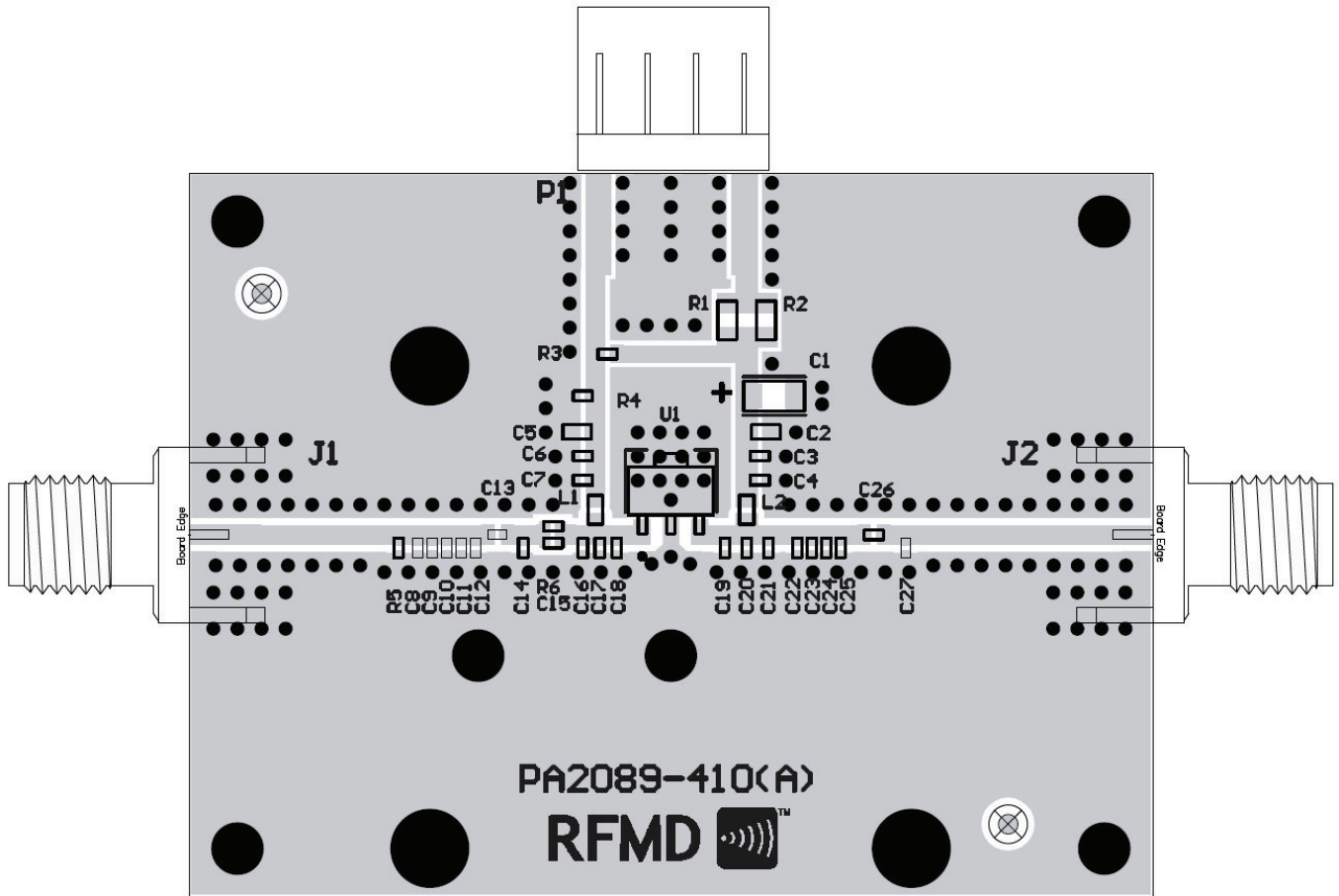

## Typical Performance – 2.58GHz to 2.69GHz Application Circuit

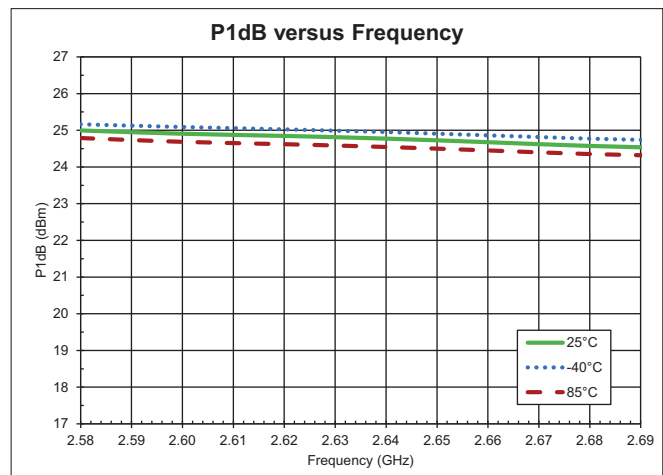
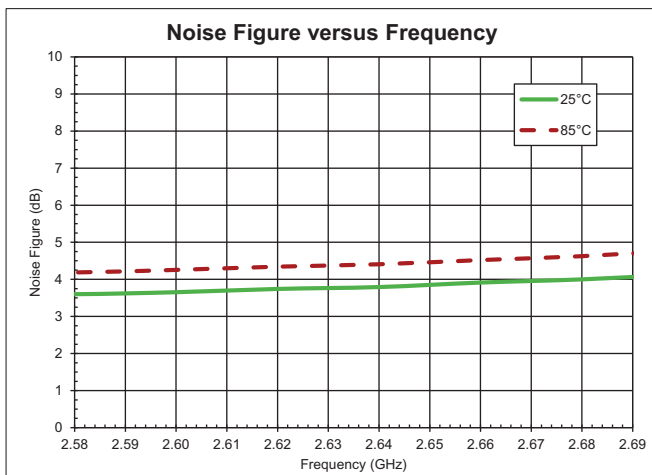
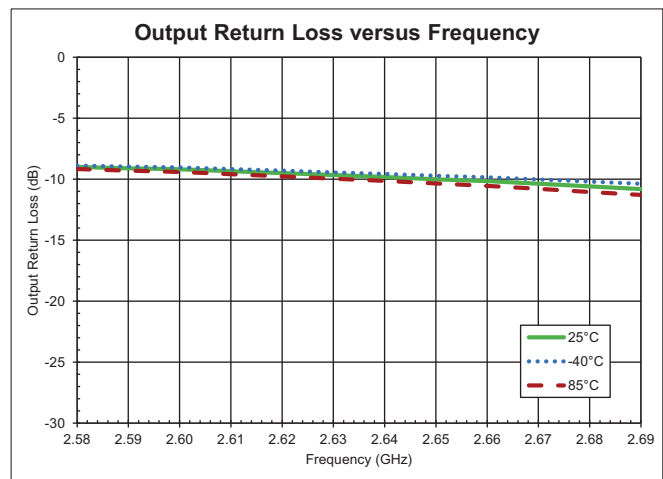
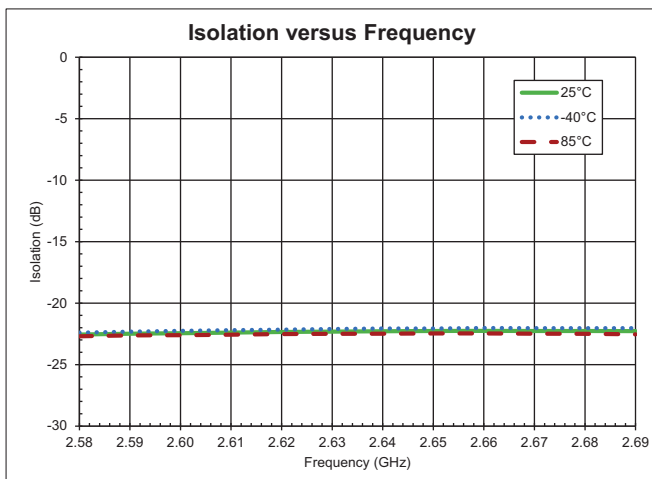
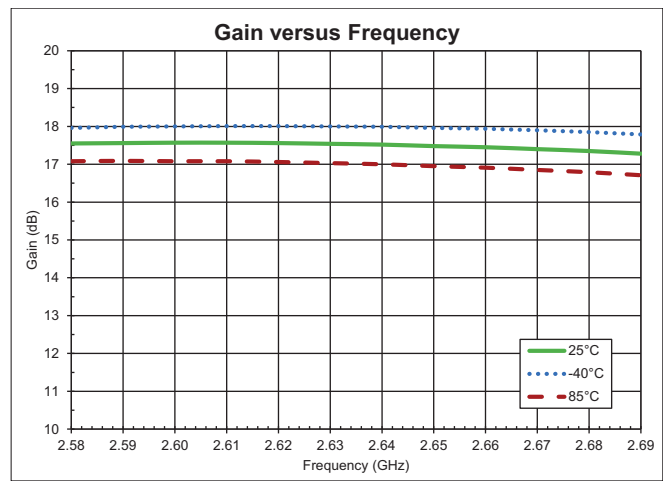
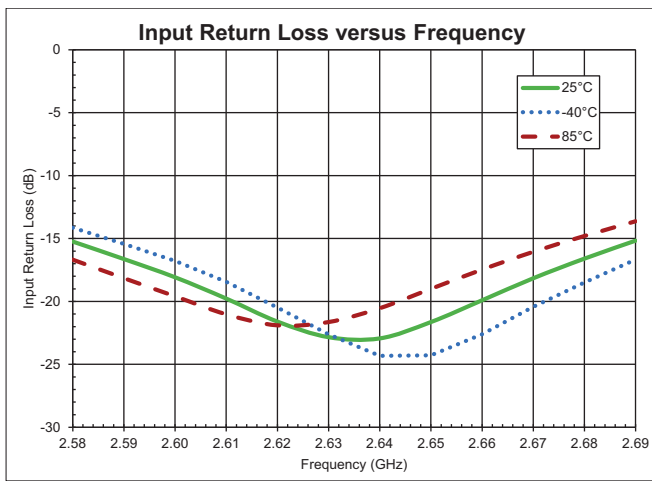

**Typical Performance – 2.58GHz to 2.69GHz Application Circuit**

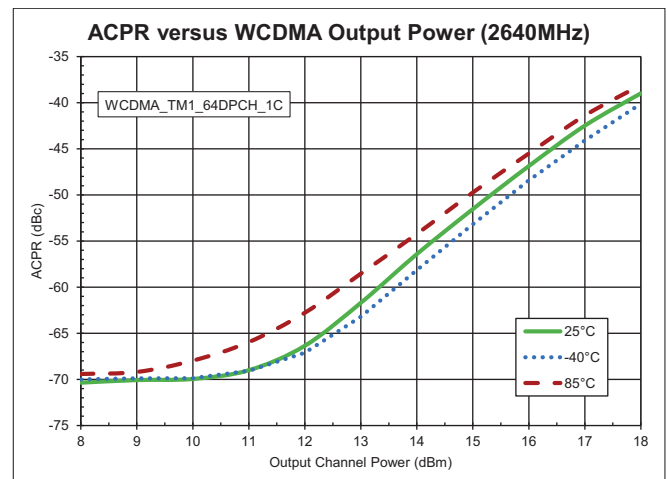
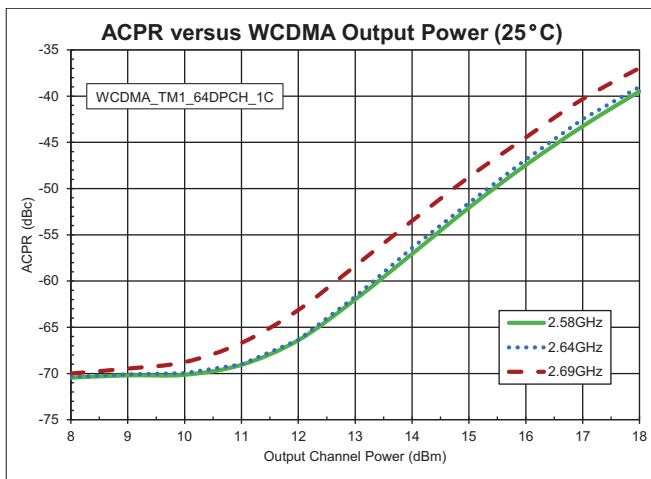
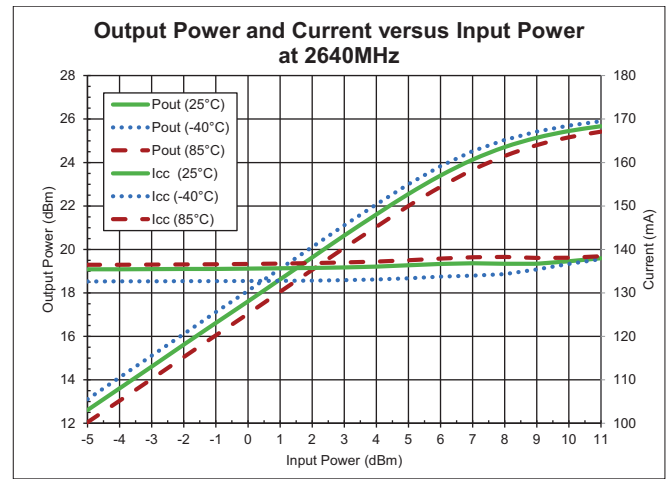
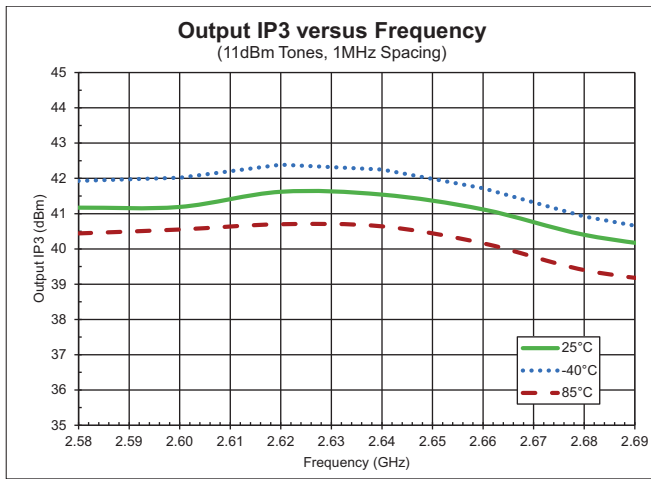

## Evaluation Board Schematic 2.58GHz to 2.69GHz Application Circuit

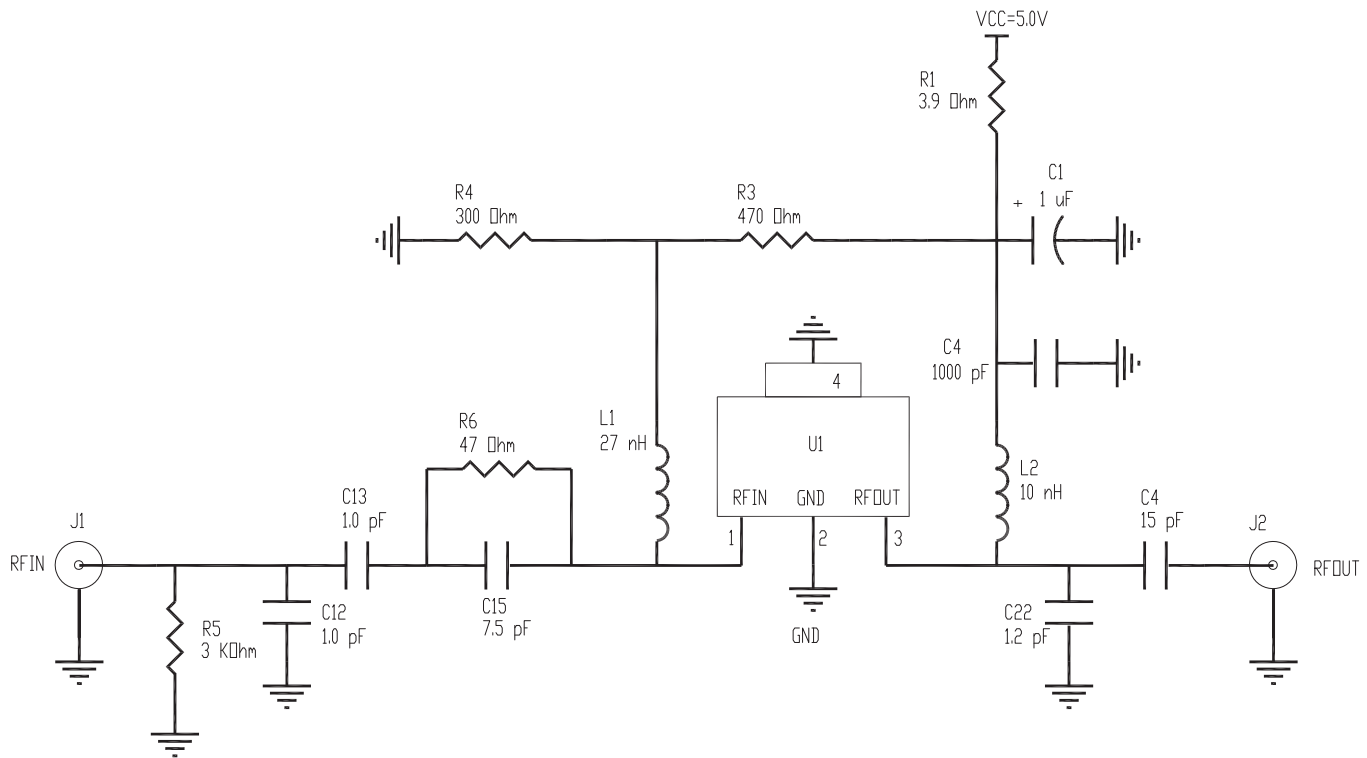

## Evaluation Board Bill of Materials (BOM) 2.58GHz to 2.69GHz Application Circuit

Description	Reference Designator	Manufacturer	Manufacturer's P/N
Evaluation Board			PA2089-410(A)
0.25W Linear PA in SOT89	U1	RFMD	PA2089
CAP, 1μF, 20%, 20V, TANT-A	C1	AVX Corporation	TAJA105M020R
CAP, 1000pF, 10%, 50V, X7R, 0402	C4	Taiyo Yuden (USA), Inc.	RM UMK105BJ102KV-F
CAP, 1pF, +/-0.25pF, 50V, CG, 0402	C12, C13	Taiyo Yuden (USA), Inc.	RM UMK105CG010CW-F
CAP, 7.5pF, +/-0.1pF, 50V, COG, 0402	C15	Murata Electronics	GRM1555C1H7R5BZ01E
CAP, 1.2pF, +/-0.25pF, 50V, COG, 0402	C22	Taiyo Yuden (USA), Inc.	RM UMK105CG1R2CW
CAP, 15pF, 5%, 50V, CG, 0402	C26	Taiyo Yuden (USA), Inc.	RM UMK105 CG150JV-F
CONN, SMA, END LNCH, MINI, FLT, 0.068"	J1-J2	Emerson Network Power	142-0741-851
IND, 27nH, 5%, M/L, 0603	L1	Toko	LL1608-FSL27NJ
IND, 10nH, 5%, M/L, 0603	L2	Toko	LL1608-FSL10NJ
RES, 3.9Ω, 5%, 1/10W, 0603	R1	Panasonic	ERJ-3GEYJ3R9V
RES, 470Ω, 5%, 1/16W, 0402	R3	Kamaya, Inc	RMC1/16S-471JTH
RES, 300Ω, 5%, 1/16W, 0402	R4	Panasonic	ERJ-2GEJ301
RES, 3K, 5%, 1/16W, 0402	R5	Kamaya, Inc	RMC1/16S-302JTH
RES, 47Ω, 5%, 1/16W, 0402	R6	Kamaya, Inc	RMC1/16S-470JTH
Do Not Place (DNP)	C2-C3, C5-C11, C14, C16-C21, C23-C25, C27, R2		

**Evaluation Board Assembly Drawing**  
2.58GHz to 2.69GHz Application Circuit

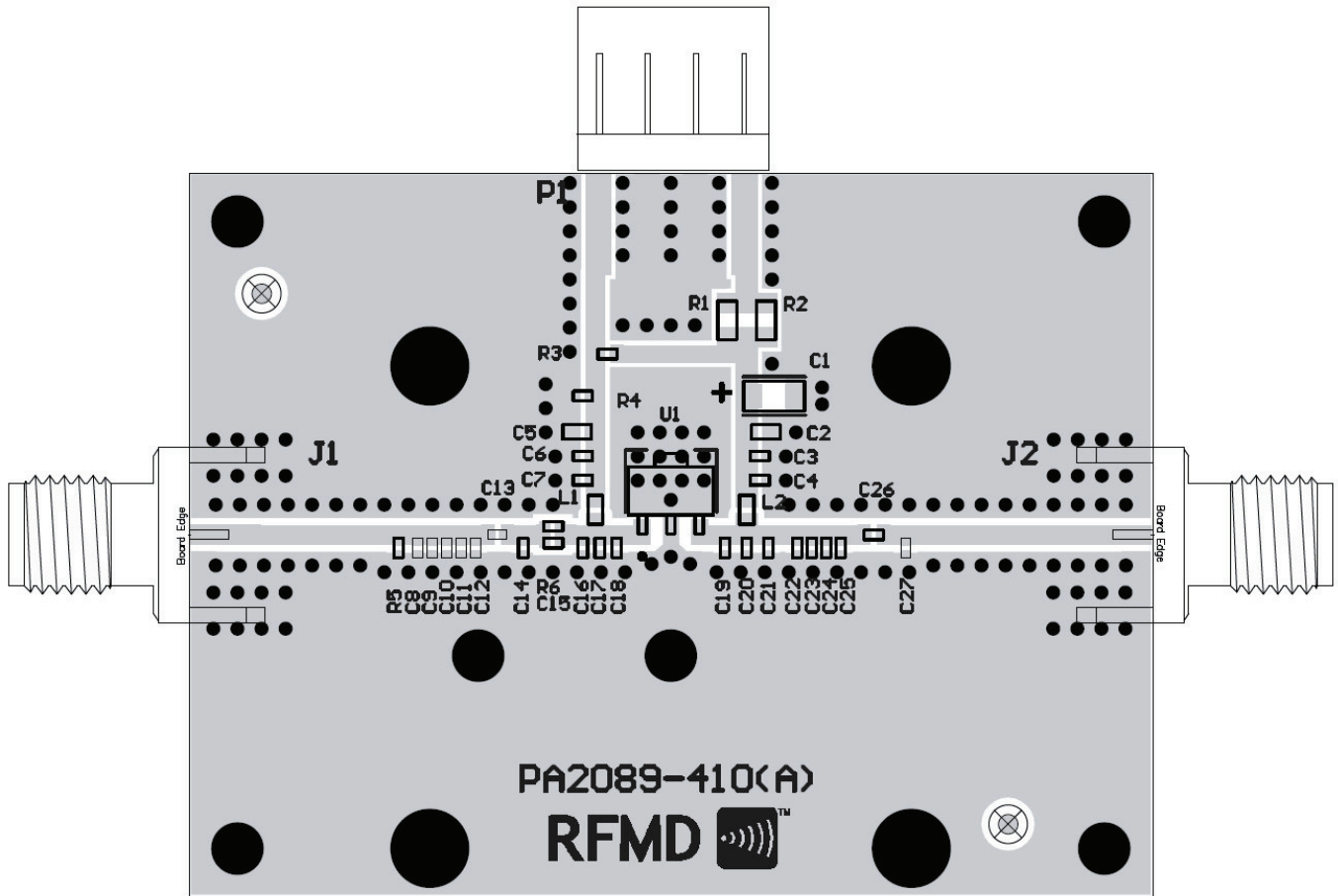

**Pin Names and Descriptions**

Pin	Name	Description
1	RF IN	RF Input. External DC Block is Required.
2	GND	DC and RF Ground
3	RF OUT/VCC	RF Output, Device Collector
4	GND	DC and RF Ground. Must be soldered to EVB ground plane over a bed of vias for thermal and RF performance.

## Branding Diagram

Trace Code to be assigned by the assembly SubCon.

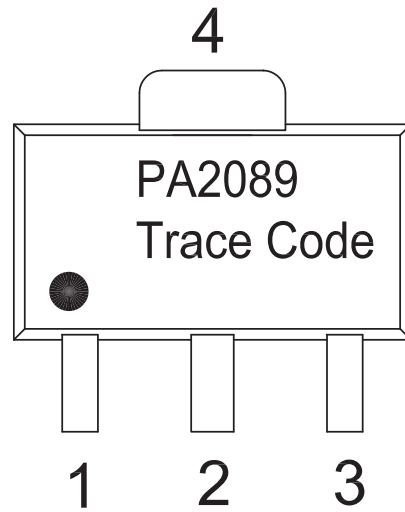

## Package Drawing

Dimensions in inches [millimeters]

Refer to drawing posted at [www.rfmd.com](http://www.rfmd.com) for tolerances.

