



SURFACE MOUNT SCHOTTKY DIODE ARRAYS

These devices feature electrically-isolated Schottky diodes connected in various configurations housed in a very small SOT-363 (SC70-6L)

FEATURES

- Maximum forward voltage @ 10mA of 0.5V
- Maximum leakage current @ 25V of 1.0uA
- Reverse voltage rating of 40V
- In compliance with EU RoHS 2002/95/EC directives

APPLICATIONS

- Rail-to-rail ESD protection
- Overshoot and undershoot switching control
- Mobile phones and accessories
- Video game consoles connector ports

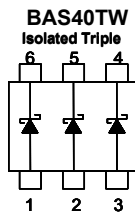
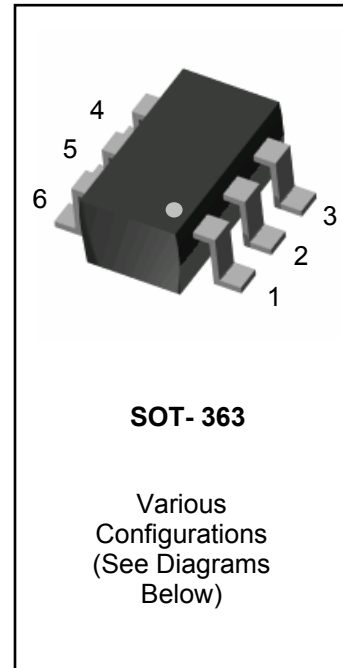

Marking Code: S40

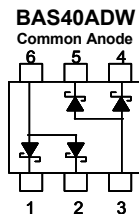

Marking Code: S42

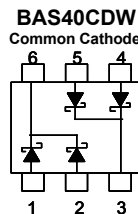

Marking Code: S43

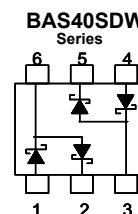

Marking Code: S44

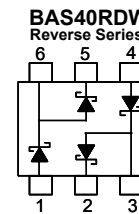

Marking Code: S45

MAXIMUM RATINGS (Per Diode) $T_J = 25^\circ\text{C}$ Unless otherwise noted

Rating	Symbol	Value	Units
Repetitive Peak Reverse Voltage	V_{RRM}	40	V
Continuous Reverse Voltage	V_R	40	V
Continuous Forward Current	I_F	200	mA
Non-repetitive Peak Forward Current, $t = 1\text{sec}$, Square Wave	I_{FSM}	600	mA
Total Power Dissipation (Note 1)	P_{tot}	225	mW
Operating Junction Temperature Range	T_J	-55 to 125	$^\circ\text{C}$
Storage Temperature Range	T_{stg}	-65 to 125	$^\circ\text{C}$

Note 1. FR-5 Board 1.0 x 0.75 x 0.062 in.

THERMAL CHARACTERISTICS

Characteristic	Symbol	Value	Units
Thermal Resistance, Junction to Ambient	$R_{\theta JA}$	556	$^\circ\text{C/W}$



ELECTRICAL CHARACTERISTICS (Per Diode) $T_j = 25^\circ\text{C}$ Unless otherwise noted

Parameter	Symbol	Conditions	Min	Typ	Max	Units
Breakdown Voltage (Note 1)	V_{BR}	$I_{BR} = 10\mu\text{A}$	40	-	-	V
Forward Voltage (Note 1)	V_F	$I_F = 1.0\text{mA}$	-	-	380	mV
		$I_F = 10\text{mA}$	-	-	500	
		$I_F = 40\text{mA}$	-	-	1000	
Reverse Leakage Current (Note 1)	I_R	$V_R = 25\text{V}$	-	-	1.0	μA
Total Capacitance	C_T	0Vdc Bias, $f = 1\text{MHz}$	-	-	5.0	pF
Reverse Recovery Time (See Figure 1)	t_{rr}	$I_F = 10\text{mA}$, $I_R = 10\text{mA}$ $R_L = 100\text{ Ohms}$; measured at $I_{R\text{rec}} = 1\text{mA}$	-	-	5.0	ns

Note 1. Short duration pulse to minimize self-heating effect

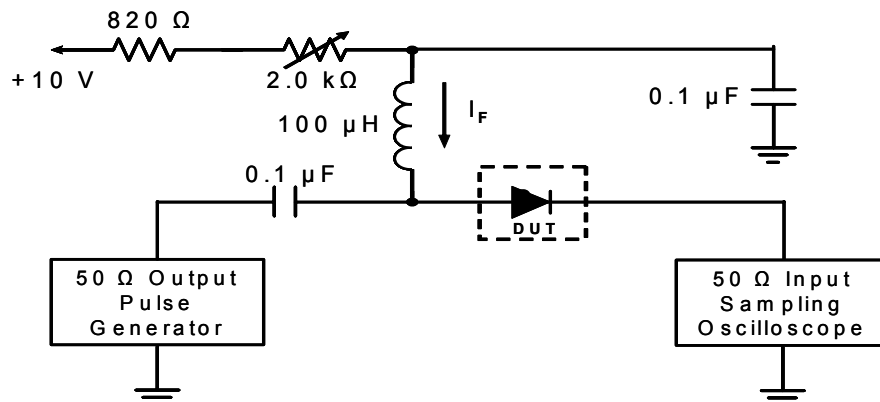

- Notes: 1. A 2.0k Ω variable resistor adjusted for a forward current (I_F) to 10mA
2. Input pulse is adjusted to $I_{R(\text{peak})}$ is equal to 10mA

Figure 1. REVERSE RECOVERY TIME EQUIVALENT TEST CIRCUIT



TYPICAL CHARACTERISTIC CURVES (Per Diode)

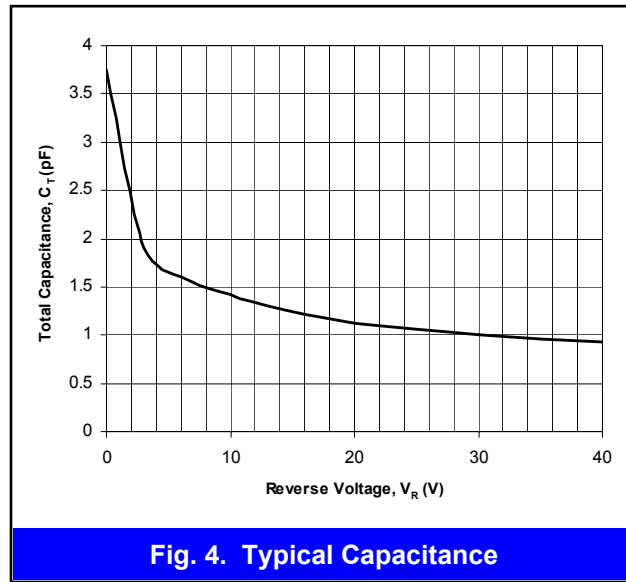
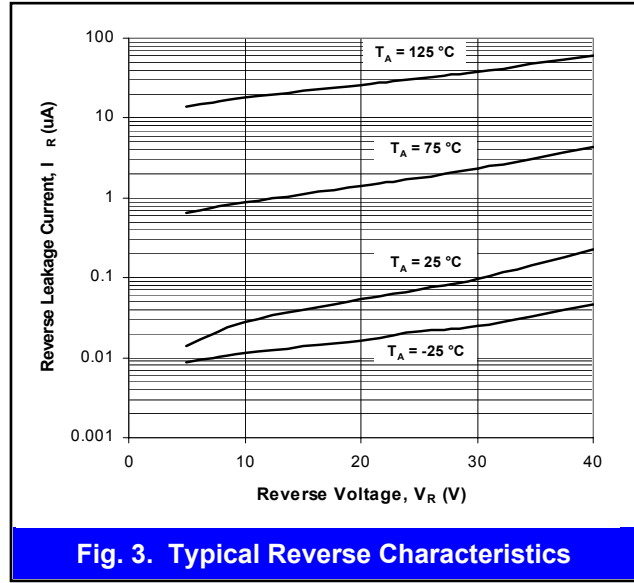
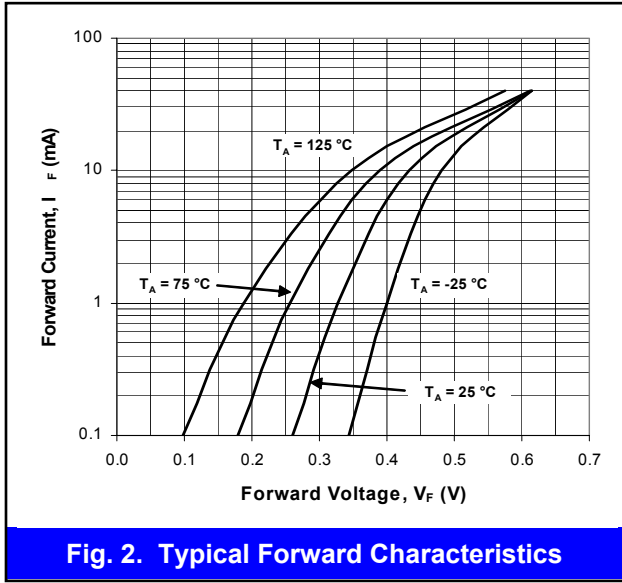



PACKAGE LAYOUT AND SUGGESTED PAD DIMENSIONS

SOT-363 Unit : inch(mm)

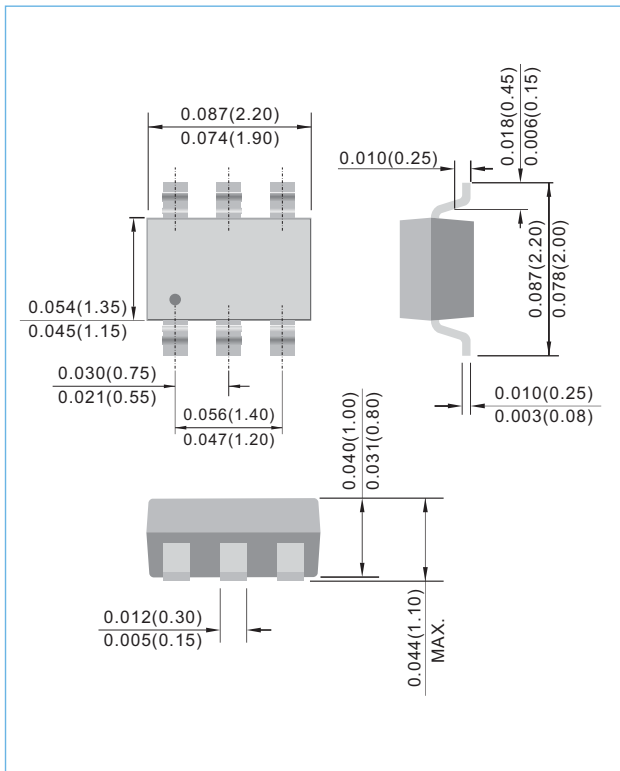

SOT-363 Unit : inch(mm)

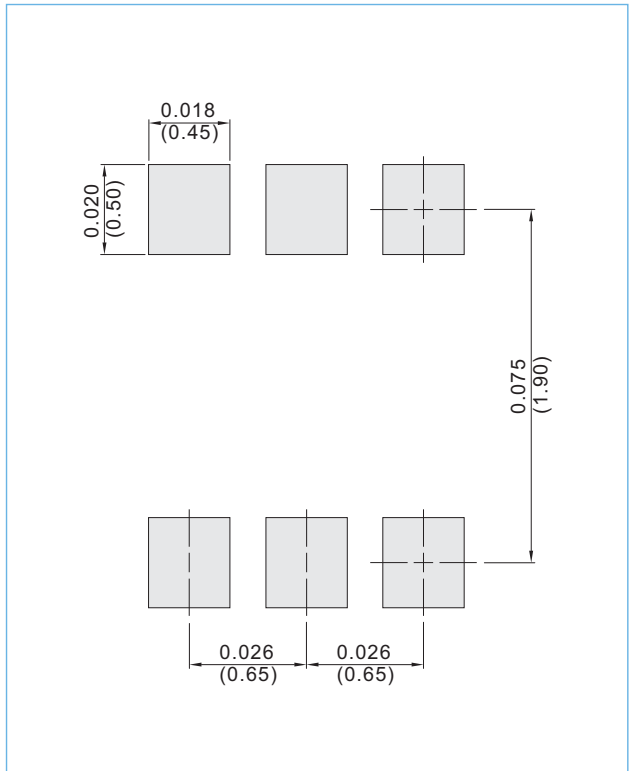

ORDERING INFORMATION

BAS40xxx T/R7 - 7" reel, 3K units per reel

BAS40xxx T/R13 - 13" reel, 10K units per reel

Copyright PanJit International, Inc 2011

The information presented in this document is believed to be accurate and reliable. The specifications and information herein are subject to change without notice. Pan Jit makes no warranty, representation or guarantee regarding the suitability of its products for any particular purpose. Pan Jit products are not authorized for use in life support devices or systems. Pan Jit does not convey any license under its patent rights or rights of others.