

16K x 4 Static RAM

L7C164/165/166

FEATURES

- 16K x 4 Static RAM with Common I/O
- Auto-Powerdown™ Design
- Advanced CMOS Technology
- High Speed — to 8 ns maximum
- Low Power Operation
Active: 210 mW typical at 35 ns
Standby: 500 μW typical
- Data Retention at 2 V for Battery Backup Operation
- Plug Compatible with IDT 7188/7198, Cypress CY7C164/166
- Package Styles Available:
 - 22/24-pin Plastic DIP
 - 22/24-pin Sidebrazed, Hermetic DIP
 - 22/24-pin CerDIP
 - 24-pin Plastic SOIC
 - 24-pin Plastic SOJ
 - 22-pin Ceramic LCC
 - 28-pin Ceramic LCC

DESCRIPTION

The L7C164, L7C165, and L7C166 are high-performance, low-power CMOS static RAMs. The storage cells are organized as 16,384 words by 4 bits per word. Data In and Data Out signals share I/O pins. The L7C164 has a single active-low Chip Enable. The L7C165 has two Chip Enables and a separate Output Enable. The L7C166 has a single Chip Enable and an Output Enable. These devices are available in seven speeds with maximum access times from 8 ns to 35 ns.

Inputs and output are TTL compatible. Operation is from a single +5 V power supply. Power consumption is 210 mW (typical) at 35 ns. Dissipation drops to 75 mW (typical) when the memory is deselected (Enable is high).

Two standby modes are available. Proprietary Auto-Powerdown™ circuitry reduces power consumption

automatically during read or write accesses which are longer than the minimum access time, or when the memory is deselected. In addition, data may be retained in inactive storage with a supply voltage as low as 2 V. The L7C164, L7C165, and L7C166 consume only 30 μW (typical) at 3 V, allowing effective battery backup operation.

The L7C164, L7C165, and L7C166 provide asynchronous (unclocked) operation with matching access and cycle times. An active-low Chip Enable and a three-state I/O bus simplify the connection of several chips for increased capacity.

Memory locations are specified on address pins A0 through A13. For the L7C164 and L7C166, reading from a designated location is accomplished by presenting an address and driving $\overline{CE}1$ low while \overline{WE} remains high. For the L7C165, both $\overline{CE}1$ and $\overline{CE}2$ must be low. The data in the addressed memory location will then appear on the Data Out pin within one access time. The output pin stays in a high-impedance state when \overline{CE} or \overline{OE} is high or \overline{WE} is low.

Writing to an addressed location is accomplished when the active-low \overline{CE} and \overline{WE} inputs are low. Either signal may be used to terminate the write operation. Data In and Data Out signals have the same polarity.

Latchup and static discharge protection are provided on-chip. The L7C164, L7C165, and L7C166 can withstand an injection current of up to 200 mA on any pin without damage.

2

L7C164/165/166 BLOCK DIAGRAM

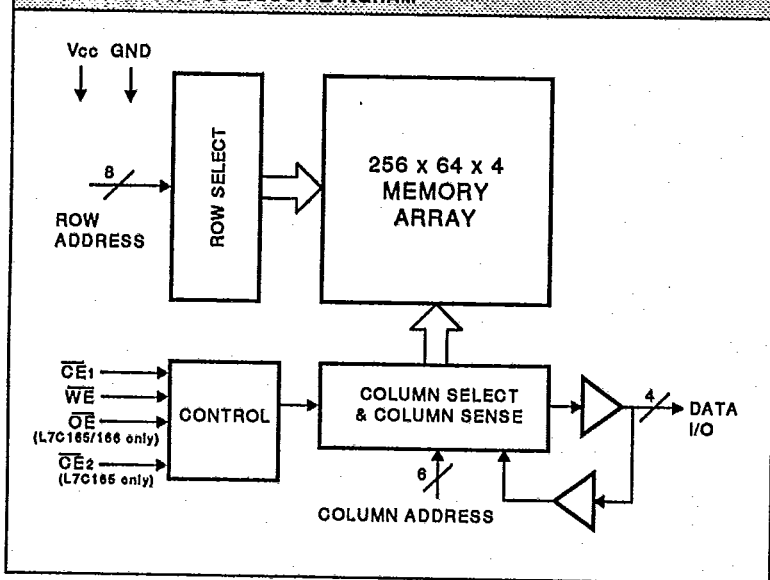

MAXIMUM RATINGS Above which useful life may be impaired (Notes 1, 2)	
Storage temperature	-65°C to +150°C
Operating ambient temperature	-55°C to +125°C
V _{CC} supply voltage with respect to ground	-0.5 V to +7.0 V
Input signal with respect to ground	-3.0 V to +7.0 V
Signal applied to high impedance output	-3.0 V to +7.0 V
Output current into low outputs	25 mA
Latchup current	> 200 mA

OPERATING CONDITIONS To meet specified electrical and switching characteristics		
Mode	Temperature Range (Ambient)	Supply Voltage
Active Operation, Commercial	0°C to +70°C	4.5 V ≤ V _{CC} ≤ 5.5 V
Active Operation, Military	-55°C to +125°C	4.5 V ≤ V _{CC} ≤ 5.5 V
Data Retention, Commercial	0°C to +70°C	2.0 V ≤ V _{CC} ≤ 5.5 V
Data Retention, Military	-55°C to +125°C	2.0 V ≤ V _{CC} ≤ 5.5 V

ELECTRICAL CHARACTERISTICS Over Operating Conditions (Note 5)						
Symbol	Parameter	Test Condition	Min	Typ	Max	Unit
V _{OH}	Output High Voltage	I _{OH} = -4.0 mA, V _{CC} = 4.5 V	2.4			V
V _{OL}	Output Low Voltage	I _{OL} = 8.0 mA			0.4	V
V _{IH}	Input High Voltage		2.0		V _{CC} + 0.3	V
V _{IL}	Input Low Voltage	(Note 3)	-3.0		0.8	V
I _{Ix}	Input Current	GND ≤ V _{IN} ≤ V _{CC}	-10		+10	μA
I _{Oz}	Output Leakage Current	GND ≤ V _{OUT} ≤ V _{CC} , CE = V _{CC}	-10		+10	μA
I _{OS}	Output Short Current	V _{OUT} = GND, V _{CC} = Max (Note 4)			-350	mA
I _{CC2}	V _{CC} Current, TTL Inactive	(Note 7)		15	30	mA
I _{CC3}	V _{CC} Current, CMOS Standby	(Note 8)		100	500	μA
I _{CC4}	V _{CC} Current, Data Retention	V _{CC} = 3.0 V (Note 9)		10	250	μA
C _{IN}	Input Capacitance	Ambient Temp = 25°C, V _{CC} = 5.0 V			5	pF
C _{OUT}	Output Capacitance	Test Frequency = 1 MHz (Note 10)			7	pF

Symbol	Parameter	Test Condition	L7C164/165/166-							Unit
			35	25	20	15	12	10	8	
I _{CC1}	V _{CC} Current, Active	(Note 6)	75	100	125	160	190	205	225	mA



SWITCHING CHARACTERISTICS Over Operating Range (ns)

Symbol		Parameter		L7C164/165/166-													
				35		25		20		15		12		10		8	
				Min	Max	Min	Max	Min	Max	Min	Max	Min	Max	Min	Max	Min	Max
tAVAV	Read Cycle Time	35		25		20		15		12		10		8			
tAVQV	Address Valid to Output Valid (13, 14)		35		25		20		15		12		10		8		
tAXOX	Address Change to Output Change	3		3		3		3		3		3		3			
tCLQV	Chip Enable Low to Output Valid (13, 15)		35		25		20		15		12		10		8		
tCLQZ	Chip Enable Low to Output Low Z (20, 21)	3		3		3		3		3		3		3			
tCHOZ	Chip Enable High to Output High Z (20, 21)		15		10		8		8		5		4		4		
tOLQV	Output Enable Low to Output Valid		15		12		10		8		6		4		4		
tOLOZ	Output Enable Low to Output Low Z (20, 21)	0		0		0		0		0		0		0			
tOHOZ	Output Enable High to Output High Z (20, 21)		12		10		8		5		5		4		4		
tPU	Input Transition to Power Up (10, 19)	0		0		0		0		0		0		0			
tPD	Power Up to Power Down (10, 19)		35		25		20		20		20		18		15		
tCHVL	Chip Enable High to Data Retention (10)	0		0		0		0		0		0		0			

2

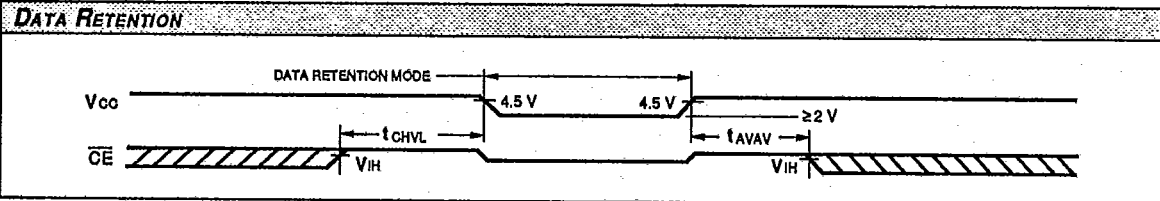
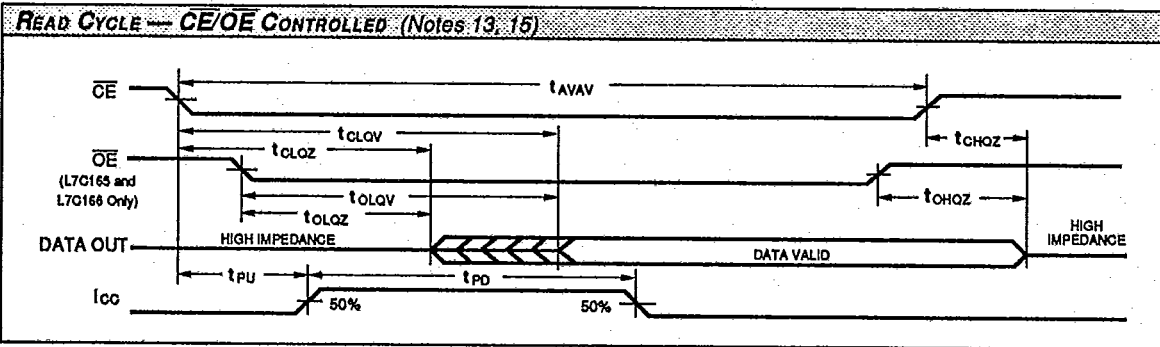
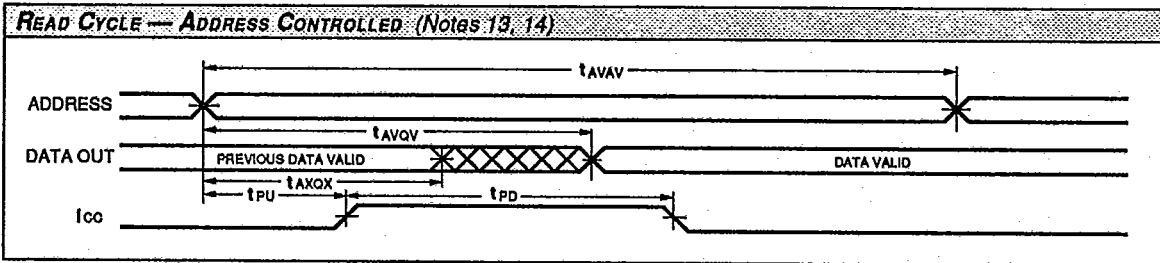

SWITCHING CHARACTERISTICS Over Operating Range (ns)

WRITE CYCLE (Notes 5, 11, 12, 22, 23, 24)

		L7C164/165/166-													
		35		25		20		15		12		10		8	
Symbol	Parameter	Min	Max	Min	Max	Min	Max	Min	Max	Min	Max	Min	Max	Min	Max
tAVAV	Write Cycle Time	25		20		20		15		12		10		8	
tCLEW	Chip Enable Low to End of Write Cycle	25		15		15		12		10		8		8	
tAVBW	Address Valid to Beginning of Write Cycle	0		0		0		0		0		0		0	
tAVEW	Address Valid to End of Write Cycle	25		15		15		12		10		8		8	
tEWAX	End of Write Cycle to Address Change	0		0		0		0		0		0		0	
twLEW	Write Enable Low to End of Write Cycle	20		15		15		12		10		8		6.5	
tDVEW	Data Valid to End of Write Cycle	15		10		10		7		6		5		4	
tEWDX	End of Write Cycle to Data Change	0		0		0		0		0		0		0	
tWHOZ	Write Enable High to Output Low Z (20, 21)	0		0		0		0		0		0		0	
twLQZ	Write Enable Low to Output High Z (20, 21)		10		7		7		5		4		4		3

WRITE CYCLE — WE CONTROLLED (Notes 16, 17, 18, 19)

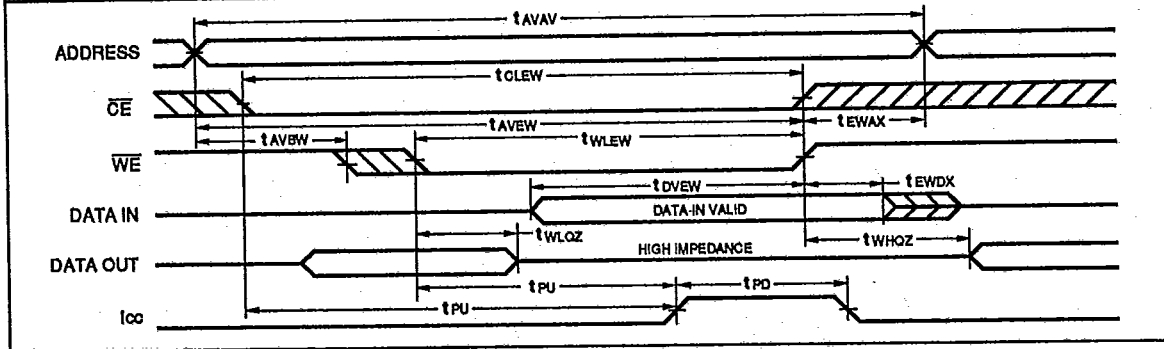

WRITE CYCLE — CE CONTROLLED (Notes 16, 17, 18, 19)

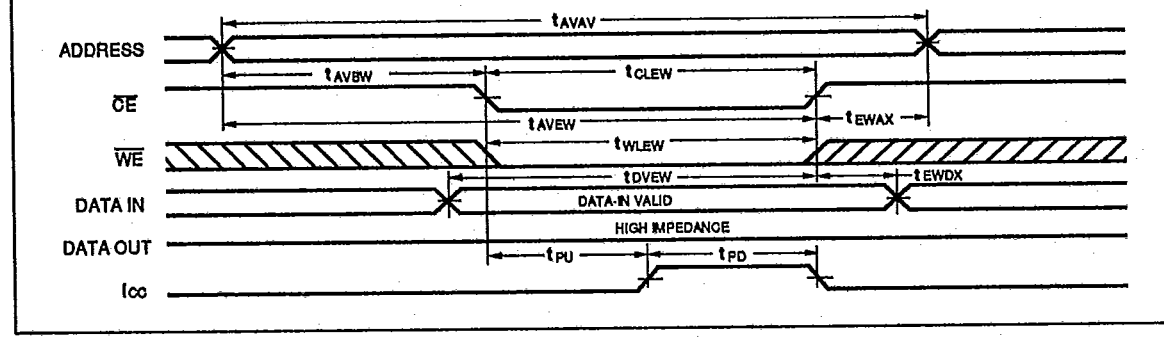

NOTES

1. Maximum Ratings indicate stress specifications only. Functional operation of these products at values beyond those indicated in the Operating Conditions table is not implied. Exposure to maximum rating conditions for extended periods may affect reliability of the tested device.
2. The products described by this specification include internal circuitry designed to protect the chip from damaging substrate injection currents and accumulations of static charge. Nevertheless, conventional precautions should be observed during storage, handling, and use of these circuits in order to avoid exposure to excessive electrical stress values.
3. This product provides hard clamping of transient undershoot. Input levels below ground will be clamped beginning at -0.6 V. A current in excess of 100 mA is required to reach -2 V. The device can withstand indefinite operation with inputs as low as -3 V subject only to power dissipation and bond wire fusing constraints.
4. Duration of the output short circuit should not exceed 30 seconds.
5. A series of normalized curves on pages 2-8 through 2-11 of this data book supply the designer with typical DC and AC parametric information for Logic Devices Static RAMs. These curves may be used to determine device characteristics at various temperatures and voltage levels.
6. Tested with all address and data inputs changing at the maximum cycle rate. The device is continuously enabled for writing, i.e., $CE^* \leq V_{IL}$, $WE \leq V_{IL}$. Input pulse levels are 0 to 3.0 V.
7. Tested with outputs open and all address and data inputs changing at the maximum read cycle rate. The device is continuously disabled, i.e., $CE^* \geq V_{IH}$.
8. Tested with outputs open and all address and data inputs stable. The device is continuously disabled, i.e., $CE^* = V_{CC}$. Input levels are within 0.2 V of VCC or ground.
9. Data retention operation requires that VCC never drop below 2.0 V. CE^* must be $\geq V_{CC} - 0.2$ V. For all other inputs $V_{IN} \geq V_{CC} - 0.2$ V or $V_{IN} \leq 0.2$ V is required to ensure full powerdown.
10. These parameters are guaranteed but not 100% tested.
11. Test conditions assume input transition times of less than 3 ns, reference levels of 1.5 V, output loading for specified IOL and

- I/OH plus 30 pF (Fig. 1a), and input pulse levels of 0 to 3.0 V (Fig. 2).
12. Each parameter is shown as a minimum or maximum value. Input requirements are specified from the point of view of the external system driving the chip. For example, t_{AV} is specified as a minimum since the external system must supply at least that much time to meet the worst-case requirements of all parts. Responses from the internal circuitry are specified from the point of view of the device. Access time, for example, is specified as a maximum since worst-case operation of any device always provides data within that time.
13. WE is high for the read cycle.
14. The chip is continuously selected (CE^* low).
15. All address lines are valid prior to or coincident with the CE^* transition to low.
16. The internal write cycle of the memory is defined by the overlap of CE^* low and WE low. Both signals must be low to initiate a write. Either signal can terminate a write by going high. The address, data, and control input setup and hold times should be referenced to the signal that falls last or rises first.
17. If WE goes low before or concurrent with CE^* going low, the output remains in a high impedance state.
18. If CE^* goes high before or concurrent with WE going high, the output remains in a high impedance state.
19. Powerup from ICC2 to ICC1 occurs as a result of any of the following conditions:
 - a. Falling edge of CE^* .
 - b. Falling edge of WE (CE^* active).
 - c. Transition on any address line (CE^* active).
 - d. Transition on any data line (CE^* and WE active).
- The device automatically powers down from ICC2 to ICC1 after t_{PD} has elapsed from any of the prior conditions. This means that power dissipation is dependent on only cycle rate, and is not on Chip Select pulse width.
20. At any given temperature and voltage condition, output disable time is less than output enable time for any given device.
21. Transition is measured ± 200 mV from steady state voltage with specified loading in Fig. 1b. This parameter is sampled and not 100% tested.
22. All address timings are referenced from the last valid address line to the first transitioning address line.
23. CE^* or WE must be high during address transitions.
24. This product is a very high speed device and care must be taken during testing in order to realize valid test information. Inadequate attention to setups and procedures can cause a good part to be rejected as faulty. Long high inductance leads that cause supply bounce must be avoided by bringing the VCC and ground planes directly up to the contactor fingers. A 0.01 μ F high frequency capacitor is also required between VCC and ground. To avoid signal reflections, proper terminations must be used.

2

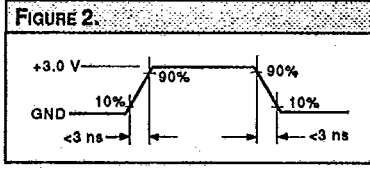
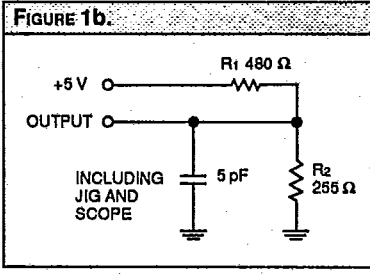
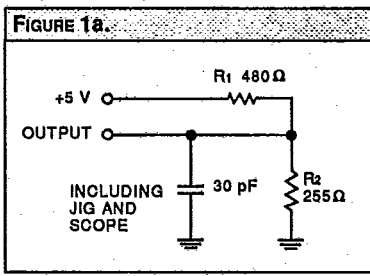

* For the L7C165, CE refers to the logical AND of CE_1 and CE_2 .

L7C164 — ORDERING INFORMATION

22-pin
(0.3" wide)

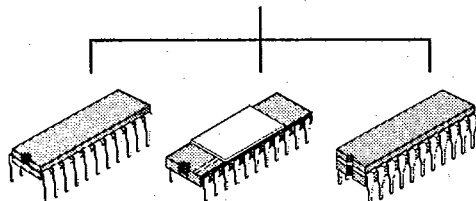
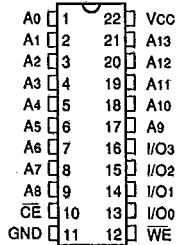

24-pin

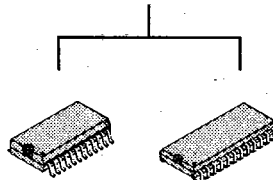
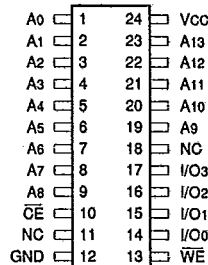

22-pin
(290 x 490)

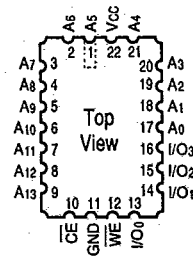

Speed	Plastic DIP (P8)	Sidebraze Hermetic DIP (D8)	CerDIP (C3)	Plastic SOIC (.300" — U1)	Plastic SOJ (.300" — W1)	Ceramic Leadless Chip Carrier (K4)
0°C to +70°C — COMMERCIAL SCREENING						
35 ns	L7C164PC35	L7C164DC35	L7C164CC35	L7C164UC35	L7C164WC35	L7C164KC35
25 ns	• • 25	• • 25	• • 25	• • 25	• • 25	• • 25
20 ns	• • 20	• • 20	• • 20	• • 20	• • 20	• • 20
15 ns	• • 15	• • 15	• • 15	• • 15	• • 15	• • 15
12 ns	• • 12	• • 12	• • 12	• • 12	• • 12	• • 12
10 ns	• • 10	• • 10	• • 10	• • 10	• • 10	• • 10
8 ns	• • 8	• • 8	• • 8	• • 8	• • 8	• • 8
-55°C to +125°C — COMMERCIAL SCREENING						
35 ns		L7C164DM35	L7C164CM35			L7C164KM35
25 ns		• • 25	• • 25			• • 25
20 ns		• • 20	• • 20			• • 20
15 ns		• • 15	• • 15			• • 15
12 ns		• • 12	• • 12			• • 12
10 ns		• • 10	• • 10			• • 10
8 ns						
-55°C to +125°C — EXTENDED SCREENING						
35 ns		L7C164DME35	L7C164CME35			L7C164KME35
25 ns		• • 25	• • 25			• • 25
20 ns		• • 20	• • 20			• • 20
15 ns		• • 15	• • 15			• • 15
12 ns		• • 12	• • 12			• • 12
10 ns		• • 10	• • 10			• • 10
8 ns						
-55°C to +125°C — MIL-STD-883 COMPLIANT						
35 ns		L7C164DMB35	L7C164CMB35			L7C164KMB35
25 ns		• • 25	• • 25			• • 25
20 ns		• • 20	• • 20			• • 20
15 ns		• • 15	• • 15			• • 15
12 ns		• • 12	• • 12			• • 12
10 ns		• • 10	• • 10			• • 10
8 ns						



DEVICES INCORPORATED

Memory Products

2

L7C165/166 — ORDERING INFORMATION

24-pin
(0.3" wide)

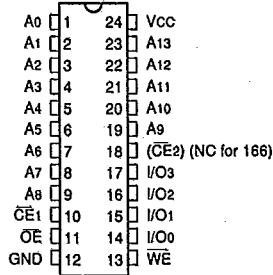

24-pin

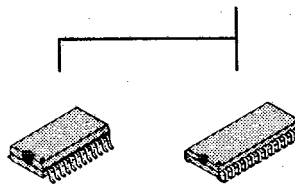
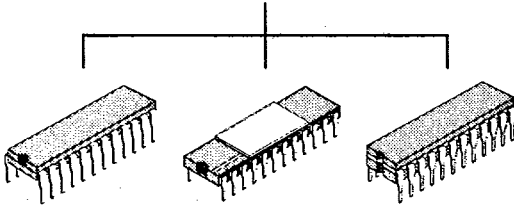
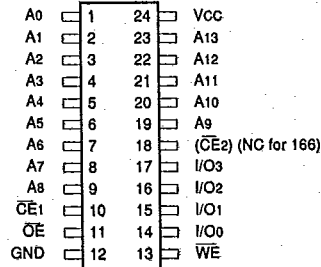

Speed	Plastic DIP (P2)	Sidebraze Hermetic DIP (D2)	CerDIP (C1)	Plastic SOIC (.300" — U1)	Plastic SOJ (.300" — W1)				
0°C to +70°C — COMMERCIAL SCREENING									
35 ns	L7C165PC or L7C166PC	L7C165DC or L7C166DC	L7C165CC or L7C166CC	L7C165UC or L7C166UC	L7C165WC or L7C166WC				
25 ns						35	35	35	35
20 ns						25	25	25	25
15 ns						20	20	20	20
12 ns						15	15	15	15
10 ns						12	12	12	12
8 ns						10	10	10	10
8 ns	8	8	8	8	8				
-55°C to +125°C — COMMERCIAL SCREENING									
35 ns		L7C165DM or L7C166DM	L7C165CM or L7C166CM						
25 ns				35	35				
20 ns				25	25				
15 ns				20	20				
12 ns				15	15				
10 ns				12	12				
8 ns				10	10				
-55°C to +125°C — EXTENDED SCREENING									
35 ns		L7C165DME or L7C166DME	L7C165CME or L7C166CME						
25 ns				35	35				
20 ns				25	25				
15 ns				20	20				
12 ns				15	15				
10 ns				12	12				
8 ns				10	10				
-55°C to +125°C — MIL-STD-883 COMPLIANT									
35 ns		L7C165DMB or L7C166DMB	L7C165CMB or L7C166CMB						
25 ns				35	35				
20 ns				25	25				
15 ns				20	20				
12 ns				15	15				
10 ns				12	12				
8 ns				10	10				

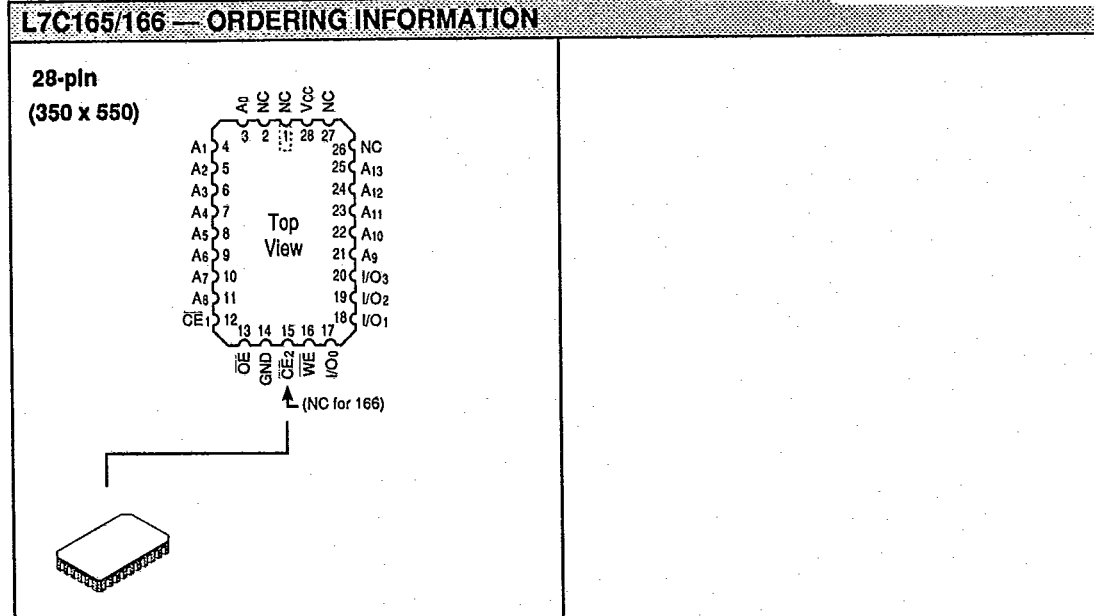

Speed	Ceramic Leadless Chip Carrier (K5)				
0°C to +70°C — COMMERCIAL SCREENING					
35 ns	L7C165KC or L7C166KC	35			
25 ns		25			
20 ns		20			
15 ns		15			
12 ns		12			
10 ns		10			
8 ns	8				
-55°C to +125°C — COMMERCIAL SCREENING					
35 ns	L7C165KM or L7C166KM	35			
25 ns		25			
20 ns		20			
15 ns		15			
12 ns		12			
10 ns		10			
8 ns					
-55°C to +125°C — EXTENDED SCREENING					
35 ns	L7C165KME or L7C166KME	35			
25 ns		25			
20 ns		20			
15 ns		15			
12 ns		12			
10 ns		10			
8 ns					
-55°C to +125°C — MIL-STD-883 COMPLIANT					
35 ns	L7C165KMB or L7C166KMB	35			
25 ns		25			
20 ns		20			
15 ns		15			
12 ns		12			
10 ns		10			
8 ns					



DEVICES INCORPORATED

Memory Products