

KST4401

KST4401

Switching Transistor

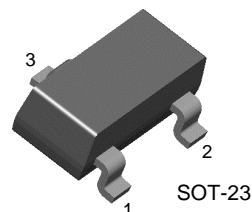

1. Base 2. Emitter 3. Collector

NPN Epitaxial Silicon Transistor

Absolute Maximum Ratings $T_a=25^\circ\text{C}$ unless otherwise noted

Symbol	Parameter	Value	Units
V_{CBO}	Collector-Base Voltage	60	V
V_{CEO}	Collector-Emitter Voltage	40	V
V_{EBO}	Emitter-Base Voltage	6	V
I_C	Collector Current	600	mA
P_C	Collector Dissipation	350	mW
T_{STG}	Storage Temperature	150	$^\circ\text{C}$

Electrical Characteristics $T_a=25^\circ\text{C}$ unless otherwise noted

Symbol	Parameter	Test Condition	Min.	Max.	Units
BV_{CBO}	Collector-Base Breakdown Voltage	$I_C=100\mu\text{A}, I_E=0$	60		V
BV_{CEO}	* Collector-Emitter Breakdown Voltage	$I_C=1.0\text{mA}, I_B=0$	40		V
BV_{EBO}	Emitter-Base Breakdown Voltage	$I_E=100\mu\text{A}, I_C=0$	6		V
I_{BEV}	Base Cut-off Current	$V_{CE}=35\text{V}, V_{EB}=0.4\text{V}$		100	nA
I_{CEX}	Collector Cut-off Current	$V_{CE}=35\text{V}, V_{EB}=0.4\text{V}$		100	nA
h_{FE}	* DC Current Gain	$V_{CE}=1\text{V}, I_C=0.1\text{mA}$ $V_{CE}=1\text{V}, I_C=1\text{mA}$ $V_{CE}=1\text{V}, I_C=10\text{mA}$ $V_{CE}=1\text{V}, I_C=150\text{mA}$ $V_{CE}=2\text{V}, I_C=500\text{mA}$	20 40 80 100 40	300	
$V_{CE(sat)}$	* Collector-Emitter Saturation Voltage	$I_C=150\text{mA}, I_B=15\text{mA}$ $I_C=500\text{mA}, I_B=50\text{mA}$		0.4 0.75	V V
$V_{BE(sat)}$	* Base-Emitter Saturation Voltage	$I_C=150\text{mA}, I_B=15\text{mA}$ $I_C=500\text{mA}, I_B=50\text{mA}$	0.75	0.95 1.2	V V
f_T	Current Gain Bandwidth Product	$I_C=20\text{mA}, V_{CE}=10\text{V}$ $f=100\text{MHz}$	250		MHz
C_{ob}	Output Capacitance	$V_{CB}=5\text{V}, I_E=0, f=100\text{KHz}$		6.5	pF
t_{ON}	Turn On Time	$V_{CC}=30\text{V}, V_{BE}=2\text{V}$ $I_C=150\text{mA}, I_{B1}=15\text{mA}$		35	ns
t_{OFF}	Turn Off Time	$V_{CC}=30\text{V}, I_C=150\text{mA}$ $I_{B1}=I_{B2}=15\text{mA}$		255	ns

* Pulse Test: Pulse Width $\leq 300\mu\text{s}$, Duty Cycle $\leq 2\%$

Marking

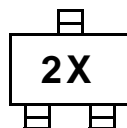

Typical Characteristics

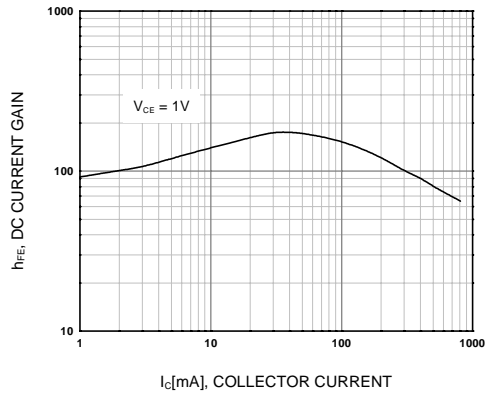

Figure 1. DC current Gain

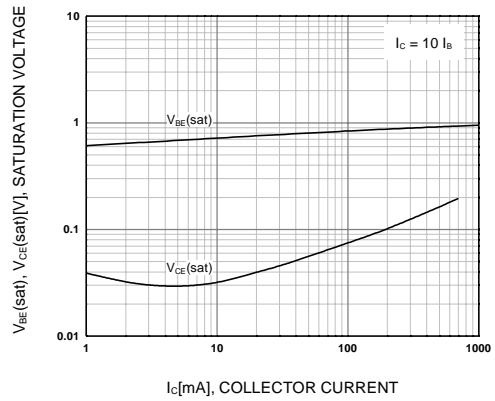

Figure 2. Collector-Emitter Saturation Voltage
Base-Emitter Saturation Voltage

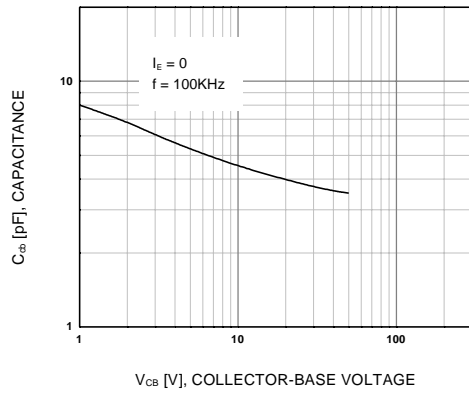

Figure 3. Collector-Base Capacitance

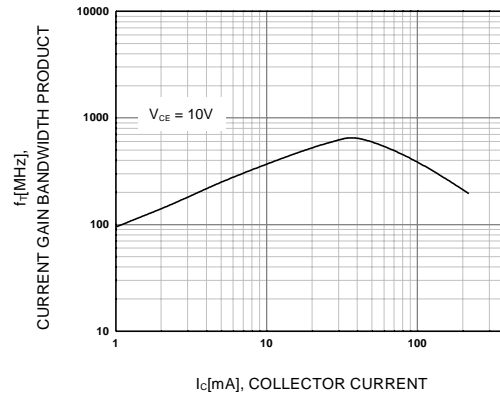
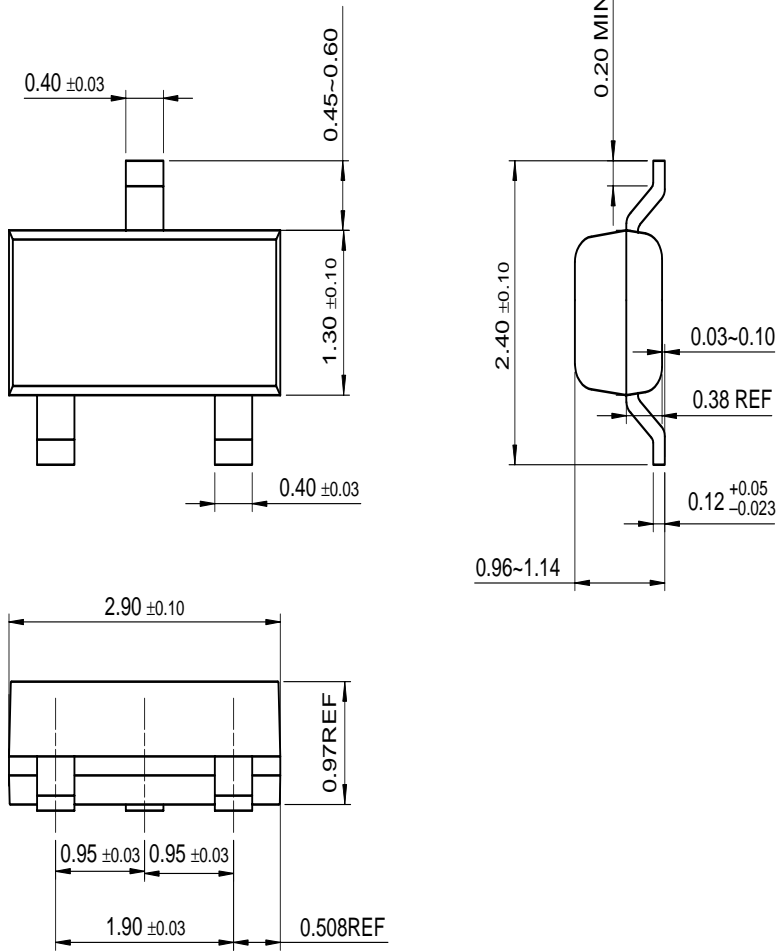

Figure 4. Current Gain Bandwidth Product

Package Dimensions

SOT-23



Dimensions in Millimeters

TRADEMARKS

The following are registered and unregistered trademarks Fairchild Semiconductor owns or is authorized to use and is not intended to be an exhaustive list of all such trademarks.

ACEx™	FAST®	OPTOPLANAR™	STAR*POWER™
Bottomless™	FASTr™	PACMAN™	Stealth™
CoolFET™	FRFET™	POP™	SuperSOT™-3
CROSSVOLT™	GlobalOptoisolator™	Power247™	SuperSOT™-6
DenseTrench™	GTO™	PowerTrench®	SuperSOT™-8
DOMET™	HiSeC™	QFET™	SyncFET™
EcoSPARK™	ISOPLANAR™	QS™	TruTranslation™
E ² CMOS™	LittleFET™	QT Optoelectronics™	TinyLogic™
EnSigna™	MicroFET™	Quiet Series™	UHC™
FACT™	MICROWIRE™	SLIENT SWITCHER®	UltraFET®
FACT Quiet Series™	OPTOLOGIC™	SMART START™	VCX™

STAR*POWER is used under license

DISCLAIMER

FAIRCHILD SEMICONDUCTOR RESERVES THE RIGHT TO MAKE CHANGES WITHOUT FURTHER NOTICE TO ANY PRODUCTS HEREIN TO IMPROVE RELIABILITY, FUNCTION OR DESIGN. FAIRCHILD DOES NOT ASSUME ANY LIABILITY ARISING OUT OF THE APPLICATION OR USE OF ANY PRODUCT OR CIRCUIT DESCRIBED HEREIN; NEITHER DOES IT CONVEY ANY LICENSE UNDER ITS PATENT RIGHTS, NOR THE RIGHTS OF OTHERS.

LIFE SUPPORT POLICY

FAIRCHILD'S PRODUCTS ARE NOT AUTHORIZED FOR USE AS CRITICAL COMPONENTS IN LIFE SUPPORT DEVICES OR SYSTEMS WITHOUT THE EXPRESS WRITTEN APPROVAL OF FAIRCHILD SEMICONDUCTOR CORPORATION.

As used herein:

- Life support devices or systems are devices or systems which, (a) are intended for surgical implant into the body, or (b) support or sustain life, or (c) whose failure to perform when properly used in accordance with instructions for use provided in the labeling, can be reasonably expected to result in significant injury to the user.
- A critical component is any component of a life support device or system whose failure to perform can be reasonably expected to cause the failure of the life support device or system, or to affect its safety or effectiveness.

PRODUCT STATUS DEFINITIONS

Definition of Terms

Datasheet Identification	Product Status	Definition
Advance Information	Formative or In Design	This datasheet contains the design specifications for product development. Specifications may change in any manner without notice.
Preliminary	First Production	This datasheet contains preliminary data, and supplementary data will be published at a later date. Fairchild Semiconductor reserves the right to make changes at any time without notice in order to improve design.
No Identification Needed	Full Production	This datasheet contains final specifications. Fairchild Semiconductor reserves the right to make changes at any time without notice in order to improve design.
Obsolete	Not In Production	This datasheet contains specifications on a product that has been discontinued by Fairchild semiconductor. The datasheet is printed for reference information only.