



Features

- Write Protect Pin for Hardware Data Protection
 - Utilizes Different Array Protection Compared to the AT24C02/04/08
- Low Voltage and Standard Voltage Operation
 - 5.0 ($V_{CC} = 4.5V$ to $5.5V$)
 - 2.7 ($V_{CC} = 2.7V$ to $5.5V$)
 - 2.5 ($V_{CC} = 2.5V$ to $5.5V$)
 - 1.8 ($V_{CC} = 1.8V$ to $5.5V$)
- Internally Organized 256 x 8 (2K), 512 x 8 (4K) or 1024 x 8 (8K)
- 2-Wire Serial Interface
- Schmitt Trigger, Filtered Inputs for Noise Suppression
- Bidirectional Data Transfer Protocol
- 100 kHz (1.8V, 2.5V, 2.7V) and 400 kHz (5V) Compatibility
- 8-Byte Page (2K), 16-Byte Page (4K, 8K) Write Modes
- Partial Page Writes Are Allowed
- Self-Timed Write Cycle (10 ms max)
- High Reliability
 - Endurance: 1 Million Write Cycles
 - Data Retention: 100 Years
 - ESD Protection: >3000V
- Automotive Grade and Extended Temperature Devices Available
- 8-Pin and 14-Pin JEDEC SOIC, 8-Pin PDIP, and 8-Pin TSSOP Packages

2-Wire Serial EEPROM

2K (256 x 8)

4K (512 x 8)

8K (1024 x 8)

AT24C02A

AT24C04A

AT24C08A

Description

The AT24C02A/04A/08A provides 2048/4096/8192 bits of serial electrically erasable and programmable read only memory (EEPROM) organized as 256/512/1024 words of 8 bits each. The device is optimized for use in many industrial and commercial applications where low power and low voltage operation are essential. The AT24C02A/04A/08A is available in space saving 8-pin PDIP, 8-pin and 14-pin JEDEC SOIC, and 8-pin TSSOP packages and is accessed via a 2-wire serial interface. In addition, the entire family is available in 5.0V (4.5V to 5.5V), 2.7V (2.7V to 5.5V), 2.5V (2.5V to 5.5V) and 1.8V (1.8V to 5.5V) versions.

Pin Configurations

Pin Name	Function
A0 - A2	Address Inputs
SDA	Serial Data
SCL	Serial Clock Input
WP	Write Protect
NC	No Connect

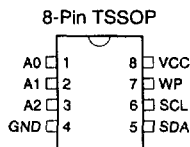
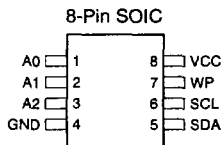
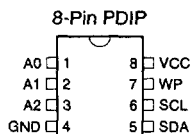
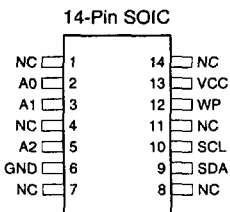

Rev. 0976B-07/98



Absolute Maximum Ratings*

Operating Temperature.....	-55°C to +125°C
Storage Temperature.....	-65°C to +150°C
Voltage on Any Pin with Respect to Ground.....	-1.0V to +7.0V
Maximum Operating Voltage.....	6.25V
DC Output Current.....	5.0 mA

*NOTICE: Stresses beyond those listed under "Absolute Maximum Ratings" may cause permanent damage to the device. This is a stress rating only and functional operation of the device at these or any other conditions beyond those indicated in the operational sections of this specification is not implied. Exposure to absolute maximum rating conditions for extended periods may affect device reliability.

Block Diagram

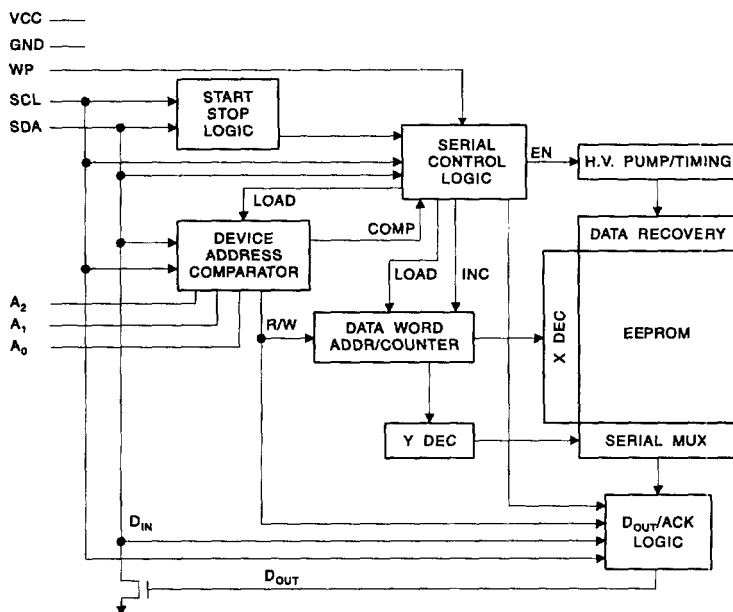

Pin Description

SERIAL CLOCK (SCL): The SCL input is used to positive edge clock data into each EEPROM device and negative edge clock data out of each device.

SERIAL DATA (SDA): The SDA pin is bidirectional for serial data transfer. This pin is open-drain driven and may be wire-ORed with any number of other open-drain or open collector devices.

DEVICE/PAGE ADDRESSES (A2, A1, A0): The A2, A1 and A0 pins are device address inputs that are hard wired for the AT24C02A. As many as eight 2K devices may be addressed on a single bus system (device addressing is discussed in detail under the Device Addressing section).

The AT24C04A uses the A2 and A1 inputs for hard wire addressing and a total of four 4K devices may be addressed on a single bus system. The A0 pin is a no connect.

The AT24C08A only uses the A2 input for hardware addressing and a total of two 8K devices may be addressed on a single bus system. The A0 and A1 pins are no connects.

WRITE PROTECT (WP): The AT24C02A/04A/08A has a Write Protect pin that provides hardware data protection. The Write Protect pin allows normal read/write operations when connected to ground (GND). When the Write Protect

pin is connected to V_{CC} , the write protection feature is enabled and operates as shown in the following table.

WP Pin Status	Part of the Array Protected		
	24C02A	24C04A	24C08A
At V_{CC}	Upper Half (1K) Array	Upper Half (2K) Array	Full (8K) Array
At GND	Normal Read/Write Operations		

Memory Organization

AT24C02A, 2K SERIAL EEPROM: Internally organized with 256 pages of 1-byte each, the 2K requires an 8 bit data word address for random word addressing.

AT24C04A, 4K SERIAL EEPROM: The 4K is internally organized with 256 pages of 2-bytes each. Random word addressing requires a 9 bit data word address.

AT24C08A, 8K SERIAL EEPROM: The 8K is internally organized with 4 blocks of 256 pages of 4-bytes each. Random word addressing requires a 10 bit data word address.

2

Pin Capacitance

Applicable over recommended operating range from $T_A = 25^\circ\text{C}$, $f = 1.0\text{ MHz}$, $V_{CC} = +1.8\text{V}$.

Symbol	Test Condition	Max	Units	Conditions
$C_{I/O}$	Input/Output Capacitance (SDA)	8	pF	$V_{I/O} = 0\text{V}$
C_{IN}	Input Capacitance ($A_0, A_1, A_2, \text{SCL}$)	6	pF	$V_{IN} = 0\text{V}$

Note: 1. This parameter is characterized and is not 100% tested.

DC Characteristics

Applicable over recommended operating range from: $T_{AI} = -40^\circ\text{C}$ to $+85^\circ\text{C}$, $V_{CC} = +1.8\text{V}$ to $+5.5\text{V}$, $T_{AC} = 0^\circ\text{C}$ to $+70^\circ\text{C}$, $V_{CC} = +1.8\text{V}$ to $+5.5\text{V}$ (unless otherwise noted).

Symbol	Parameter	Test Condition	Min	Typ	Max	Units
V_{CC1}	Supply Voltage		1.8		5.5	V
V_{CC2}	Supply Voltage		2.5		5.5	V
V_{CC3}	Supply Voltage		2.7		5.5	V
V_{CC4}	Supply Voltage		4.5		5.5	V
I_{CC}	Supply Current $V_{CC} = 5.0\text{V}$	READ at 100 kHz		0.4	1.0	mA
I_{CC}	Supply Current $V_{CC} = 5.0\text{V}$	WRITE at 100 kHz		2.0	3.0	mA
I_{SB1}	Standby Current $V_{CC} = 1.8\text{V}$	$V_{IN} = V_{CC}$ or V_{SS}		0.6	3.0	μA
I_{SB2}	Standby Current $V_{CC} = 2.5\text{V}$	$V_{IN} = V_{CC}$ or V_{SS}		1.4	4.0	μA
I_{SB3}	Standby Current $V_{CC} = 2.7\text{V}$	$V_{IN} = V_{CC}$ or V_{SS}		1.6	4.0	μA
I_{SB4}	Standby Current $V_{CC} = 5.0\text{V}$	$V_{IN} = V_{CC}$ or V_{SS}		8.0	18.0	μA
I_{LI}	Input Leakage Current	$V_{IN} = V_{CC}$ or V_{SS}		0.10	3.0	μA
I_{LO}	Output Leakage Current	$V_{OUT} = V_{CC}$ or V_{SS}		0.05	3.0	μA
V_{IL}	Input Low Level ⁽¹⁾		-0.6		$V_{CC} \times 0.3$	V
V_{IH}	Input High Level ⁽¹⁾		$V_{CC} \times 0.7$		$V_{CC} + 0.5$	V
V_{OL2}	Output Low Level $V_{CC} = 3.0\text{V}$	$I_{OL} = 2.1\text{ mA}$			0.4	V
V_{OL1}	Output Low Level $V_{CC} = 1.8\text{V}$	$I_{OL} = 0.15\text{ mA}$			0.2	V

Note: 1. V_{IL} min and V_{IH} max are reference only and are not tested.



AC Characteristics

Applicable over recommended operating range from $T_A = -40^\circ\text{C}$ to $+85^\circ\text{C}$, $V_{CC} = +1.8\text{V}$ to $+5.5\text{V}$, $CL = 1$ TTL Gate and 100 pF (unless otherwise noted).

Symbol	Parameter	2.7-, 2.5-, 1.8-volt		5.0-volt		Units
		Min	Max	Min	Max	
f_{SCL}	Clock Frequency, SCL		100		400	kHz
t_{LOW}	Clock Pulse Width Low	4.7		1.2		μs
t_{HIGH}	Clock Pulse Width High	4.0		0.6		μs
t_i	Noise Suppression Time ⁽¹⁾		100		50	ns
t_{AA}	Clock Low to Data Out Valid	0.1	4.5	0.1	0.9	μs
t_{BUF}	Time the bus must be free before a new transmission can start ⁽¹⁾	4.7		1.2		μs
$t_{HD,STA}$	Start Hold Time	4.0		0.6		μs
$t_{SU,STA}$	Start Set-up Time	4.7		0.6		μs
$t_{HD,DAT}$	Data In Hold Time	0		0		μs
$t_{SU,DAT}$	Data In Set-up Time	200		100		ns
t_R	Inputs Rise Time ⁽¹⁾		1.0		0.3	μs
t_F	Inputs Fall Time ⁽¹⁾		300		300	ns
$t_{SU,STO}$	Stop Set-up Time	4.7		0.6		μs
t_{DH}	Data Out Hold Time	100		50		ns
t_{WR}	Write Cycle Time		10		10	ms
Endurance ⁽¹⁾	5.0V, 25°C, Page Mode	1M		1M		Write Cycles

Note: 1. This parameter is characterized and is not 100% tested.

Device Operation

CLOCK and DATA TRANSITIONS: The SDA pin is normally pulled high with an external device. Data on the SDA pin may change only during SCL low time periods (refer to Data Validity timing diagram). Data changes during SCL high periods will indicate a start or stop condition as defined below.

START CONDITION: A high-to-low transition of SDA with SCL high is a start condition which must precede any other command (refer to Start and Stop Definition timing diagram).

STOP CONDITION: A low-to-high transition of SDA with SCL high is a stop condition. After a read sequence, the stop command will place the EEPROM in a standby power mode (refer to Start and Stop Definition timing diagram).

ACKNOWLEDGE: All addresses and data words are serially transmitted to and from the EEPROM in 8 bit words. The EEPROM sends a zero to acknowledge that it has received each word. This happens during the ninth clock cycle.

STANDBY MODE: The AT24C02A/04A/08A features a low power standby mode which is enabled: (a) upon power-up and (b) after the receipt of the STOP bit and the completion of any internal operations.

MEMORY RESET: After an interruption in protocol, power loss or system reset, any 2-wire part can be reset by following these steps: (a) Clock up to 9 cycles, (b) look for SDA high in each cycle while SCL is high and then (c) create a start condition as SDA is high.

Bus Timing (SCL: Serial Clock, SDA: Serial Data I/O)

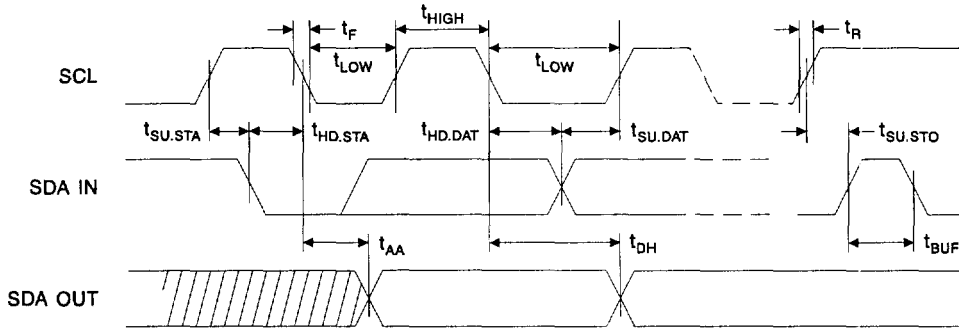

2

Write Cycle Timing (SCL: Serial Clock, SDA: Serial Data I/O)

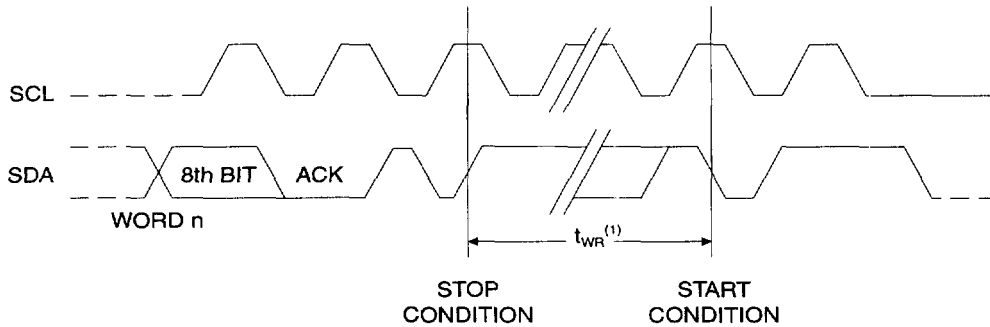

Note: 1. The write cycle time t_{WR} is the time from a valid stop condition of a write sequence to the end of the interval clear/write cycle.

Data Validity

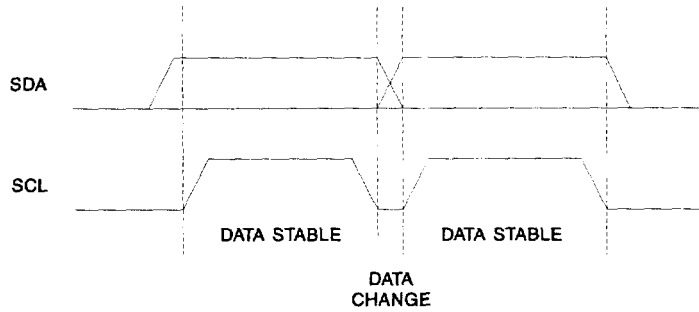

Start and Stop Definition

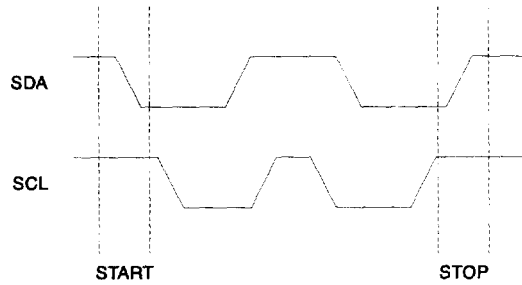

Output Acknowledge

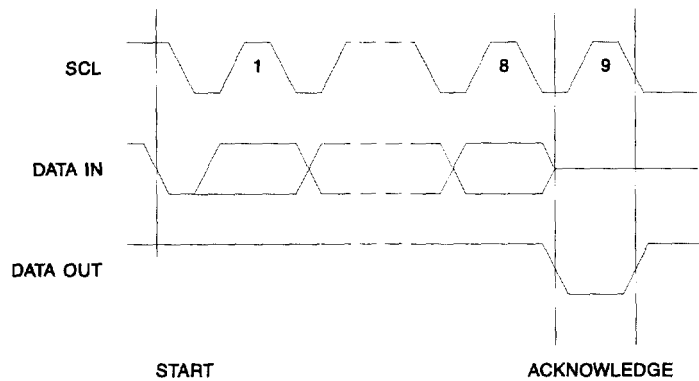

Device Addressing

The 2K, 4K and 8K EEPROM devices all require an 8 bit device address word following a start condition to enable the chip for a read or write operation (refer to Figure 1).

The device address word consists of a mandatory one, zero sequence for the first four most significant bits as shown. This is common to all the EEPROM devices.

The next 3 bits are the A2, A1 and A0 device address bits for the 2K EEPROM. These 3 bits must compare to their corresponding hard-wired input pins.

The 4K EEPROM only uses the A2 and A1 device address bits with the third bit being a memory page address bit. The two device address bits must compare to their corresponding hard-wired input pins. The A0 pin is no connect.

The 8K EEPROM only uses the A2 device address bit with the next 2 bits being for memory page addressing. The A2 bit must compare to its corresponding hard-wired input pin. The A1 and A0 pins are no connect.

The eighth bit of the device address is the read/write operation select bit. A read operation is initiated if this bit is high and a write operation is initiated if this bit is low.

Upon a compare of the device address, the EEPROM will output a zero. If a compare is not made, the chip will return to a standby state.

Write Operations

BYTE WRITE: A write operation requires an 8 bit data word address following the device address word and acknowledgement. Upon receipt of this address, the EEPROM will again respond with a zero and then clock in the first 8 bit data word. Following receipt of the 8 bit data word, the EEPROM will output a zero and the addressing device, such as a microcontroller, must terminate the write sequence with a stop condition. At this time the EEPROM enters an internally-timed write cycle, t_{WR} , to the nonvolatile memory. All inputs are disabled during this write cycle and the EEPROM will not respond until the write is complete (refer to Figure 2).

PAGE WRITE: The 2K EEPROM is capable of an 8-byte page write, and the 4K and 8K devices are capable of 16-byte page writes.

A page write is initiated the same as a byte write, but the microcontroller does not send a stop condition after the first data word is clocked in. Instead, after the EEPROM acknowledges receipt of the first data word, the microcontroller can transmit up to seven (2K) or fifteen (4K, 8K) more data words. The EEPROM will respond with a zero after each data word received. The microcontroller must terminate the page write sequence with a stop condition (refer to Figure 3).

The data word address lower three (2K) or four (4K, 8K) bits are internally incremented following the receipt of each data word. The higher data word address bits are not incremented, retaining the memory page row location. When the word address, internally generated, reaches the page boundary, the following byte is placed at the beginning of the same page. If more than eight (2K) or sixteen (4K, 8K) data words are transmitted to the EEPROM, the data word address will "roll over" and previous data will be overwritten.

ACKNOWLEDGE POLLING: Once the internally-timed write cycle has started and the EEPROM inputs are disabled, acknowledge polling can be initiated. This involves sending a start condition followed by the device address word. The read/write bit is representative of the operation desired. Only if the internal write cycle has completed will the EEPROM respond with a zero allowing the read or write sequence to continue.

Read Operations

Read operations are initiated the same way as write operations with the exception that the read/write select bit in the device address word is set to one. There are three read operations: current address read, random address read and sequential read.

CURRENT ADDRESS READ: The internal data word address counter maintains the last address accessed during the last read or write operation, incremented by one. This address stays valid between operations as long as the chip power is maintained. The address "roll over" during read is from the last byte of the last memory page to the first byte of the first page. The address "roll over" during write is from the last byte of the current page to the first byte of the same page.

Once the device address with the read/write select bit set to one is clocked in and acknowledged by the EEPROM, the current address data word is serially clocked out. The microcontroller does not respond with an input zero but does generate a following stop condition (refer to Figure 4).

RANDOM READ: A random read requires a "dummy" byte write sequence to load in the data word address. Once the device address word and data word address are clocked in and acknowledged by the EEPROM, the microcontroller must generate another start condition. The microcontroller now initiates a current address read by sending a device address with the read/write select bit high. The EEPROM acknowledges the device address and serially clocks out the data word. The microcontroller does not respond with a zero but does generate a following stop condition (refer to Figure 5).

SEQUENTIAL READ: Sequential reads are initiated by either a current address read or a random address read. After the microcontroller receives a data word, it responds

with an acknowledge. As long as the EEPROM receives an acknowledge, it will continue to increment the data word address and serially clock out sequential data words. When the memory address limit is reached, the data word

address will "roll over" and the sequential read will continue. The sequential read operation is terminated when the microcontroller does not respond with a zero but does generate a following stop condition (refer to Figure 6).

Figure 1. Device Address

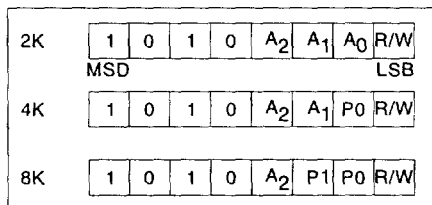

Figure 2. Byte Write

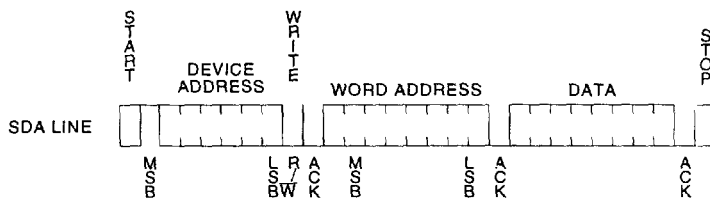

Figure 3. Page Write

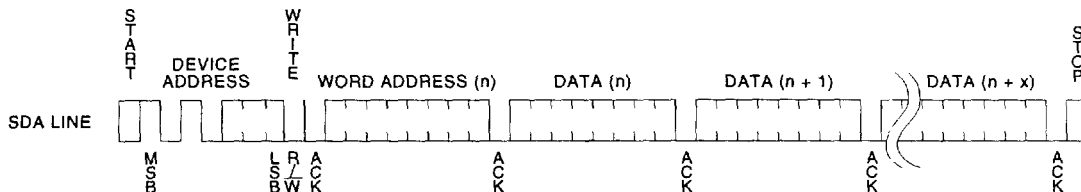
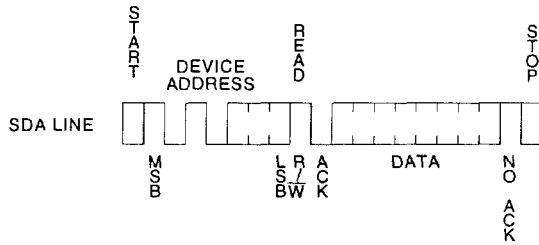

Figure 4. Current Address Read



2

Figure 5. Random Read

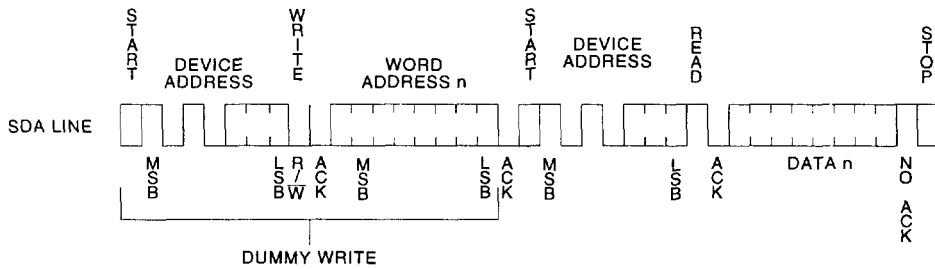
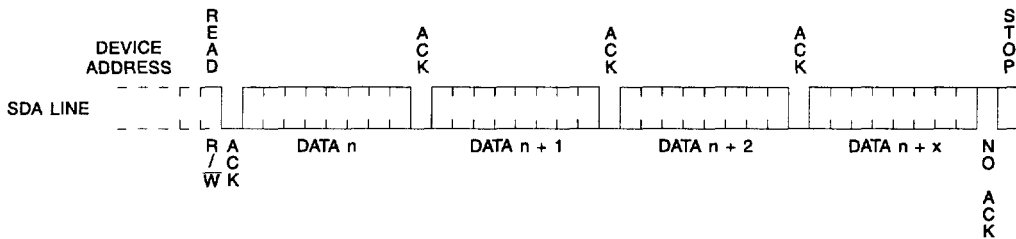

Figure 6. Sequential Read





AT24C02A Ordering Information

t_{WR} (max) (ms)	I_{CC} (max) (μ A)	I_{SB} (max) (μ A)	f_{MAX} (kHz)	Ordering Code	Package	Operation Range
10	3000	18	400	AT24C02A-10PC	8P3	Commercial (0°C to 70°C)
				AT24C02AN-10SC	8S1	
				AT24C02A-10SC	14S	
				AT24C02A-10TC	8T	
10	3000	18	400	AT24C02A-10PI	8P3	Industrial (-40°C to 85°C)
				AT24C02AN-10SI	8S1	
				AT24C02A-10SI	14S	
				AT24C02A-10TI	8T	
10	1500	4	100	AT24C02A-10PC-2.7	8P3	Commercial (0°C to 70°C)
				AT24C02AN-10SC-2.7	8S1	
				AT24C02A-10SC-2.7	14S	
				AT24C02A-10TC-2.7	8T	
10	1500	4	100	AT24C02A-10PI-2.7	8P3	Industrial (-40°C to 85°C)
				AT24C02AN-10SI-2.7	8S1	
				AT24C02A-10SI-2.7	14S	
				AT24C02A-10TI-2.7	8T	
10	1000	4	100	AT24C02A-10PC-2.5	8P3	Commercial (0°C to 70°C)
				AT24C02AN-10SC-2.5	8S1	
				AT24C02A-10SC-2.5	14S	
				AT24C02A-10TC-2.5	8T	
10	1000	4	100	AT24C02A-10PI-2.5	8P3	Industrial (-40°C to 85°C)
				AT24C02AN-10SI-2.5	8S1	
				AT24C02A-10SI-2.5	14S	
				AT24C02A-10TI-2.5	8T	
10	800	3	100	AT24C02A-10PC-1.8	8P3	Commercial (0°C to 70°C)
				AT24C02AN-10SC-1.8	8S1	
				AT24C02A-10SC-1.8	14S	
				AT24C02A-10TC-1.8	8T	
10	800	3	100	AT24C02A-10PI-1.8	8P3	Industrial (-40°C to 85°C)
				AT24C02AN-10SI-1.8	8S1	
				AT24C02A-10SI-1.8	14S	
				AT24C02A-10TI-1.8	8T	

Package Type

8P3	8-Lead, 0.300" Wide, Plastic Dual Inline Package (PDIP)
8S1	8-Lead, 0.150" Wide, Plastic Gull Wing Small Outline (JEDEC SOIC)
14S	14-Lead, 0.150" Wide, Plastic Gull Wing Small Outline (SOIC)
8T	8-Lead, 0.170" Wide, Thin Shrink Small Outline Package (TSSOP)

Options

Blank	Standard Operation (4.5V to 5.5V)
-2.7	Low-Voltage (2.7V to 5.5V)
-2.5	Low-Voltage (2.5V to 5.5V)
-1.8	Low-Voltage (1.8V to 5.5V)

AT24C04A Ordering Information

t _{WR} (max) (ms)	I _{CC} (max) (μA)	I _{SB} (max) (μA)	f _{MAX} (kHz)	Ordering Code	Package	Operation Range
10	3000	18	400	AT24C04A-10PC AT24C04AN-10SC AT24C04A-10SC AT24C04A-10TC	8P3 8S1 14S 8T	Commercial (0°C to 70°C)
	3000	18	400	AT24C04A-10PI AT24C04AN-10SI AT24C04A-10SI AT24C04A-10TI	8P3 8S1 14S 8T	Industrial (-40°C to 85°C)
10	1500	4	100	AT24C04A-10PC-2.7 AT24C04AN-10SC-2.7 AT24C04A-10SC-2.7 AT24C04A-10TC	8P3 8S1 14S 8T	Commercial (0°C to 70°C)
	1500	4	100	AT24C04A-10PI-2.7 AT24C04AN-10SI-2.7 AT24C04A-10SI-2.7 AT24C04A-10TI-2.7	8P3 8S1 14S 8T	Industrial (-40°C to 85°C)
10	1000	4	100	AT24C04A-10PC-2.5 AT24C04AN-10SC-2.5 AT24C04A-10SC-2.5 AT24C04A-10TC-2.5	8P3 8S1 14S 8T	Commercial (0°C to 70°C)
	1000	4	100	AT24C04A-10PI-2.5 AT24C04AN-10SI-2.5 AT24C04A-10SI-2.5 AT24C04A-10TI-2.5	8P3 8S1 14S 8T	Industrial (-40°C to 85°C)
10	800	3	100	AT24C04A-10PC-1.8 AT24C04AN-10SC-1.8 AT24C04A-10SC-1.8 AT24C04A-10TC-1.8	8P3 8S1 14S 8T	Commercial (0°C to 70°C)
	800	3	100	AT24C04A-10PI-1.8 AT24C04AN-10SI-1.8 AT24C04A-10SI-1.8 AT24C04A-10TI-1.8	8P3 8S1 14S 8T	Industrial (-40°C to 85°C)

2

Package Type	
8P3	8-Lead, 0.300" Wide, Plastic Dual Inline Package (PDIP)
8S1	8-Lead, 0.150" Wide, Plastic Gull Wing Small Outline (JEDEC SOIC)
14S	14-Lead, 0.150" Wide, Plastic Gull Wing Small Outline (SOIC)
8T	8-Lead, 0.170" Wide, Thin Shrink Small Outline Package (TSSOP)
Options	
Blank	Standard Operation (4.5V to 5.5V)
-2.7	Low-Voltage (2.7V to 5.5V)
-2.5	Low-Voltage (2.5V to 5.5V)
-1.8	Low-Voltage (1.8V to 5.5V)





AT24C08A Ordering Information

t_{WR} (max) (ms)	I_{CC} (max) (μ A)	I_{SB} (max) (μ A)	f_{MAX} (kHz)	Ordering Code	Package	Operation Range
10	3000	18	400	AT24C08A-10PC AT24C08AN-10SC AT24C08A-10SC AT24C08A-10TC	8P3 8S1 14S 8T	Commercial (0°C to 70°C)
	3000	18	400	AT24C08A-10PI AT24C08AN-10SI AT24C08A-10SI AT24C08A-10TI	8P3 8S1 14S 8T	Industrial (-40°C to 85°C)
10	1500	4	100	AT24C08A-10PC-2.7 AT24C08AN-10SC-2.7 AT24C08A-10SC-2.7 AT24C08A-10TC-2.7	8P3 8S1 14S 8T	Commercial (0°C to 70°C)
	1500	4	100	AT24C08A-10PI-2.7 AT24C08AN-10SI-2.7 AT24C08A-10SI-2.7 AT24C08A-10TI-2.7	8P3 8S1 14S 8T	Industrial (-40°C to 85°C)
10	1000	4	100	AT24C08A-10PC-2.5 AT24C08AN-10SC-2.5 AT24C08A-10SC-2.5 AT24C08A-10TC-2.5	8P3 8S1 14S 8T	Commercial (0°C to 70°C)
	1000	4	100	AT24C08A-10PI-2.5 AT24C08AN-10SI-2.5 AT24C08A-10SI-2.5 AT24C08A-10TI-2.5	8P3 8S1 14S 8T	Industrial (-40°C to 85°C)
10	800	3	100	AT24C08A-10PC-1.8 AT24C08AN-10SC-1.8 AT24C08A-10SC-1.8 AT24C08A-10TC-1.8	8P3 8S1 14S 8T	Commercial (0°C to 70°C)
	800	3	100	AT24C08A-10PI-1.8 AT24C08AN-10SI-1.8 AT24C08A-10SI-1.8 AT24C08A-10TI-1.8	8P3 8S1 14S 8T	Industrial (-40°C to 85°C)

Package Type	
8P3	8-Lead, 0.300" Wide, Plastic Dual Inline Package (PDIP)
8S1	8-Lead, 0.150" Wide, Plastic Gull Wing Small Outline (JEDEC SOIC)
14S	14-Lead, 0.150" Wide, Plastic Gull Wing Small Outline (SOIC)
8T	8-Lead, 0.170" Wide, Thin Shrink Small Outline Package (TSSOP)
Options	
Blank	Standard Operation (4.5V to 5.5V)
-2.7	Low-Voltage (2.7V to 5.5V)
-2.5	Low-Voltage (2.5V to 5.5V)
-1.8	Low-Voltage (1.8V to 5.5V)