

Surface Mount Transient Voltage Suppressor

FEATURES

- Low profile package
- Ideal for automated placement
- Glass passivated junction
- Built-in strain relief
- Excellent clamping capability
- Fast response time: Typically less than 1.0ps from 0 volt to BV min
- Typical IR less than 1µA above 10V
- Moisture sensitivity level: level 1, per J-STD-020
- Compliant to RoHS Directive 2011/65/EU and in accordance to WEEE 2002/96/EC
- Halogen-free according to IEC 61249-2-21 definition



DO-214AB (SMC)

MECHANICAL DATA

Case: DO-214AB (SMC)

Molding compound, UL flammability classification rating 94V-0

Base P/N with suffix "G" on packing code - green compound (halogen-free)

Base P/N with prefix "H" on packing code - AEC-Q101 qualified

Terminal: Matte tin plated leads, solderable per JESD22-B102

Meet JESD 201 class 1A whisker test

with prefix "H" on packing code meet JESD 201 class 2 whisker test

Polarity: Indicated by cathode band

Weight: 0.21 g (approximately)

MAXIMUM RATINGS AND ELECTRICAL CHARACTERISTICS (T _A =25°C unless otherwise noted)			
PARAMETER	SYMBOL	VALUE	UNIT
Peak power dissipation at T _A =25°C, tp=1ms (Note 1)	P _{PK}	1500	Watts
Steady state power dissipation	P _D	6.5	Watts
Peak forward surge current, 8.3 ms single half sine-wave superimposed on rated load	I _{FSM}	200	A
Maximum instantaneous forward voltage at 50 A for Unidirectional only (Note 2)	V _F	3.5 / 5.0	Volts
Typical thermal resistance	R _{θJC} R _{θJA}	15 50	°C/W
Operating junction temperature range	T _J	- 55 to +150	°C
Storage temperature range	T _{STG}	- 55 to +150	°C

Note 1: Non-repetitive Current Pulse Per Fig. 3 and Derated above T_A=25°C Per Fig. 2

Note 2: V_F=3.5V on 1.5SMC6.8 thru 1.5SMC91 Devices and V_F=5.0V on 1.5SMC100 thru 1.5SMC200 Devices

Devices for Bipolar Applications

1. For Bidirectional Use C or CA Suffix for Types 1.5SMC6.8 through Types 1.5SMC200A
2. Electrical Characteristics Apply in Both Directions

ORDERING INFORMATION					
PART NO.	AEC-Q101 QUALIFIED	PACKING CODE	GREEN COMPOUND CODE	PACKAGE	PACKING
1.5SMCxxxx (Note 1)	Prefix "H"	R7	Suffix "G"	SMC	850 / 7" Plastic reel
		R6		SMC	3,000 / 13" Paper reel
		M6		SMC	3,000 / 13" Plastic reel

Note 1: "xxxx" defines voltage from 6.8V (1.5SMC6.8) to 200V (1.5SMC200A)

EXAMPLE					
PREFERRED P/N	PART NO.	AEC-Q101 QUALIFIED	PACKING CODE	GREEN COMPOUND	DESCRIPTION
1.5SMC200A R7	1.5SMC200A		R7		
1.5SMC200A R7G	1.5SMC200A		R7	G	Green compound
1.5SMC200AHR7	1.5SMC200A	H	R7		AEC-Q101 qualified

RATINGS AND CHARACTERISTICS CURVES (TA=25°C unless otherwise noted)

FIG. 1 PEAK PULSE POWER RATING CURVE

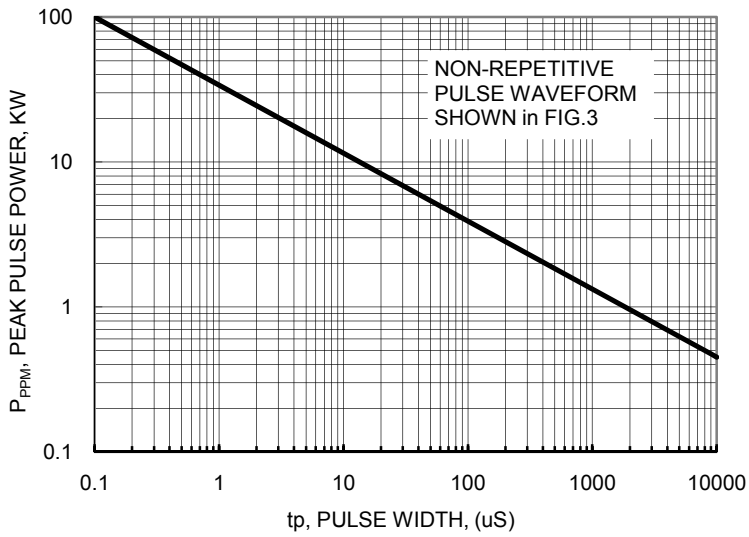

FIG. 2 PULSE DERATING CURVE

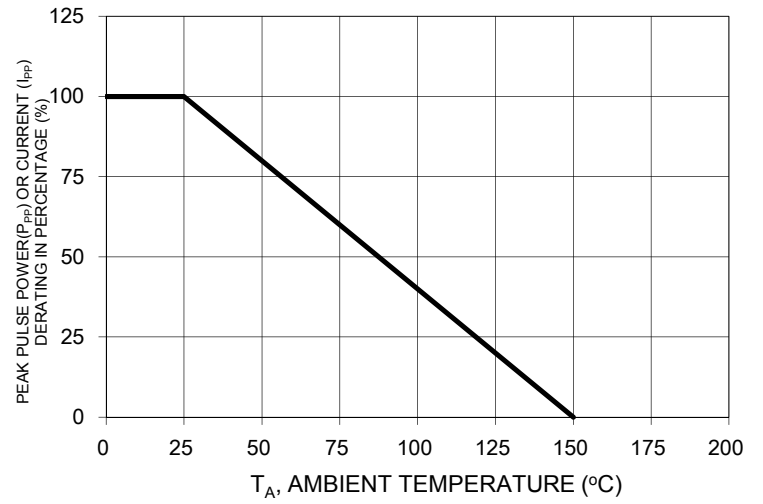

FIG. 3 CLAMPING POWER PULSE WAVEFORM

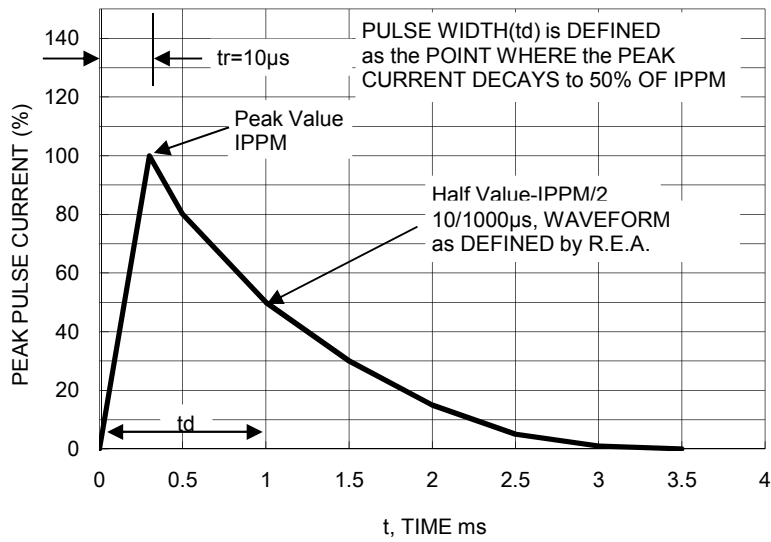

FIG. 4 MAXIMUM NON-REPETITIVE FORWARD SURGE CURRENT UNIDIRECTIONAL ONLY

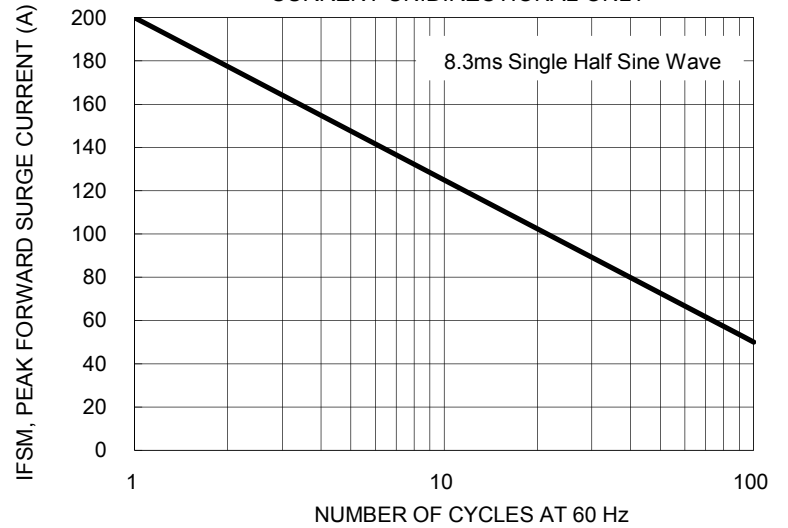
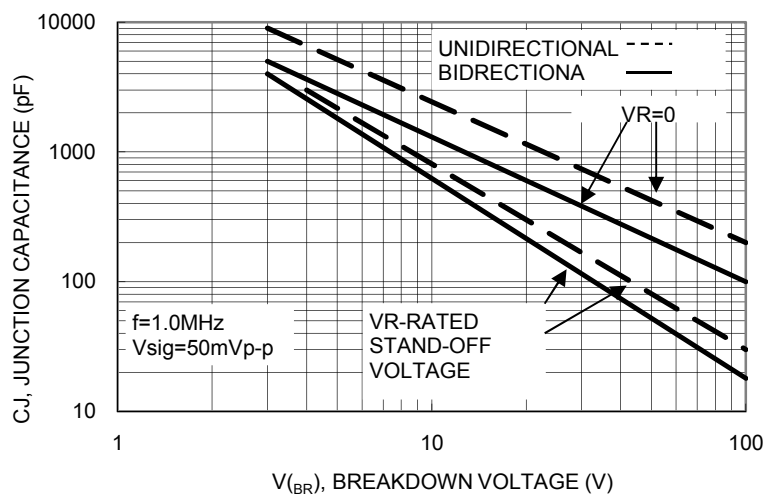

FIG. 5 TYPICAL JUNCTION CAPACITANCE



GENERAL PART NUMBER	Device Marking Code	Breakdown Voltage V_{BR} (V) (Note 1)		Test Current I_T (mA)	Stand-Off Voltage V_{WM} (V)	Maximum Reverse Leakage @ V_{WM} I_D (uA)	Maximum Peak Pulse Current I_{PPM} (A) (Note 2)	Maximum Clamping Voltage @ I_{PPM} V_c (V)	Maximum Temperature Coefficient of V_{BR} (%/°C)
		Min	Max						
1.5SMC6.8	DDJ	6.12	7.48	10	5.50	1000	145	10.8	0.057
1.5SMC6.8A	DEJ	6.46	7.14	10	5.80	1000	150	10.5	0.057
1.5SMC7.5	DFJ	6.75	8.25	10	6.05	500	134	11.7	0.061
1.5SMC7.5A	DGJ	7.13	7.88	10	6.40	500	139	11.3	0.061
1.5SMC8.2	DHJ	7.38	9.02	10	6.63	200	126	12.5	0.065
1.5SMC8.2A	DKJ	7.79	8.61	10	7.02	200	130	12.1	0.065
1.5SMC9.1	DLJ	8.19	10.00	1.0	7.37	50	114	13.8	0.068
1.5SMC9.1A	DMJ	8.65	9.55	1.0	7.78	50	117	13.4	0.068
1.5SMC10	DNJ	9.00	11.00	1.0	8.10	10	105	15.0	0.073
1.5SMC10A	DPJ	9.50	10.5	1.0	8.55	10	108	14.5	0.073
1.5SMC11	DQJ	9.90	12.1	1.0	8.92	1	97	16.2	0.075
1.5SMC11A	DRJ	10.5	11.6	1.0	9.40	1	100	15.6	0.075
1.5SMC12	DSJ	10.8	13.2	1.0	9.72	1	91	17.3	0.078
1.5SMC12A	DTJ	11.4	12.6	1.0	10.2	1	94	16.7	0.078
1.5SMC13	DUJ	11.7	14.3	1.0	10.5	1	82	19.0	0.081
1.5SMC13A	DVJ	12.4	13.7	1.0	11.1	1	86	18.2	0.081
1.5SMC15	DWJ	13.5	16.5	1.0	12.1	1	71	22.0	0.084
1.5SMC15A	DXJ	14.3	15.8	1.0	12.8	1	74	21.2	0.084
1.5SMC16	DYJ	14.4	17.6	1.0	12.9	1	67	23.5	0.086
1.5SMC16A	DZJ	15.2	16.8	1.0	13.6	1	70	22.5	0.086
1.5SMC18	EDJ	16.2	19.8	1.0	14.5	1	59	26.5	0.088
1.5SMC18A	EEJ	17.1	18.9	1.0	15.3	1	60	25.5	0.088
1.5SMC20	EFJ	18.0	22.0	1.0	16.2	1	54	29.1	0.090
1.5SMC20A	EGJ	19.0	21.0	1.0	17.1	1	56	27.7	0.090
1.5SMC22	EHJ	19.8	24.2	1.0	17.8	1	49	31.9	0.092
1.5SMC22A	EKJ	20.9	23.1	1.0	18.8	1	51	30.6	0.092
1.5SMC24	ELJ	21.6	26.4	1.0	19.4	1	45	34.7	0.094
1.5SMC24A	EMJ	22.8	25.2	1.0	20.5	1	47	33.2	0.094
1.5SMC27	ENJ	24.3	29.7	1.0	21.8	1	40	39.1	0.096
1.5SMC27A	EPJ	25.7	28.4	1.0	23.1	1	42	37.5	0.096
1.5SMC30	EQJ	27.0	33.0	1.0	24.3	1	36	43.5	0.097
1.5SMC30A	ERJ	28.5	31.5	1.0	25.6	1	38	41.4	0.097
1.5SMC33	ESJ	29.7	36.3	1.0	26.8	1	33	47.7	0.098
1.5SMC33A	ETJ	31.4	34.7	1.0	28.2	1	34	45.7	0.098
1.5SMC36	EUJ	32.4	39.6	1.0	29.1	1	30	52.0	0.099
1.5SMC36A	EVJ	34.2	37.8	1.0	30.8	1	31	49.9	0.099
1.5SMC39	EWJ	35.1	42.9	1.0	31.6	1	27	56.4	0.100
1.5SMC39A	EXJ	37.1	41.0	1.0	33.3	1	29	53.9	0.100
1.5SMC43	EYJ	38.7	47.3	1.0	34.8	1	25	61.9	0.101
1.5SMC43A	EZJ	40.9	45.2	1.0	36.8	1	26	59.3	0.101
1.5SMC47	FDJ	42.3	51.7	1.0	38.1	1	23	67.8	0.101
1.5SMC47A	FEJ	44.7	49.4	1.0	40.2	1	24	64.8	0.101
1.5SMC51	FFJ	45.9	56.1	1.0	41.3	1	21	73.5	0.102
1.5SMC51A	FGJ	48.5	53.6	1.0	43.6	1	22	70.1	0.102
1.5SMC56	FHJ	50.4	61.6	1.0	45.4	1	19	80.5	0.103
1.5SMC56A	FKJ	53.2	58.8	1.0	47.8	1	20	77.0	0.103

GENERAL PART NUMBER	Device Marking Code	Breakdown Voltage V_{BR} (V) (Note 1)		Test Current I_T (mA)	Stand-Off Voltage V_{WM} (V)	Maximum Reverse Leakage @ V_{WM} I_D (uA)	Maximum Peak Pulse Current I_{PPM} (A) (Note 2)	Maximum Clamping Voltage @ I_{PPM} V_c (V)	Maximum Temperature Coefficient of V_{BR} (%/°C)
		Min	Max						
1.5SMC62	FLJ	55.8	68.2	1.0	50.2	1	17	89.0	0.104
1.5SMC62A	FMJ	58.9	65.1	1.0	53.0	1	18	85.0	0.104
1.5SMC68	FNJ	61.2	74.8	1.0	55.1	1	16	98.0	0.104
1.5SMC68A	FPJ	64.6	71.4	1.0	58.1	1	17	92.0	0.104
1.5SMC75	FQJ	67.5	82.5	1.0	60.7	1	14	108	0.105
1.5SMC75A	FRJ	71.3	78.8	1.0	64.1	1	15	103	0.105
1.5SMC82	FSJ	73.8	90.2	1.0	66.4	1	13	118	0.105
1.5SMC82A	FTJ	77.9	86.1	1.0	70.1	1	13.9	113	0.105
1.5SMC91	FUJ	81.9	100	1.0	73.7	1	12	131	0.106
1.5SMC91A	FVJ	86.5	95.5	1.0	77.8	1	12.6	125	0.106
1.5SMC100	FWJ	90	110	1.0	81.0	1	10.9	144	0.106
1.5SMC100A	FXJ	95	105	1.0	85.5	1	11.4	137	0.106
1.5SMC110	FYJ	99	121	1.0	89.2	1	9.9	158	0.107
1.5SMC110A	FZJ	105	116	1.0	94.0	1	10.3	152	0.107
1.5SMC120	GDJ	108	132	1.0	97.2	1	9.1	173	0.107
1.5SMC120A	GEJ	114	126	1.0	102.0	1	9.5	165	0.107
1.5SMC130	GFJ	117	143	1.0	105.0	1	8.4	187	0.107
1.5SMC130A	GGJ	124	137	1.0	111.0	1	8.7	179	0.107
1.5SMC150	GHJ	135	165	1.0	121.0	1	7.3	215	0.108
1.5SMC150A	GKJ	143	158	1.0	128.0	1	7.6	207	0.108
1.5SMC160	GLJ	144	176	1.0	130.0	1	6.8	230	0.108
1.5SMC160A	GMJ	152	168	1.0	136.0	1	7.1	219	0.108
1.5SMC170	GNJ	153	187	1.0	138.0	1	6.4	244	0.108
1.5SMC170A	GPJ	162	179	1.0	145.0	1	6.7	234	0.108
1.5SMC180	GQJ	162	198	1.0	146.0	1	6.1	258	0.108
1.5SMC180A	GRJ	171	189	1.0	154.0	1	6.4	246	0.108
1.5SMC200	GSJ	180	220	1.0	162.0	1	5.4	287	0.108
1.5SMC200A	GTJ	190	210	1.0	171.0	1	5.7	274	0.108

Notes:

1. V_{BR} measure after I_T applied for 300 μ s, I_T =square wave pulse or equivalent.
2. Surge current waveform per Figure. 3 and derate per Figure. 2.
3. For bipolar types having V_{WM} of 10 volts and under, the I_D limit is doubled.
4. For bidirectional use C or CA suffix for types 1.5SMC6.8 through 1.5SMC200A
5. All terms and symbols are consistent with ANSI/IEEE C62.35.

PACKAGE OUTLINE DIMENSIONS

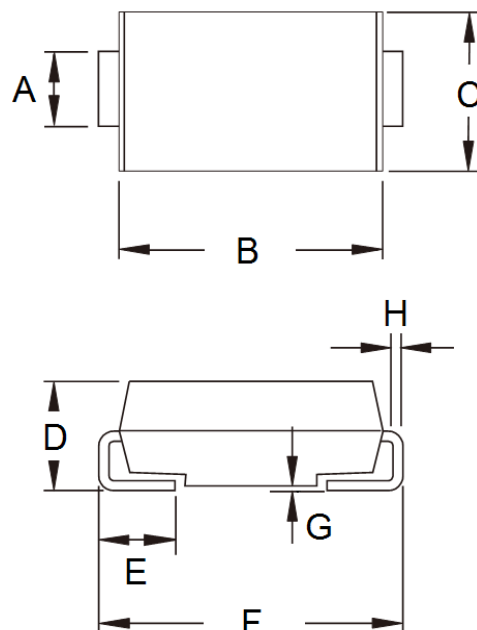

DIM.	Unit (mm)		Unit (inch)	
	Min	Max	Min	Max
A	2.90	3.20	0.114	0.126
B	6.60	7.11	0.260	0.280
C	5.59	6.22	0.220	0.245
D	2.00	2.62	0.079	0.103
E	1.00	1.60	0.039	0.063
F	7.75	8.13	0.305	0.320
G	0.10	0.20	0.004	0.008
H	0.15	0.31	0.006	0.012

SUGGESTED PAD LAYOUT

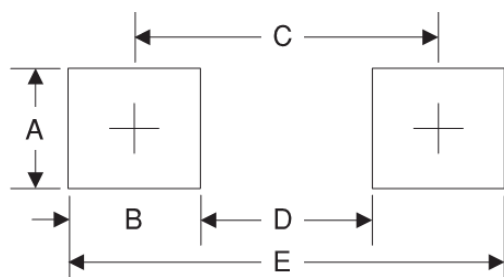

Symbol	Unit (mm)	Unit (inch)
A	3.3	0.130
B	2.5	0.098
C	6.8	0.268
D	4.4	0.173
E	9.4	0.370

MARKING DIAGRAM



- P/N = Specific Device Code
- G = Green Compound
- YW = Date Code
- F = Factory Code

Notice

Specifications of the products displayed herein are subject to change without notice. TSC or anyone on its behalf, assumes no responsibility or liability for any errors inaccuracies.

Information contained herein is intended to provide a product description only. No license, express or implied, to any intellectual property rights is granted by this document. Except as provided in TSC's terms and conditions of sale for such products, TSC assumes no liability whatsoever, and disclaims any express or implied warranty, relating to sale and/or use of TSC products including liability or warranties relating to fitness for a particular purpose, merchantability, or infringement of any patent, copyright, or other intellectual property right.

The products shown herein are not designed for use in medical, life-saving, or life-sustaining applications. Customers using or selling these products for use in such applications do so at their own risk and agree to fully indemnify TSC for any damages resulting from such improper use or sale.