

Type A Vertical Male Feed-To for Backplanes

Series 8071

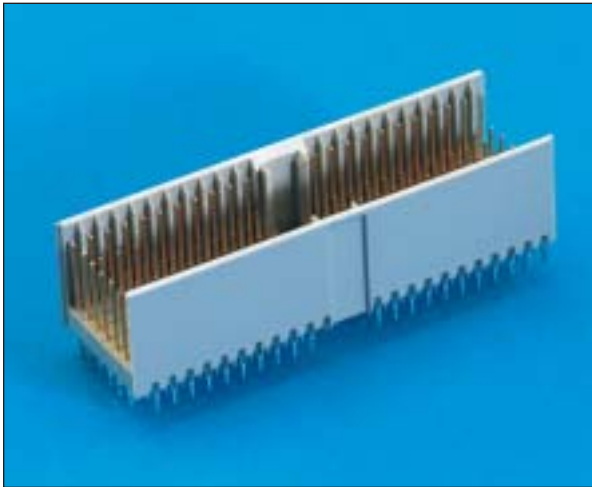

- 110 signal contacts and up to 44 ground shield contacts in 5 or 5+2 rows of 25 positions
- Center cavity for polarization (uses 3 positions)
- Prealignment guides
- See page 56 for keying options
- Designed for gas tight press-fit installation
- Twelve different contact styles are available for customizing connector to exact specifications (see page 64)

17 8071 110 506 XXX = Type A 110 signal contacts, no ground contacts L1
17 8071 110 510 XXX = Type A 110 signal contacts, no ground contacts L2
17 8071 154 509 XXX = Type A 110 signal contacts and 44 ground contacts L1,3
17 8071 154 512 XXX = Type A 110 signal contacts and 44 ground contacts L2,3

XXX =

Plating Code	Contact Area	Press-fit Area	Under Coat
833	0.1µm min. Au.65µm Pd/Ni	1.5-3.0µm Solder	Nickel 1.2-3.0µm
863	0.76µm min. Au	1.5-3.0µm Solder	Nickel 1.2-3.0µm

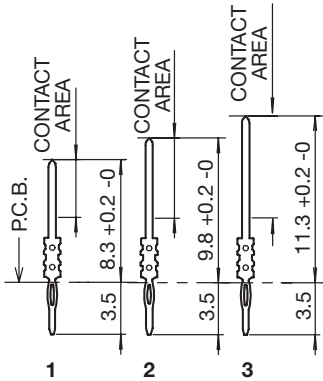
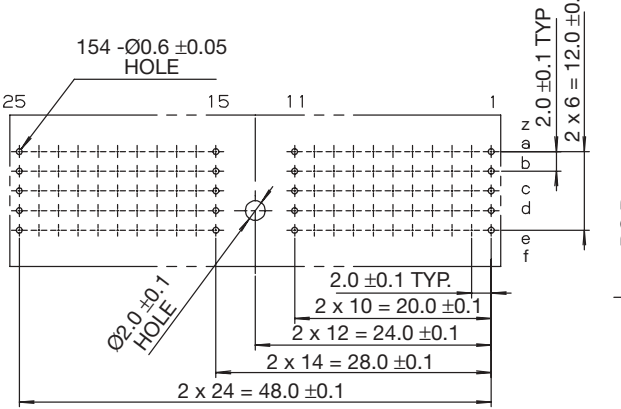
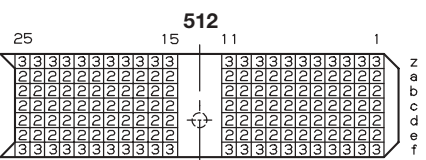
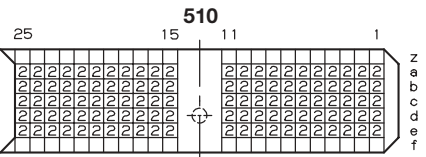
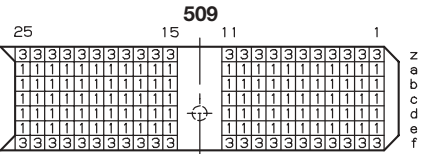
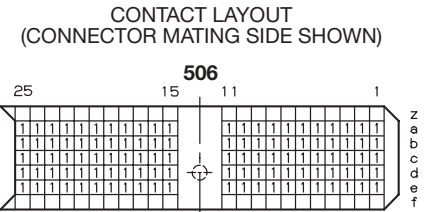
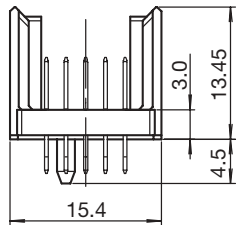
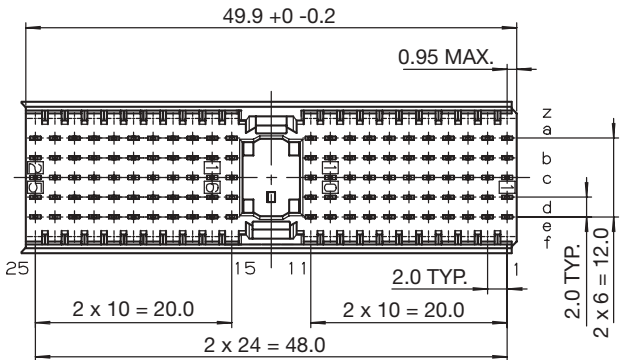

RECOMMENDED P.C. BOARD LAYOUT (COMPONENT SIDE)

CONTACT DETAIL