

T-41-21

SLH-34 Series of T1 Super-Bright LED Lamps

Description

The SLH-34 Series of Super-Bright T1 LED lamps provides extremely high luminous intensity without high current requirements. Super-Bright LED lamps are ideal for applications where brightness is a high priority concern, such as environments with high ambient light conditions. In addition, the small T1 size allows them to be used in applications where space is at a premium. These 3.1 mm diameter lamps feature GaP as the radiating substrate material. Seven emitting colors and a choice of three lenses provide a total of 17 Super-Bright LED lamps in the T1 size.

Features:

- Extremely high luminous intensity (minimums to 90 mcd)
- Low current requirements
- Seven emitting colors: red, high-efficiency red, orange, yellow, and three shades of green
- Choice of three lenses: colored diffused, colored transparent, and clear
- High reliability construction
- Shorter cathode lead for easier identification
- IC compatible
- No current vs. luminous intensity saturation
- 3.1 mm diameter package

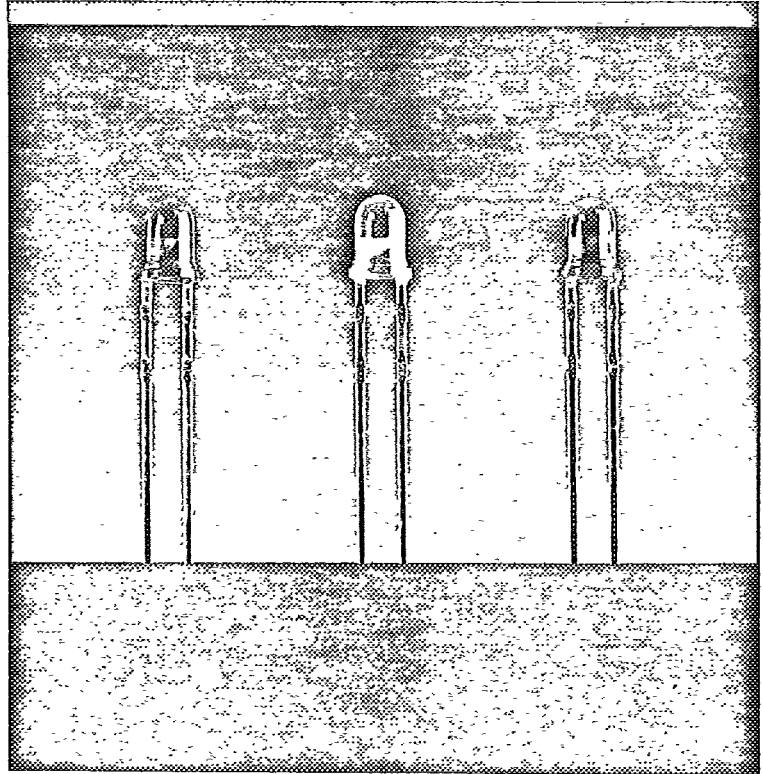

Part Descriptions

Lens	Emitting Color				
	Red	Hi-Eff. Red	Orange	Yellow	Green
Colored Diffused	SLH-34VR3	SLH-34UR3	SLH-34DU3	SLH-34YY3	SLH-34GG3/MG3
Colored Transparent	SLH-34VC3	SLH-34URC3	SLH-34DC3	SLH-34YC3	SLH-34PC3
Clear	SLH-34VT3	SLH-34UT3	SLH-34DT3	SLH-34YT3	SLH-34MT3/PT3

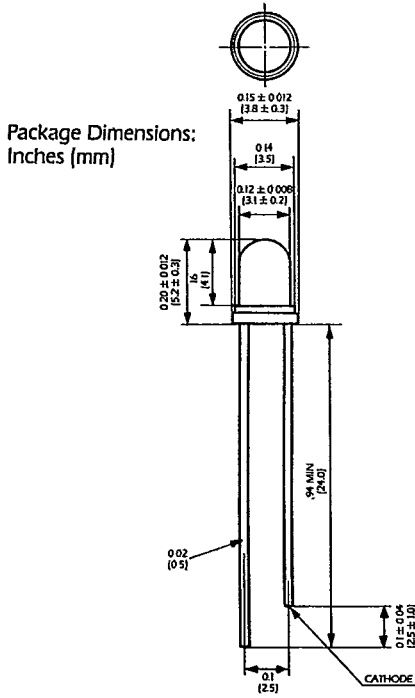

LUMINOUS INTENSITY I_V
Test Conditions: $I_F = 20\text{mA}$

Color	Type	Min	Typ	Unit
Red	SLH-34 VR3	36	80	mcd
	SLH-34 VC3	56	160	mcd
	SLH-34 VT3	90	200	mcd
High Efficiency Red	SLH-34 UR3	36	80	mcd
	SLH-34 UC3	56	160	mcd
	SLH-34 UT3	90	200	mcd
Orange	SLH-34 DU3	36	80	mcd
	SLH-34 DC3	56	160	mcd
	SLH-34 DT3	90	200	mcd
Yellow	SLH-34 YY3	36	80	mcd
	SLH34 YC3	56	160	mcd
	SLH-34 YT3	90	200	mcd
Yellow Green	SLH-34 GG3	36	80	mcd
Green	SLH-34 MG3	36	80	mcd
	SLH-34 MT3	90	200	mcd
Pure Green	SLH-34 PC3	36	80	mcd
	SLH-34 PT3	56	160	mcd

ABSOLUTE MAXIMUM RATINGS ($T_a = 25^\circ\text{C}$)

Parameter	Symbol	Red	High-Eff. Red	Orange	Yellow	Green	Unit	
		SLH-34 VR3 SLH-34 VC3 SLH-34 VT3	SLH-34 UR3 SLH-34 UC3 SLH-34 UT3	SLH-34 DU3 SLH-34 DC3 SLH-34 DT3	SLH-34 YY3 SLH-34 YC3 SLH-34 YT3	SLH-34 GG3 SLH-34 MG3 SLH-34 PC3 SLH-34 MT3 SLH-34 PT3		
Power Dissipation	P_d	75	75	75	75	75	mW	
Forward Current	I_F	25	25	25	25	25	mA	
Peak Forward Current	I_{FP}	60	60	60	60	60	mA	
Reverse Voltage	V_R	3	3	3	3	3	V	
Operating Temperature	T_{opr}	-55 to 100						$^\circ\text{C}$
Storage Temperature	T_{stg}	-55 to 100						$^\circ\text{C}$
Lead Soldering Temperature	—	260 $^\circ\text{C}$ (max 5 sec; min .063"/1.6mm from body)						—

ELECTRO/OPTICAL CHARACTERISTICS ($T_a = 25^\circ\text{C}$)

Parameter	Symbol	Condition	Red			Hi-Eff. Red			Orange			Yellow			Green			Unit
			Min	Typ	Max	Min	Typ	Max	Min	Typ	Max	Min	Typ	Max	Min	Typ	Max	
Forward Voltage	V_F	$I_F = 20\text{mA}$	-	2.1	3.0	-	2.1	3.0	-	2.1	3.0	-	2.2	3.0	-	2.1	3.0	V
Reverse Current	I_R	$V_R = 3\text{V}$	-	-	10	-	-	10	-	-	10	-	-	10	-	-	10	μA
Peak Wavelength	λ_p	$I_F = 20\text{mA}$	-	650	-	-	635	-	-	610	-	-	585	-	-	*	-	nm
Spectral Line Half Width	$\Delta\lambda$	$I_F = 20\text{mA}$	-	40	-	-	40	-	-	40	-	-	40	-	-	40	-	nm
Included Angle Between Half		Diffused Type	-	50	-	-	50	-	-	50	-	-	50	-	-	50	-	deg
Luminous Intensity Points	$20\frac{1}{2}$	Trans-parent Type	-	30	-	-	30	-	-	30	-	-	30	-	-	30	-	deg

*Peak wavelength for SLH-34GG3 = 565 nm.
Peak wavelength for SLH-34MG3/MT3 = 563 nm.
Peak wavelength for SLH-34PC3/PT3 = 555 nm.

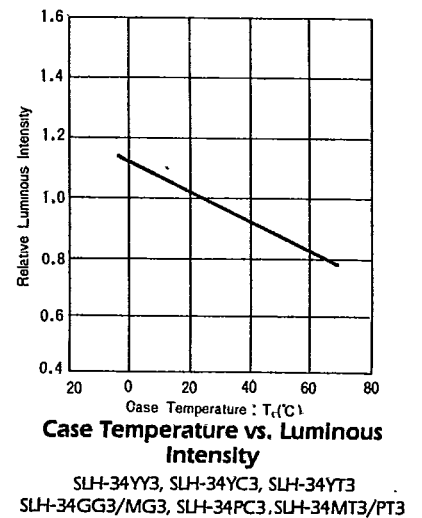
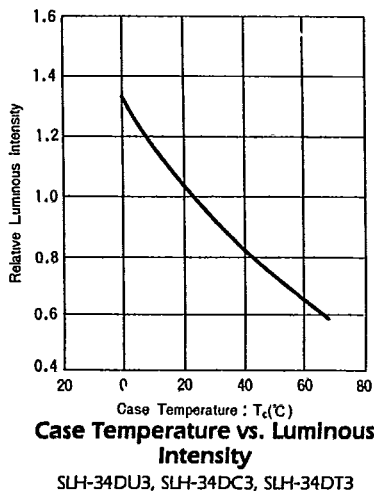
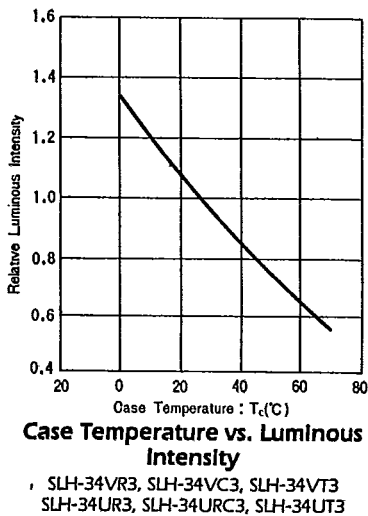
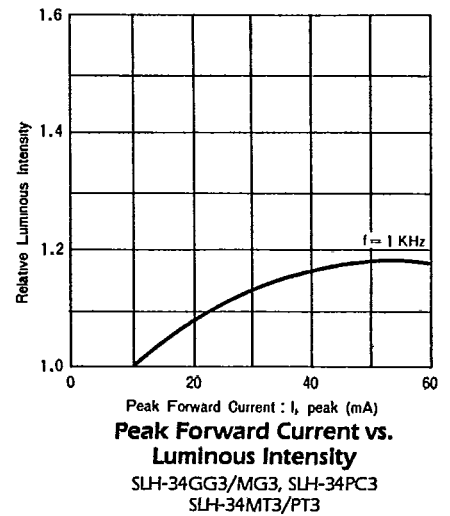
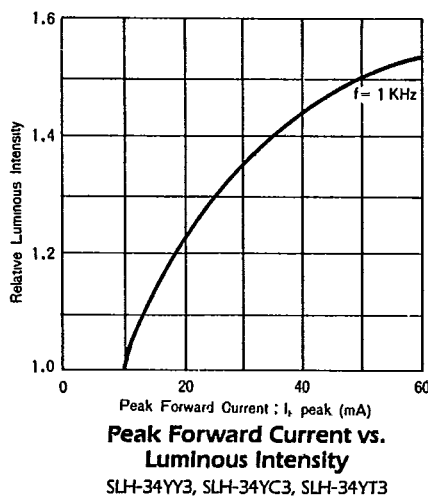
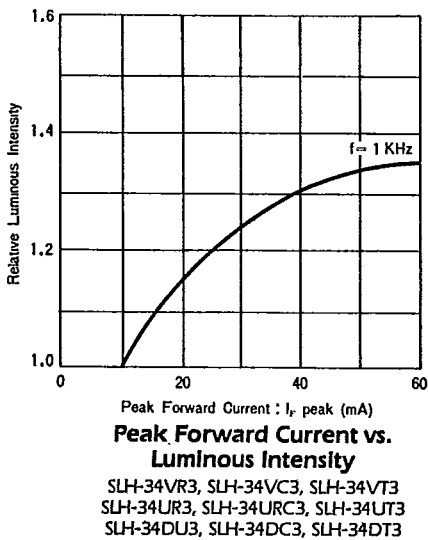
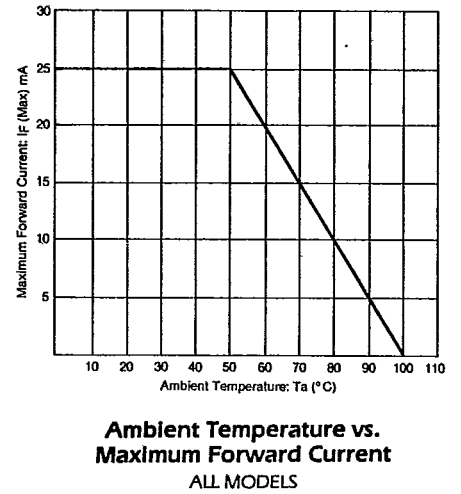
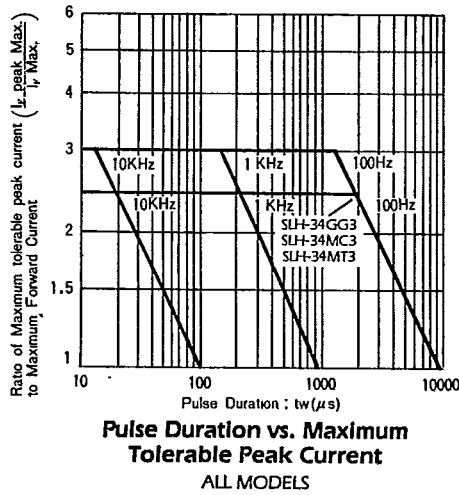
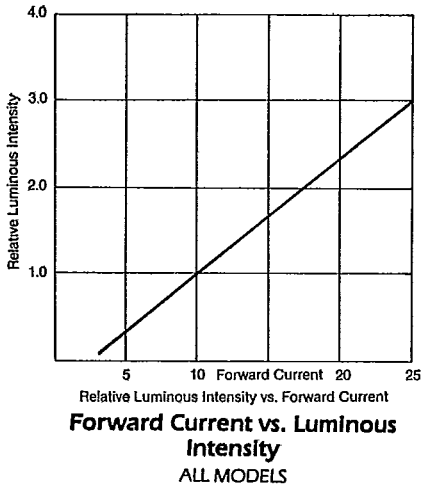

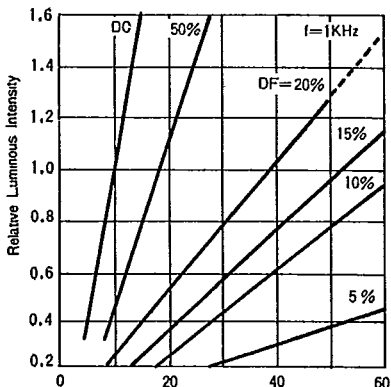

Peak Forward Current vs. Luminous Intensity

SLH-34VR3, SLH-34VC3, SLH-34VT3
 SLH-34UR3, SLH-34URC3, SLH-34UT3
 SLH-34DU3, SLH-34DC3, SLH-34DT3

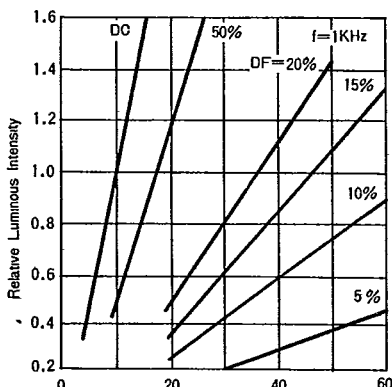

Peak Forward Current vs. Luminous Intensity

SLH-34YY3, SLH-34YC3, SLH-34YT3

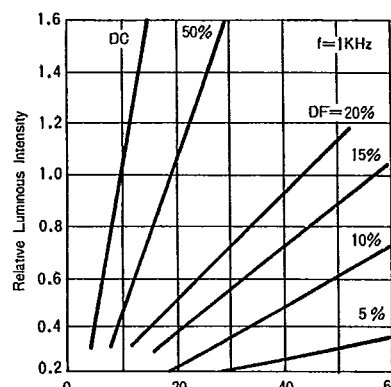

Peak Forward Current vs. Luminous Intensity

SLH-34GG3/MG3, SLH-34PC3
 SLH-34MT3/PT3

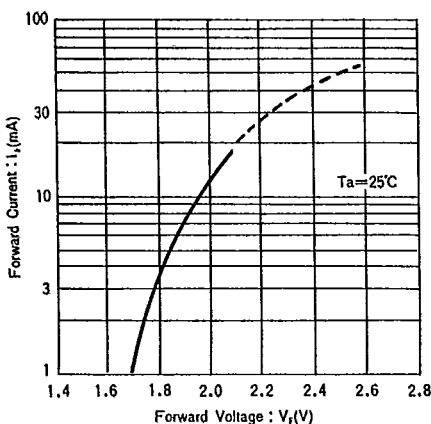

Forward Voltage vs. Forward Current

SLH-34VR3, SLH-34VC3, SLH-34VT3
 SLH-34UR3, SLH-34URC3, SLH-34UT3

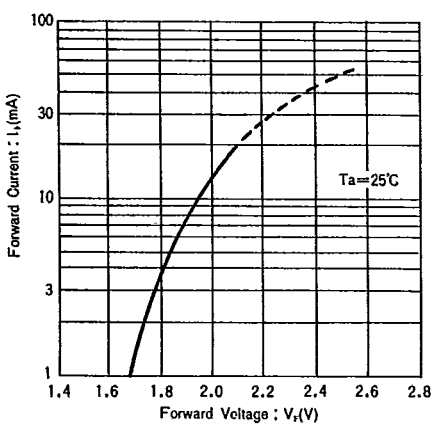

Forward Voltage vs. Forward Current

SLH-34DU3, SLH-34DC3, SLH-34DT3

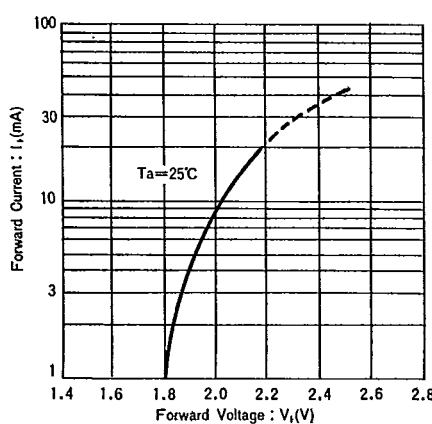

Forward Voltage vs. Forward Current

SLH-34YY3, SLH-34YC3, SLH-34YT3

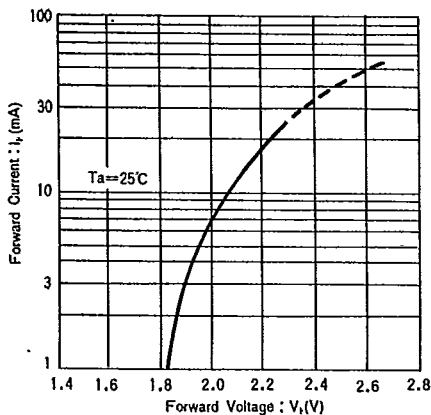

Forward Voltage vs. Forward Current

SLH-34GG3/MG3, SLH-34PC3
 SLH-34MT3/PT3

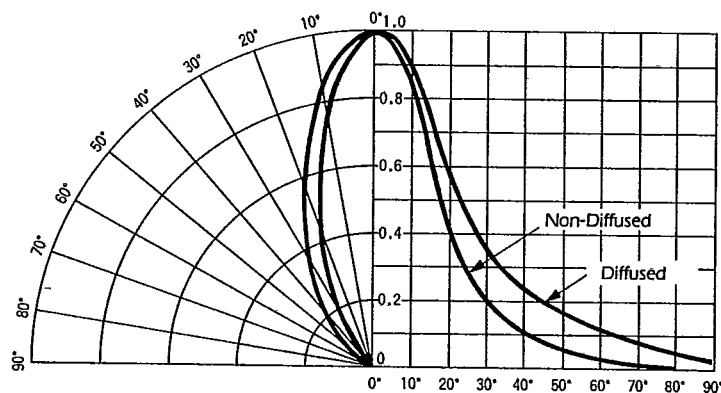

Directional Pattern
 ALL MODELS