

## Surface-Mount Ultrafast Plastic Rectifier

**SMC (DO-214AB)**

 Cathode  Anode

### LINKS TO ADDITIONAL RESOURCES

[3D Models](#)

PRIMARY CHARACTERISTICS	
$I_{F(AV)}$	3.0 A
$V_{RRM}$	400 V, 600 V
$I_{FSM}$	125 A
$t_{rr}$	50 ns
$V_F$	1.05 V
$T_J$ max.	175 °C
Package	SMC (DO-214AB)
Circuit configuration	Single

### FEATURES

- Glass passivated pellet chip junction
- Ideal for automated placement
- Ultrafast reverse recovery time
- Low switching losses, high efficiency
- High forward surge capability
- Meets MSL level 1, per J-STD-020, LF maximum peak of 260 °C
- AEC-Q101 qualified available
  - Automotive ordering code: base P/NHE3 or P/NHM3
- Material categorization: for definitions of compliance please see [www.vishay.com/doc?99912](http://www.vishay.com/doc?99912)



### TYPICAL APPLICATIONS

For use in high frequency rectification and freewheeling application in switching mode converters and inverters for consumer, computer, automotive and telecommunication.

### MECHANICAL DATA

**Case:** SMC (DO-214AB)

Molding compound meets UL 94 V-0 flammability rating  
 Base P/N-E3 - RoHS-compliant, commercial grade  
 Base P/N-M3 - halogen-free, RoHS-compliant, commercial grade

Base P/NHE3\_X - RoHS-compliant and AEC-Q101 qualified  
 Base P/NHM3\_X - halogen-free, RoHS-compliant, and AEC-Q101 qualified  
 (“\_X” denotes revision code e.g. A, B, .....) )

**Terminals:** matte tin plated leads, solderable per J-STD-002 and JESD 22-B102  
 E3 suffix meets JESD 201 class 2 whisker test, HE3 suffix meets JESD 201 class 2 whisker test

**Polarity:** color band denotes cathode end

MAXIMUM RATINGS ( $T_A = 25\text{ °C}$ unless otherwise noted)				
PARAMETER	SYMBOL	MURS340	MURS360	UNIT
Device marking code		MG	MJ	
Maximum repetitive peak reverse voltage	$V_{RRM}$	400	600	V
Working peak reverse voltage	$V_{RWM}$	400	600	V
Maximum DC blocking voltage	$V_{DC}$	400	600	V
Maximum average forward rectified current at: (fig. 1)	$I_{F(AV)}$	$T_L = 130\text{ °C}$		A
		$T_L = 115\text{ °C}$		
Peak forward surge current 8.3 ms single half sine-wave superimposed on rated load	$I_{FSM}$	125		A
Operating junction and storage temperature range	$T_J, T_{STG}$	-65 to +175		°C

**ELECTRICAL CHARACTERISTICS** ( $T_A = 25\text{ }^\circ\text{C}$  unless otherwise noted)

PARAMETER	TEST CONDITIONS	SYMBOL	MURS340	MURS360	UNIT
Maximum instantaneous forward voltage	$I_F = 3.0\text{ A}$	$T_J = 25\text{ }^\circ\text{C}$	1.25		V
	$I_F = 4.0\text{ A}$		1.28		
	$I_F = 3.0\text{ A}$	$T_J = 150\text{ }^\circ\text{C}$	1.05		
Maximum instantaneous reverse current at rated DC blocking voltage		$T_J = 25\text{ }^\circ\text{C}$	10		$\mu\text{A}$
		$T_J = 150\text{ }^\circ\text{C}$	250		
Maximum reverse recovery time	$I_F = 0.5\text{ A}, I_R = 1.0\text{ A}, I_{rr} = 0.25\text{ A}$	$t_{rr}$	50		ns
Maximum reverse recovery time	$I_F = 1.0\text{ A}, di/dt = 50\text{ A}/\mu\text{s}, V_R = 30\text{ V}, I_{rr} = 10\% I_{RM}$	$t_{rr}$	75		ns
Maximum forward recovery time	$I_F = 1.0\text{ A}, di/dt = 100\text{ A}/\mu\text{s},$ recovery to 1.0 V	$t_{fr}$	25		ns

**Note**(1) Pulse test:  $t_p = 300\text{ }\mu\text{s}$ , duty cycle  $\leq 2\%$ **THERMAL CHARACTERISTICS** ( $T_A = 25\text{ }^\circ\text{C}$  unless otherwise noted)

PARAMETER	SYMBOL	MURS340	MURS360	UNIT
Typical thermal resistance junction to lead	$R_{\theta JL}$	11		$^\circ\text{C}/\text{W}$

**ORDERING INFORMATION** (Example)

PREFERRED P/N	UNIT WEIGHT (g)	PREFERRED PACKAGE CODE	BASE QUANTITY	DELIVERY MODE
MURS360-E3/57T	0.211	57T	850	7" diameter plastic tape and reel
MURS360-E3/9AT	0.211	9AT	3500	13" diameter plastic tape and reel
MURS360HE3_A/H (1)	0.211	H	850	7" diameter plastic tape and reel
MURS360HE3_A/I (1)	0.211	I	3500	13" diameter plastic tape and reel
MURS360-M3/57T	0.211	57T	850	7" diameter plastic tape and reel
MURS360-M3/9AT	0.211	9AT	3500	13" diameter plastic tape and reel
MURS360HM3_A/H (1)	0.211	H	850	7" diameter plastic tape and reel
MURS360HM3_A/I (1)	0.211	I	3500	13" diameter plastic tape and reel

**Note**

(1) AEC-Q101 qualified



### RATINGS AND CHARACTERISTICS CURVES ( $T_A = 25\text{ }^\circ\text{C}$ unless otherwise noted)

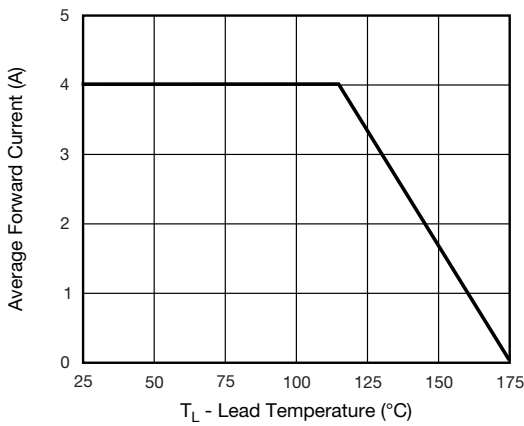

Fig. 1 - Forward Current Derating Curve

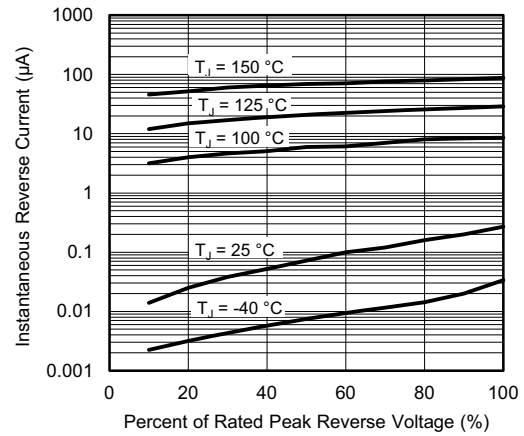

Fig. 4 - Typical Reverse Characteristics

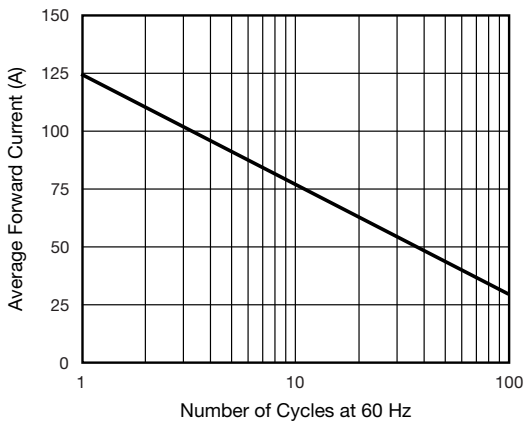

Fig. 2 - Maximum Non-Repetitive Peak Forward Surge Current

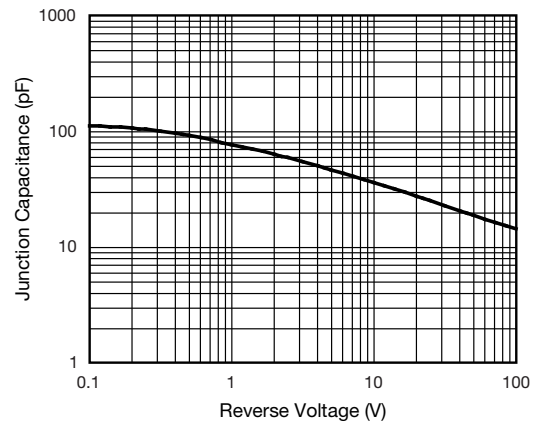

Fig. 5 - Typical Junction Capacitance

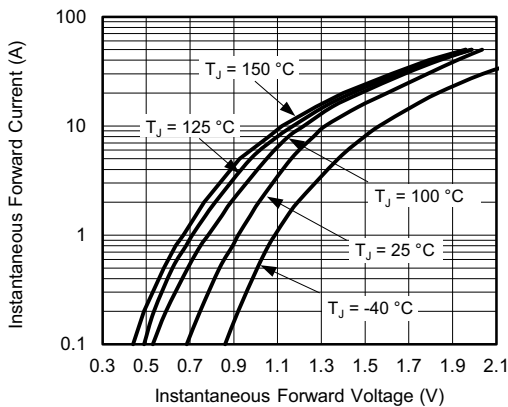

Fig. 3 - Typical Instantaneous Forward Characteristics

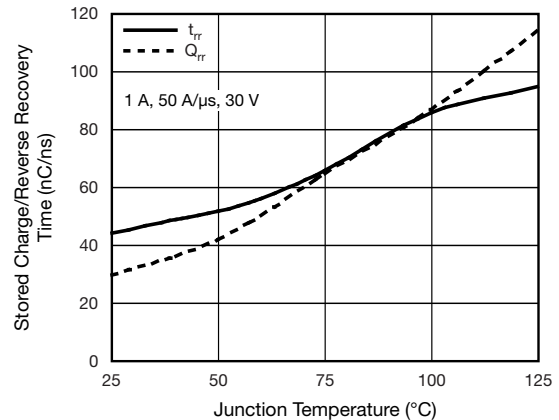
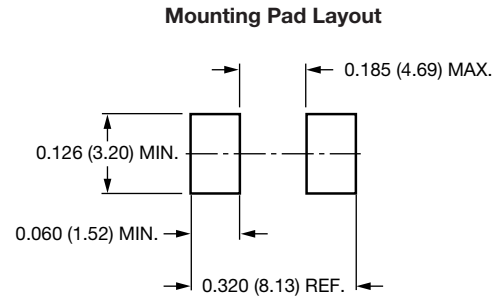
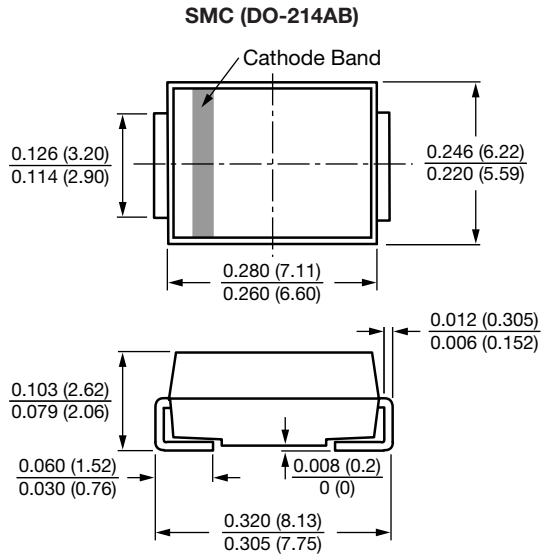

Fig. 6 - Typical Reverse Switching Characteristics



## PACKAGE OUTLINE DIMENSIONS in inches (millimeters)





## Disclaimer

ALL PRODUCT, PRODUCT SPECIFICATIONS AND DATA ARE SUBJECT TO CHANGE WITHOUT NOTICE TO IMPROVE RELIABILITY, FUNCTION OR DESIGN OR OTHERWISE.

Vishay Intertechnology, Inc., its affiliates, agents, and employees, and all persons acting on its or their behalf (collectively, "Vishay"), disclaim any and all liability for any errors, inaccuracies or incompleteness contained in any datasheet or in any other disclosure relating to any product.

Vishay makes no warranty, representation or guarantee regarding the suitability of the products for any particular purpose or the continuing production of any product. To the maximum extent permitted by applicable law, Vishay disclaims (i) any and all liability arising out of the application or use of any product, (ii) any and all liability, including without limitation special, consequential or incidental damages, and (iii) any and all implied warranties, including warranties of fitness for particular purpose, non-infringement and merchantability.

Statements regarding the suitability of products for certain types of applications are based on Vishay's knowledge of typical requirements that are often placed on Vishay products in generic applications. Such statements are not binding statements about the suitability of products for a particular application. It is the customer's responsibility to validate that a particular product with the properties described in the product specification is suitable for use in a particular application. Parameters provided in datasheets and / or specifications may vary in different applications and performance may vary over time. All operating parameters, including typical parameters, must be validated for each customer application by the customer's technical experts. Product specifications do not expand or otherwise modify Vishay's terms and conditions of purchase, including but not limited to the warranty expressed therein.

Except as expressly indicated in writing, Vishay products are not designed for use in medical, life-saving, or life-sustaining applications or for any other application in which the failure of the Vishay product could result in personal injury or death. Customers using or selling Vishay products not expressly indicated for use in such applications do so at their own risk. Please contact authorized Vishay personnel to obtain written terms and conditions regarding products designed for such applications.

No license, express or implied, by estoppel or otherwise, to any intellectual property rights is granted by this document or by any conduct of Vishay. Product names and markings noted herein may be trademarks of their respective owners.