

## Description

### Right-Angle 2-Row BergStik® II Headers Retentive Leg

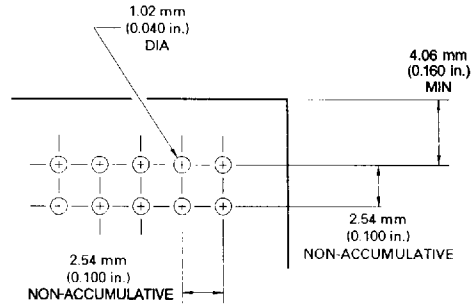

RECOMMENDED HOLE PATTERN

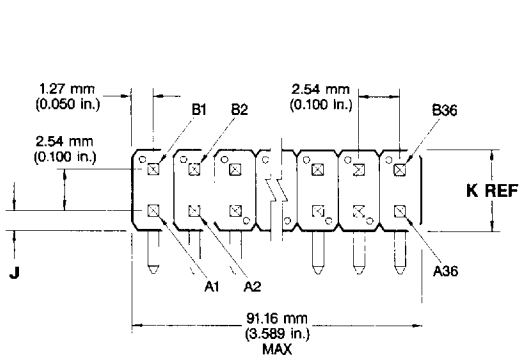
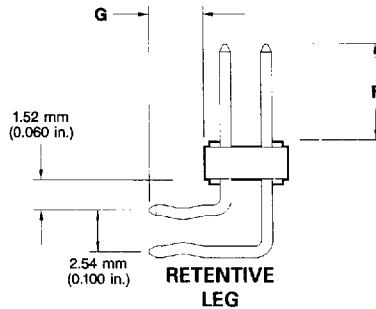
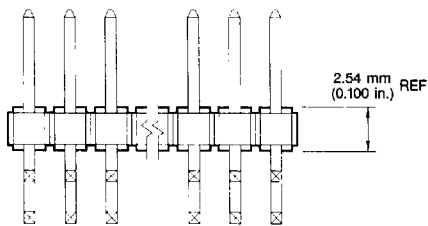

A183396-02018

Base number specifies pin length and style

These digits specify total number of positions (2 through 72 available)

## Ordering Data

□ □ □ □ - X Y Y H

This digit specifies plating

High temperature plastic

0.76  $\mu$ m (30  $\mu$ in.) gold over 1.27  $\mu$ m (50  $\mu$ in.) nickel  
0.38  $\mu$ m (15  $\mu$ in.) gold over 1.27  $\mu$ m (50  $\mu$ in.) nickel  
1.27  $\mu$ m (50  $\mu$ in.) gold over 1.27  $\mu$ m (50  $\mu$ in.) nickel

-1YY  
-2YY  
-3YY

3.81  $\mu$ m (150  $\mu$ in.) tin-lead  
0.38  $\mu$ m (15  $\mu$ in.) GXT™ over 1.27  $\mu$ m (50  $\mu$ in.) nickel  
0.76  $\mu$ m (30  $\mu$ in.) GXT™ over 1.27  $\mu$ m (50  $\mu$ in.) nickel

-4YY  
-5YY  
-6YY

## Plating

Part Numbers	Dimensions							
	F-Mating (Length Above Plastic)		G-Tail (Length Below Plastic)		J (Pin To Side)		K (Body Width)	
	mm	in.	mm	in.	mm	in.	mm	in.
69193-YYYH	5.84	0.230	3.05	0.120	1.14	0.045	4.83	0.190
78299-YYYH	5.84	0.230	3.05	0.120	1.78	0.070	6.10	0.240
86381-YYYH	6.35	0.250	3.05	0.120	1.78	0.070	6.10	0.240
93150-YYYH	6.99	0.275	3.05	0.120	1.14	0.045	4.83	0.190
78276-YYYH	8.08	0.318	3.05	0.120	1.78	0.070	6.10	0.240
87227-YYYH	8.08	0.318	3.05	0.120	1.14	0.045	4.83	0.190
93240-YYYH	8.59	0.338	3.05	0.120	1.78	0.070	6.10	0.240
94048-YYYH	9.65	0.380	3.05	0.120	1.78	0.070	6.10	0.240

Ordering data shown is for our standard product offering. For non-standard or custom products, contact your authorized Berg Electronics representative.

9005411 0002569 216

# Unshrouded Headers

2.54 x 2.54 mm (0.100 x 0.100 in.)  
Centerlines

**BergStik® II Headers**  
**BergCon® System**

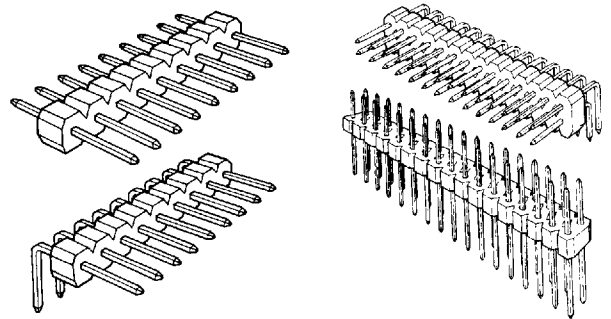

A183396-0775

## Features

- 1-Row: 1 through 36 total positions.  
2-Row: 2 through 72 total positions.  
3-Row: 9 through 108 total positions.
- End-to-end and side-to-side stackable on 2.54 mm (0.100 in.) centerlines.
- Can be manually broken to the desired length.
- Drawn (not stamped) 0.64 mm (0.025 in.) square wire presents four surfaces of equal quality.
- Standoffs allow cleaning to eliminate soldering contaminants.
- Optional retention tail provides 2.224 N (0.5 lbf) minimum retention prior to soldering on 1.58 mm (0.062 in.) thick pc boards.
- High-temperature plastic for infra-red soldering operations.
- Available with gold, GXT™ (palladium nickel alloy with gold flash) and tin-lead platings.

## Options

- Advanced ground.
- Retentive leg solder tails.
- Custom polarization available.

## Mating Data

Mates with 0.64 mm (0.025 in.) compatible receptacles on 2.54 mm (0.100 in.) centerlines.

Berg Electronics Products	Page
▪ Card Connectors . . . . .	13-122, 13-132, and 13-136
▪ PV™/Mini-latch Housing . . . . .	13-4 and 13-16
▪ Quickie III™ . . . . .	23-4
▪ Clincher™ . . . . .	20-2
▪ Mini-jump™ . . . . .	13-44

## Specifications

- MIL-G-45204
- MIL-P-55110
- MIL-P-81728
- QQ-W-343
- ASTM B-159

## Approvals and Certifications

 File no. E66906

 File no. LR46923

## Application Equipment

Description	Page
▪ Cutting tool HT-320 . . . . .	13-69

## Technical Data

### Materials

- Housing material . . . . . High temperature, Glass-filled PCT (UL 94 V-0)
  - ▶ Color . . . . . Black
  - ▶ Applicable soldering processes . . . . . Wave, Vapor-phase, IR reflow
- Pin . . . . . Phosphor-bronze

### Plating

- Underplate . . . . . 1.27 µm (50 µin.) nickel
- Finish . . . . . 0.38 µm (15 µin.) gold or 0.76 µm (30 µin.) gold or 1.27 µm (50 µin.) gold or 0.38 µm (15 µin.) GXT™ or 0.76 µm (30 µin.) GXT™
- Finish . . . . . 3.81 µm (150 µin.) tin-lead

### Electrical Performance

- Insulation resistance . . . . . 5000 MΩ min
- Withstanding voltage . . . . . 1500 V ac rms (sea level)

- Current rating . . . . . 3 amp continuous

### Mechanical Performance

- Retentive leg insertion force\* . . . . . >44.48 N (10 lbf) max\*
- Retentive leg connector retention . . . . . 2.22 N (0.5 lbf) min\*
- Contact retention (pin to housing) . . . . . 8.88 N (2 lbf)

### Operating Environment

- Temperature range . . . . . -65°C to +130°C

### Packaging

- Antistatic Bags
- Antistatic Tubes . . . . . available on selected part numbers

\*Per retentive pin-pair.

## Customer Support Materials

Description	Order No.	Description	Order No.
Customer Product Drawings . . . . .	By Part Number	Product Samples . . . . .	Upon Request
Product Specifications . . . . .	BUS-12-050	Test Data . . . . .	Upon Request
Product Substitutions . . . . .	Contact Technical Support		

■ 9005411 0002556 668 ■