



Frequency Generator & Integrated Buffers for Celeron & PII/III™

Recommended Application:

810/810E and 815 type chipset.

Output Features:

- 3 CPU (2.5V) (up to 133MHz achievable through I²C)
- 9 SDRAM (3.3V) (up to 133MHz achievable through I²C)
- 7 PCI (3.3 V) @ 33.3MHz
- 2 IOAPIC (2.5V) @ 33.3 MHz
- 3 Hublink clocks (3.3 V) @ 66.6 MHz
- 2 (3.3V) @ 48 MHz (Non spread spectrum)
- 1 REF (3.3V) @ 14.318 MHz

Features:

- Supports spread spectrum modulation, 0 to -0.5% down spread.
- I²C support for power management
- Efficient power management scheme through PD#
- Uses external 14.138 MHz crystal
- Alternate frequency selections available through I²C control.

Pin Configuration

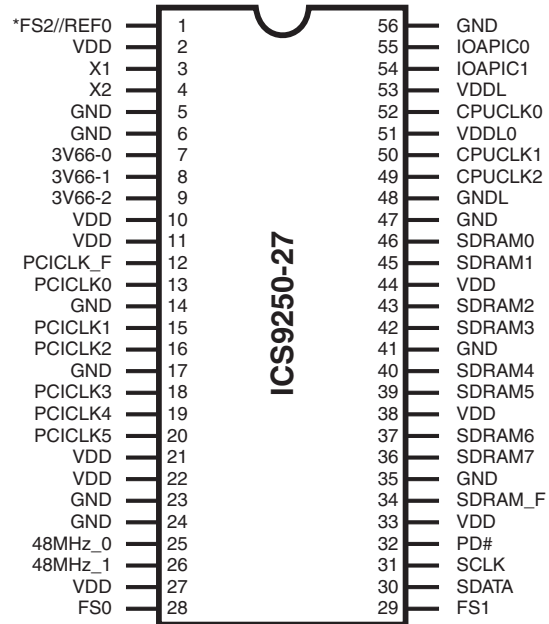

56-Pin 300mil SSOP

* This input has a 50KΩ pull-down to GND.

Block Diagram

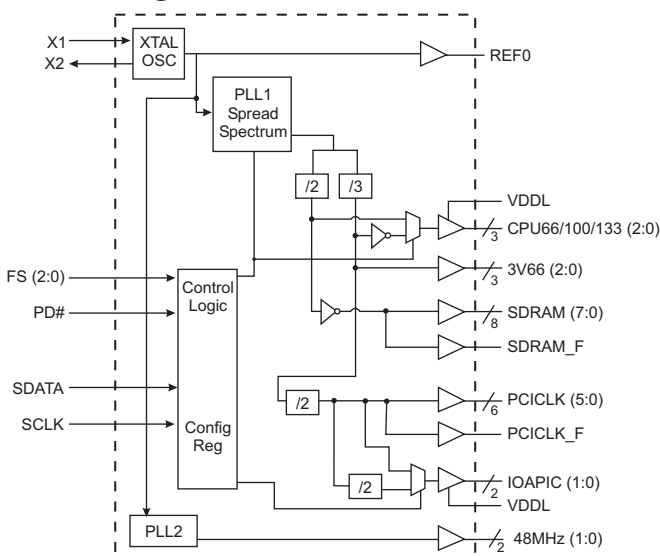

Functionality

FS2	FS1	FS0	Function
X	0	0	Tristate
X	0	1	Test
0	1	0	Active CPU = 66MHz SDRAM = 100MHz
0	1	1	Active CPU = 100MHz SDRAM = 100MHz
1	1	0	Active CPU = 133MHz SDRAM = 133MHz
1	1	1	Active CPU = 133MHz SDRAM = 100MHz

Power Groups

AVDD = Pin 22 Analog power for PLL
 AGND = Pin 23 Analog ground
 VDD48 = Pin 27 Analog power for 48MHz PLL
 GND = Pin 24 Analog ground for 48MHz PLL

ICS9250-27



General Description

The **ICS9250-27** is a single chip clock solution for 810/810E and 815 type chipset. It provides all necessary clock signals for such a system.

Spread spectrum may be enabled through I²C programming. Spread spectrum typically reduces EMI by 8dB to 10 dB. This simplifies EMI qualification without resorting to board design iterations or costly shielding. The ICS9250-27 employs a proprietary closed loop design, which tightly controls the percentage of spreading over process and temperature variations.

Pin Configuration

PIN NUMBER	PIN NAME	TYPE	DESCRIPTION
1	FS2	IN	Function Select pin. Determines CPU frequency, all output functionality
	REF0	OUT	3.3V, 14.318MHz reference clock output.
3	X1	IN	Crystal input, has internal load cap (33pF) and feedback resistor from X2
4	X2	OUT	Crystal output, nominally 14.318MHz. Has internal load cap (33pF)
5, 6, 14, 17, 23, 24, 35, 41, 47, 48, 56	GND	PWR	Ground pins for 3.3V supply
9, 8, 7	3V66 (2:0)	OUT	3.3V Fixed 66MHz clock outputs for HUB
2, 10, 11, 21, 22, 27, 33, 38, 44	VDD	PWR	3.3V power supply
12	PCICLK_F	OUT	Free running 3.3V PCI clock output
20, 19, 18, 16, 15, 13	PCICLK (5:0)	OUT	3.3V PCI clock outputs
25	48MHz_0	OUT	3.3V Fixed 48MHz clock outputs for USB
26	48MHz_1	OUT	3.3V fixed 48MHz clock output. Stronger output for graphics/video interface (minimum 1V/ns edge rate)
29, 28	FS (1:0)	IN	Function Select pins. Determines CPU frequency, all output functionality. Please refer to Functionality table on page 3.
30	SDATA	I/O	Data pin for I ² C circuitry 5V tolerant
31	SCLK	IN	Clock pin of I ² C circuitry 5V tolerant
32	PD#	IN	Asynchronous active low input pin used to power down the device into a low power state. The internal clocks are disabled and the VCO and the crystal are stopped. The latency of the power down will not be greater than 3ms.
36, 37, 39, 40, 42, 43, 45, 46	SDRAM (7:0)	OUT	3.3V output running 100MHz. All SDRAM outputs can be turned off through I ² C
34	SDRAM_F	OUT	3.3V free running 100MHz SDRAM, cannot be turned off through I ² C
49, 50, 52	CPUCLK (2:0)	OUT	2.5V Host bus clock output. 66MHz, 100MHz or 133MHz depending on FS pins.
51, 53	VDDL	PWR	2.5V power supply for CPU & IOAPIC
54, 55	IOAPIC (1:0)	OUT	2.5V clock outputs running at 33.3MHz.



Power Down Waveform

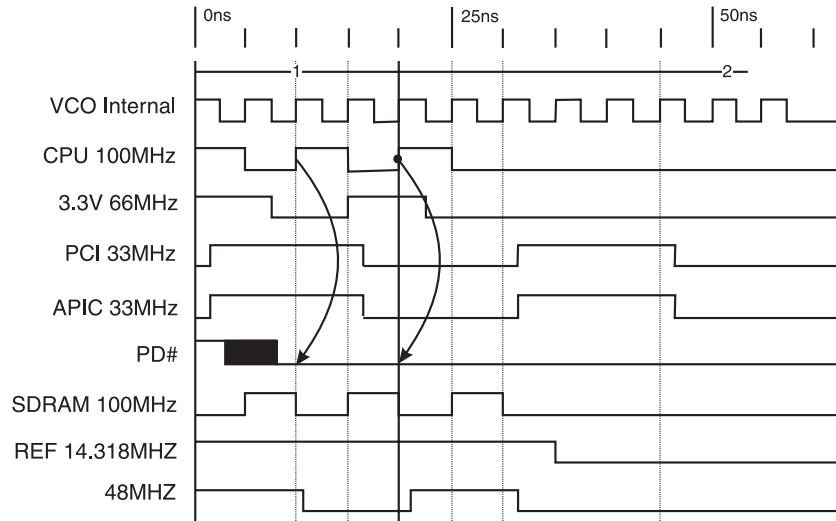

Note

1. After PD# is sampled active (Low) for 2 consecutive rising edges of CPUCLKs, all the output clocks are driven Low on their next High to Low transition.
2. Power-up latency <3ms.
3. Waveform shown for 100MHz

Maximum Allowed Current

815 Condition	Max 2.5V supply consumption Max discrete cap loads, Vddq2 = 2.625V All static inputs = Vddq3 or GND	Max 2.5V supply consumption Max discrete cap loads, Vddq2 = 3.465V All static inputs = Vddq3 or GND
Powerdown Mode (PWRDWN# = 0)	10mA	10mA
Full Active 66MHz FS[2:0] = 010	70mA	280mA
Full Active 100MHz FS[2:0] = 011	100mA	280mA
Full Active 133MHz FS[2:0] = 111		

Clock Enable Configuration

PD#	CPUCLK	SDRAM	IOAPIC	66MHz	PCICLK	REF, 48MHz	Osc	VCOs
0	LOW	LOW	LOW	LOW	LOW	LOW	OFF	OFF
1	ON	ON	ON	ON	ON	ON	ON	ON



Truth Table

FS2	FS1	FS0	CPU	SDRAM	3V66	PCI	48MHz	REF	IOAPIC
X	0	0	Tristate	Tristate	Tristate	Tristate	Tristate	Tristate	Tristate
X	0	1	TCLK/2	TCLK/2	TCLK/3	TCLK/6	TCLK/2	TCLK	TCLK/6
0	1	0	66.6 MHz	100 MHz	66.6 MHz	33.3 MHz	48 MHz	14.318 MHz	33.3 MHz
0	1	1	100 MHz	100 MHz	66.6 MHz	33.3 MHz	48 MHz	14.318 MHz	33.3 MHz
1	1	0	133 MHz	133 MHz	66.6 MHz	33.3 MHz	48 MHz	14.318 MHz	33.3 MHz
1	1	1	133 MHz	100 MHz	66.6 MHz	33.3 MHz	48 MHz	14.318 MHz	33.3 MHz

Byte 0: Control Register (1 = enable, 0 = disable)

Bit	Pin#	Name	PWD	Description
Bit 7		Reserved ID	0	(Active/Inactive)
Bit 6		Reserved ID	0	(Active/Inactive)
Bit 5		Reserved ID	0	(Active/Inactive)
Bit 4		Reserved ID	0	(Active/Inactive)
Bit 3		SpreadSpectrum (1=On/0=Off)	1	(Active/Inactive)
Bit 2	26	48MHz 1	1	(Active/Inactive)
Bit 1	25	48MHz 0	1	(Active/Inactive)
Bit 0	49	CPUCLK2	1	(Active/Inactive)

Note: Reserved ID bits must be wirtten as "0".

Byte 1: Control Register (1 = enable, 0 = disable)

Bit	Pin#	Name	PWD	Description
Bit 7	36	SDRAM7	1	(Active/Inactive)
Bit 6	37	SDRAM6	1	(Active/Inactive)
Bit 5	39	SDRAM5	1	(Active/Inactive)
Bit 4	40	SDRAM4	1	(Active/Inactive)
Bit 3	42	SDRAM3	1	(Active/Inactive)
Bit 2	43	SDRAM2	1	(Active/Inactive)
Bit 1	45	SDRAM1	1	(Active/Inactive)
Bit 0	46	SDRAM0	1	(Active/Inactive)

Notes:

1. Inactive means outputs are held LOW and are disabled from switching. These outputs are designed to be configured at power-on and are not expected to be configured during the normal modes of operation.
2. PWD = Power on Default



Byte 2: Control Register
(1 = enable, 0 = disable)

Bit	Pin#	Name	PWD	Description
Bit 7	9	3V66-2 (AGP)	1	(Active/Inactive)
Bit 6	20	PCICLK5	1	(Active/Inactive)
Bit 5	19	PCICLK4	1	(Active/Inactive)
Bit 4	18	PCICLK3	1	(Active/Inactive)
Bit 3	16	PCICLK2	1	(Active/Inactive)
Bit 2	15	PCICLK1	1	(Active/Inactive)
Bit 1	13	PCICLK0	1	(Active/Inactive)
Bit 0	-	Undefined bit	X	(Active/Inactive)

Notes:

1. Inactive means outputs are held LOW and are disabled from switching. These outputs are designed to be configured at power-on and are not expected to be configured during the normal modes of operation.
2. PWD = Power on Default
3. Undefined bit can be written with either a "1" or "0".

Byte 3: ICS Reserved Functionality and frequency select register (Default as noted in PWD)

Bit	Description								PWD
Bit7	ICS Reserved bit (Note 2)								0
Bit6	ICS Reserved bit (Note 2)								0
Bit5	ICS Reserved bit (Note 2)								0
Bit4	ICS Reserved bit (Note 2)								0
Bit3	ICS Reserved bit (Note 2)								0
Bit2	Undefined bit (Note 3)								X
Bit1	Undefined bit (Note 3)								X
Bit 0	Bit 0	FS0	FS1	CPUCLK MHz	SDRAM MHz	3V66 MHz	PCICLK MHz	IOAPIC MHz	0 Note 1
	0	0	0	66.66	100.0	66.66	33.33	33.33	
	0	1	0	100.0	100.0	66.66	33.33	33.33	
	0	0	1	133.32	133.32	66.66	33.33	33.33	
	0	1	1	133.32	100.0	66.66	33.33	33.33	
	1	0	0	66.66	100.0	66.66	33.33	33.33	
	1	1	0	100.0	100.0	66.66	33.33	33.33	
	1	0	1	133.32	133.32	66.66	33.33	33.33	
1	1	1	133.32	133.32	66.66	33.33	33.33		

Note 1: For system operation, the BSEL lines of the CPU will program FS0, FS2 for the appropriate CPU speed, always with SDRAM = 100MHz. After BIOS verifies the SDRAM is PC133 speed, then bit 0 can be written from the default 0 to 1 to change the SDRAM output frequency from 100MHz to 133MHz. This will only change if the CPU is at the 133MHz FSB speed as shown in this table. The CPU, 3v66, PCI, and IOAPIC clocks will be glitch free during this transition, and only SDRAM will change.

Note 2: "ICS RESERVED BITS" must be written as "0".

Note3: Undefined bits can be written either as "1 or 0"



Byte 4: Reserved Register
(1 = enable, 0 = disable)

Bit	Pin#	Name	PWD	Description
Bit 7	-	Reserved	0	(Active/Inactive)
Bit 6	-	Reserved	0	(Active/Inactive)
Bit 5	-	Reserved	0	(Active/Inactive)
Bit 4	-	Reserved	0	(Active/Inactive)
Bit 3	-	Reserved	0	(Active/Inactive)
Bit 2	-	Reserved	0	(Active/Inactive)
Bit 1	-	Reserved	0	(Active/Inactive)
Bit 0	-	Reserved	0	(Active/Inactive)

Byte 5: Reserved Register
(1 = enable, 0 = disable)

Bit	Pin#	Name	PWD	Description
Bit 7	-	Reserved	0	(Active/Inactive)
Bit 6	-	Reserved	0	(Active/Inactive)
Bit 5	-	Reserved	0	(Active/Inactive)
Bit 4	-	Reserved	0	(Active/Inactive)
Bit 3	-	Reserved	0	(Active/Inactive)
Bit 2	-	Reserved	0	(Active/Inactive)
Bit 1	-	Reserved	0	(Active/Inactive)
Bit 0	-	Reserved	0	(Active/Inactive)

Notes:

1. Inactive means outputs are held LOW and are disabled from switching. These outputs are designed to be configured at power-on and are not expected to be configured during the normal modes of operation.
2. PWD = Power on Default

Group Timing Relationship Table¹

Group	CPU 66MHz SDRAM 100MHz		CPU 100MHz SDRAM 100MHz		CPU 133MHz SDRAM 100MHz		CPU 133MHz SDRAM 133MHz	
	Offset	Tolerance	Offset	Tolerance	Offset	Tolerance	Offset	Tolerance
CPU to SDRAM	2.5ns	500ps	5.0ns	500ps	0.0ns	500ps	3.75ns	500ps
CPU to 3V66	7.5ns	500ps	5.0ns	500ps	0.0ns	500ps	0.0ns	500ps
SDRAM to 3V66	0.0ns	500ps	0.0ns	500ps	0.0ns	500ps	3.75ns	500ps
3V66 to PCI	1.5-3.5ns	N/A	1.5-3.5ns	N/A	1.5-3.5ns	N/A	1.5 -3.5ns	N/A
IOAPIC to PCI	0.0ns	1.0ns	0.0ns	1.0ns	0.0ns	1.0ns	0.0ns	1.0ns
USB & DOT	Asynch	N/A	Asynch	N/A	Asynch	N/A	Asynch	N/A



Absolute Maximum Ratings

- Core Supply Voltage 4.6 V
- I/O Supply Voltage 3.6V
- Logic Inputs GND -0.5 V to V_{DD} +0.5 V
- Ambient Operating Temperature 0°C to +70°C
- Storage Temperature -65°C to +150°C

Stresses above those listed under *Absolute Maximum Ratings* may cause permanent damage to the device. These ratings are stress specifications only and functional operation of the device at these or any other conditions above those listed in the operational sections of the specifications is not implied. Exposure to absolute maximum rating conditions for extended periods may affect product reliability.

Electrical Characteristics - Input/Supply/Common Output Parameters

T_A = 0 - 70C; Supply Voltage V_{DD} = 3.3 V +/-5%, V_{DDL} = 2.5 V +/-5% (unless otherwise stated)

PARAMETER	SYMBOL	CONDITIONS	MIN	TYP	MAX	UNITS	
Input High Voltage	V _{IH}		2		V _{DD} +0.3	V	
Input Low Voltage	V _{IL}		V _{SS} -0.3		0.8	V	
Input High Current	I _{IH}	V _{IN} = V _{DD}	-5		5	μA	
Input Low Current	I _{IL1}	V _{IN} = 0 V; Inputs with no pull-up resistors	-5	2		μA	
	I _{IL2}	V _{IN} = 0 V; Inputs with pull-up resistors	-200	-100			
Operating Supply Current	I _{DD3.3OP}	C _L = 0 pF; Select @ 66 MHz		97	115	mA	
		C _L = 0 pF; Select @ 100 MHz		91	110		
		C _L = 0 pF; Select @ 133 MHz		100	165		
		C _L = Max loads; Select @ 66 MHz		295	330	mA	
		C _L = Max loads; Select @ 100 MHz		280	320		
		C _L = Max loads; Select @ 133 MHz		300	395		
	I _{DD2.5OP}	C _L = 0 pF; Select @ 66 MHz			16	19	mA
		C _L = 0 pF; Select @ 100 MHz			25	35	
		C _L = 0 pF; Select @ 133 MHz			26	40	
		C _L = Max loads; Select @ 66 MHz			19	30	mA
C _L = Max loads; Select @ 100 MHz				34	50		
C _L = Max loads; Select @ 133 MHz				40	70		
Powerdown Current	I _{DD3.3PD}	C _L = Max loads		220	400	μA	
	I _{DD.25PD}	Input address VDD or GND		<1	10		
Input Frequency	F _i	V _{DD} = 3.3 V	12	14.318	16	MHz	
Pin Inductance	L _{pin}			7		nH	
Input Capacitance ¹	C _{IN}	Logic Inputs			5	pF	
	C _{OUT}	Output pin capacitance		6		pF	
	C _{INX}	X1 & X2 pins	27		45	pF	
Transition time ¹	T _{trans}	To 1st crossing of target frequency			5	ms	
Settling time ¹	T _s	From 1st crossing to 1% target frequency			5	ms	
Clk Stabilization ¹	T _{STAB}	From V _{DD} = 3.3 V to 1% target frequency			5	ms	
Delay ¹	t _{PZH} , t _{PZL}	Output enable delay (all outputs)	1		10	ns	
	t _{PHZ} , t _{PLZ}	Output disable delay (all outputs)	1		10	ns	

¹Guaranteed by design, not 100% tested in production.



Electrical Characteristics - CPU

$T_A = 0 - 70^\circ\text{C}$; $V_{DDL} = 2.5 \text{ V} \pm 5\%$; $C_L = 10\text{-}20 \text{ pF}$ (unless otherwise specified)

PARAMETER	SYMBOL	CONDITIONS	MIN	TYP	MAX	UNITS
Output Impedance	R_{DSP2B}^1	$V_O = V_{DD}^*(0.5)$	13.5	22	45	Ω
Output Impedance	R_{DSN2B}^1	$V_O = V_{DD}^*(0.5)$	13.5	23	45	Ω
Output High Voltage	V_{OH2B}	$I_{OH} = -1 \text{ mA}$	2			V
Output Low Voltage	V_{OL2B}	$I_{OL} = 1 \text{ mA}$			0.4	V
Output High Current	I_{OH2B}	$V_{OH @ MIN} = 1.0 \text{ V}$	-27	-68		mA
		$V_{OH @ MAX} = 2.375 \text{ V}$		-9	-27	
Output Low Current	I_{OL2B}	$V_{OL @ MIN} = 1.2 \text{ V}$	27	54		mA
		$V_{OL @ MAX} = 0.3 \text{ V}$		11	30	
Rise Time ¹	t_{r2B}	$V_{OL} = 0.4 \text{ V}$, $V_{OH} = 2.0 \text{ V}$	0.4	1.1	1.6	ns
Fall Time ¹	t_{f2B}	$V_{OH} = 2.0 \text{ V}$, $V_{OL} = 0.4 \text{ V}$	0.4	1.1	1.6	ns
Duty Cycle ¹	d_{t2B}	$V_T = 1.25 \text{ V}$, 66, 100 MHz	45	50	55	%
		$V_T = 1.25 \text{ V}$, 133 MHz	45	53	55	
Skew window ¹	t_{sk2B}	$V_T = 1.25 \text{ V}$		118	175	ps
Jitter, Cycle-to-cycle ¹	$t_{jyc-cyc2B}$	$V_T = 1.25 \text{ V}$		148	250	ps

¹Guaranteed by design, not 100% tested in production.

Electrical Characteristics - 3V66

$T_A = 0 - 70^\circ\text{C}$; $V_{DD} = 3.3 \text{ V} \pm 5\%$; $C_L = 10\text{-}20 \text{ pF}$ (unless otherwise specified)

PARAMETER	SYMBOL	CONDITIONS	MIN	TYP	MAX	UNITS
Output Impedance	R_{DSP1}^1	$V_O = V_{DD}^*(0.5)$	12	17	55	Ω
Output Impedance	R_{DSN1}^1	$V_O = V_{DD}^*(0.5)$	12	18	55	Ω
Output High Voltage	V_{OH1}	$I_{OH} = -1 \text{ mA}$	2.4			V
Output Low Voltage	V_{OL1}	$I_{OL} = 1 \text{ mA}$			0.55	V
Output High Current	I_{OH1}	$V_{OH @ MIN} = 1.0 \text{ V}$	-33	-108		mA
		$V_{OH @ MAX} = 3.135 \text{ V}$		-9	-33	
Output Low Current	I_{OL1}	$V_{OL @ MIN} = 1.95 \text{ V}$	30	95		mA
		$V_{OL @ MAX} = 0.4 \text{ V}$		29	38	
Rise Time ¹	t_{r1}	$V_{OL} = 0.4 \text{ V}$, $V_{OH} = 2.4 \text{ V}$	0.4	1.2	1.8	ns
Fall Time ¹	t_{f1}	$V_{OH} = 2.4 \text{ V}$, $V_{OL} = 0.4 \text{ V}$	0.4	1.3	1.8	ns
Duty Cycle ¹	d_{t1}	$V_T = 1.5 \text{ V}$	45	50	55	%
Skew window ¹	t_{sk1}	$V_T = 1.5 \text{ V}$		82	175	ps
Jitter, Cycle-to-cycle ¹	$t_{jyc-cyc1}$	$V_T = 1.5 \text{ V}$		123	500	ps

¹Guaranteed by design, not 100% tested in production.



Electrical Characteristics - IOAPIC

T_A = 0 - 70C; V_{DDL} = 2.5 V +/-5%; C_L = 10-20 pF (unless otherwise specified)

PARAMETER	SYMBOL	CONDITIONS	MIN	TYP	MAX	UNITS
Output Impedance	R _{DSP4B} ¹	V _O = V _{DD} *(0.5)	9	21.5	30	Ω
Output Impedance	R _{DSN4B} ¹	V _O = V _{DD} *(0.5)	9	23	30	Ω
Output High Voltage	V _{OH4B}	I _{OH} = -1 mA	2			V
Output Low Voltage	V _{OL4B}	I _{OL} = 1 mA			0.4	V
Output High Current	I _{OH4B}	V _{OH @ MIN} = 1.0 V	-27	-68		mA
		V _{OH @ MAX} = 2.375 V		-9	-27	
Output Low Current	I _{OL4B}	V _{OL @ MIN} = 1.2 V	27	54		mA
		V _{OL @ MAX} = 0.3 V		11	30	
Rise Time ¹	t _{r4B}	V _{OL} = 0.4 V, V _{OH} = 2.0 V	0.4	1.1	1.6	ns
Fall Time ¹	t _{f4B}	V _{OH} = 2.0 V, V _{OL} = 0.4 V	0.4	1.1	1.6	ns
Duty Cycle ¹	d _{t4B}	V _T = 1.25 V	45	50	55	%
Jitter, Cycle-to-cycle ¹	t _{jyc-cyc4B}	V _T = 1.25 V		123	500	ps

¹Guaranteed by design, not 100% tested in production.

Electrical Characteristics - SDRAM

T_A = 0 - 70C; V_{DD} = 3.3 V +/-5%; C_L = 20-30 pF (unless otherwise specified)

PARAMETER	SYMBOL	CONDITIONS	MIN	TYP	MAX	UNITS
Output Impedance	R _{DSP3} ¹	V _O = V _{DD} *(0.5)	10	14	24	Ω
Output Impedance	R _{DSN3} ¹	V _O = V _{DD} *(0.5)	10	18	24	Ω
Output High Voltage	V _{OH3}	I _{OH} = -1 mA	2.4			V
Output Low Voltage	V _{OL3}	I _{OL} = 1 mA			0.4	V
Output High Current	I _{OH3}	V _{OH @ MIN} = 2.0 V	-54	-92		mA
		V _{OH @ MAX} = 3.135 V		-16	-46	
Output Low Current	I _{OL3}	V _{OL @ MIN} = 1.0 V	54	68		mA
		V _{OL @ MAX} = 0.4 V		29	53	
Rise Time ¹	t _{r3}	V _{OL} = 0.4 V, V _{OH} = 2.4 V	0.4	1	1.6	ns
Fall Time ¹	t _{f3}	V _{OH} = 2.4 V, V _{OL} = 0.4 V	0.4	1.5	1.6	ns
Duty Cycle ¹	d _{t3}	V _T = 1.5 V	45	52	55	%
Skew window ¹	t _{sk3}	V _T = 1.5 V		164	250	ps
Jitter, Cycle-to-cycle ¹	t _{jyc-cyc3}	V _T = 1.5 V, 66, 100 MHz		180	250	ps

¹Guaranteed by design, not 100% tested in production.



Electrical Characteristics - PCI

T_A = 0 - 70°C; V_{DD} = 3.3 V +/-5%; C_L = 10-30 pF (unless otherwise specified)

PARAMETER	SYMBOL	CONDITIONS	MIN	TYP	MAX	UNITS
Output Impedance	R _{DSP1} ¹	V _O = V _{DD} *(0.5)	12	14	55	Ω
Output Impedance	R _{DNS1} ¹	V _O = V _{DD} *(0.5)	12	18	55	Ω
Output High Voltage	V _{OH1}	I _{OH} = -1 mA	2.4			V
Output Low Voltage	V _{OL1}	I _{OL} = 1 mA			0.55	V
Output High Current	I _{OH1}	V _{OH @ MIN} = 1.0 V	-33	-106		mA
		V _{OH @ MAX} = 3.135 V		-14	-33	
Output Low Current	I _{OL1}	V _{OL @ MIN} = 1.95 V	30	94		mA
		V _{OL @ MAX} = 0.4 V		29	38	
Rise Time ¹	t _{r1}	V _{OL} = 0.4 V, V _{OH} = 2.4 V	0.4	1.3	2	ns
Fall Time ¹	t _{f1}	V _{OH} = 2.4 V, V _{OL} = 0.4 V	0.4	1.4	2	ns
Duty Cycle ¹	d _{t1}	V _T = 1.5 V	45	52	55	%
Skew window ¹	t _{sk1}	V _T = 1.5 V		304	500	ps
Jitter, Cycle-to-cycle ¹	t _{jcc-cyc1}	V _T = 1.5 V		170	500	ps

¹Guaranteed by design, not 100% tested in production.

Electrical Characteristics - REF, 48MHz_0 (Pin 25)

T_A = 0 - 70°C; V_{DD} = 3.3 V +/-5%; C_L = 10-20 pF (unless otherwise specified)

PARAMETER	SYMBOL	CONDITIONS	MIN	TYP	MAX	UNITS
Output Impedance	R _{DSP5} ¹	V _O = V _{DD} *(0.5)	20	32.6	60	Ω
Output Impedance	R _{DNS5} ¹	V _O = V _{DD} *(0.5)	20	31	60	Ω
Output High Voltage	V _{OH15}	I _{OH} = -1 mA	2.4			V
Output Low Voltage	V _{OL5}	I _{OL} = 1 mA			0.55	V
Output High Current	I _{OH5}	V _{OH @ MIN} = 1.0 V	-29	-54		mA
		V _{OH @ MAX} = 3.135 V		-11	-23	
Output Low Current	I _{OL5}	V _{OL @ MIN} = 1.95 V	29	54		mA
		V _{OL @ MAX} = 0.4 V		16	27	
Rise Time ¹	t _{r5}	V _{OL} = 0.4 V, V _{OH} = 2.4 V	0.4	1.4	4	ns
Fall Time ¹	t _{f5}	V _{OH} = 2.4 V, V _{OL} = 0.4 V	0.4	1.7	4	ns
Duty Cycle ¹	d _{t5}	V _T = 1.5 V	45	53	55	%
Jitter, Cycle-to-cycle ¹	t _{jcc-cyc5}	V _T = 1.5 V, Fixed clocks		215	500	ps
Jitter, Cycle-to-cycle ¹	t _{jcc-cyc5}	V _T = 1.5 V, Ref clocks		930	1000	ps

¹Guaranteed by design, not 100% tested in production.



Electrical Characteristics - 48MHz_1 (Pin 26)

T_A = 0 - 70C; V_{DD} = 3.3 V +/-5%; C_L = 10-15 pF (unless otherwise specified)

PARAMETER	SYMBOL	CONDITIONS	MIN	TYP	MAX	UNITS
Output Impedance	R _{DSP3} ¹	V _O = V _{DD} *(0.5)	10	16.7	24	Ω
Output Impedance	R _{DSN3} ¹	V _O = V _{DD} *(0.5)	10	18.4	24	Ω
Output High Voltage	V _{OH3}	I _{OH} = -1 mA	2.4			V
Output Low Voltage	V _{OL3}	I _{OL} = 1 mA			0.55	V
Output High Current	I _{OH3}	V _{OH @ MIN} = 2.0 V	-54	-82		mA
		V _{OH @ MAX} = 3.135 V		-20	-46	
Output Low Current	I _{OL3}	V _{OL @ MIN} = 1.0 V	54	95		mA
		V _{OL @ MAX} = 0.4 V		28	53	
Rise Time ¹	t _{r3}	V _{OL} = 0.4 V, V _{OH} = 2.4 V	0.4	1.1	1.6	ns
Fall Time ¹	t _{f3}	V _{OH} = 2.4 V, V _{OL} = 0.4 V	0.4	1.1	1.6	ns
Duty Cycle ¹	d _{t3}	V _T = 1.5 V	45	51	55	%
Skew	t _{sk3}	V _T = 1.5 V		116	250	ps
Jitter, Cycle-to-cycle ¹	t _{jcc-cyc3B}	V _T = 1.5 V		196	500	ps

¹Guaranteed by design, not 100% tested in production.

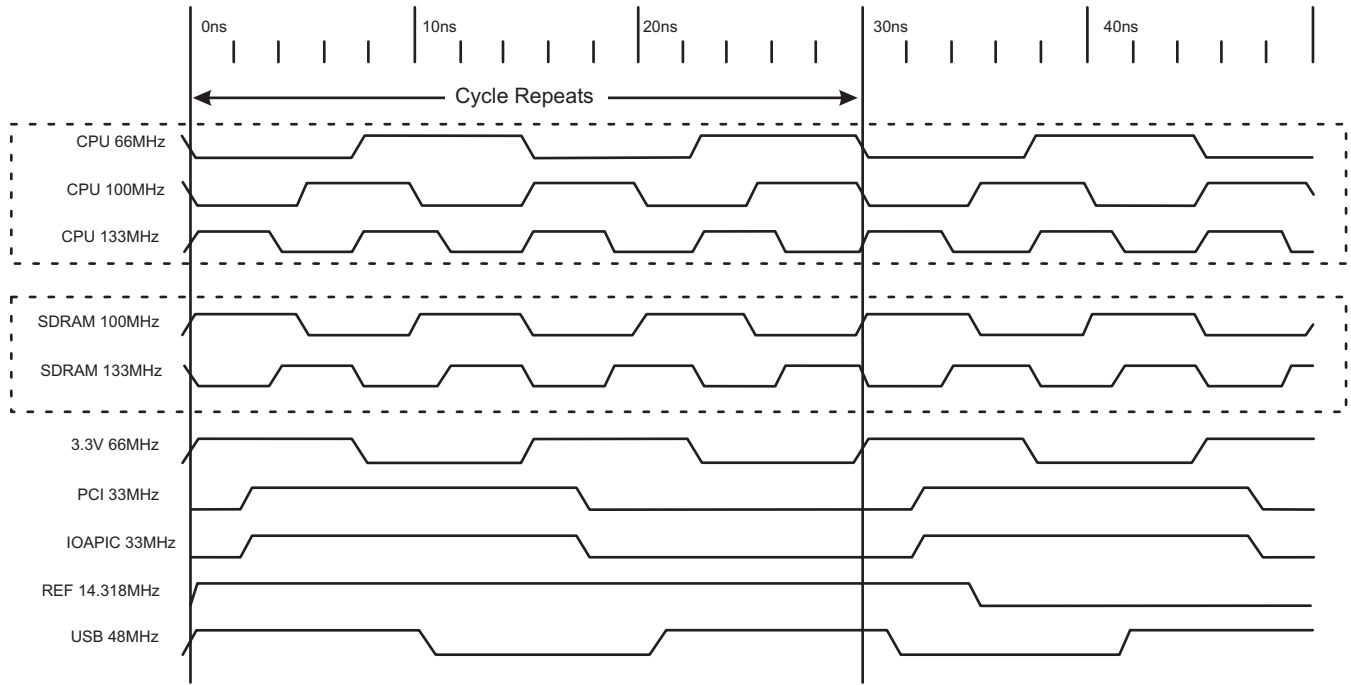

Group Offset Waveforms



General I²C serial interface information

The information in this section assumes familiarity with I²C programming.

How to Write:

- Controller (host) sends a start bit.
- Controller (host) sends the write address D2_(H)
- ICS clock will **acknowledge**
- Controller (host) sends a dummy command code
- ICS clock will **acknowledge**
- Controller (host) sends a dummy byte count
- ICS clock will **acknowledge**
- Controller (host) starts sending first byte (Byte 0) through byte 5
- ICS clock will **acknowledge** each byte *one at a time*.

How to Write:	
Controller (Host)	ICS (Slave/Receiver)
Start Bit	
Address D2 _(H)	
	ACK
Dummy Command Code	
	ACK
Dummy Byte Count	
	ACK
Byte 0	
	ACK
Byte 1	
	ACK
Byte 2	
	ACK
Byte 3	
	ACK
Byte 4	
	ACK
Byte 5	
	ACK
Stop Bit	

How to Read:

- Controller (host) will send start bit.
- Controller (host) sends the read address D3_(H)
- ICS clock will **acknowledge**
- ICS clock will send the **byte count**
- Controller (host) acknowledges
- ICS clock sends first byte (**Byte 0**) through **byte 5**
- Controller (host) will need to acknowledge each byte
- Controller (host) will send a stop bit

How to Read:	
Controller (Host)	ICS (Slave/Receiver)
Start Bit	
Address D3 _(H)	
	ACK
	Byte Count
ACK	
	Byte 0
ACK	
	Byte 1
ACK	
	Byte 2
ACK	
	Byte 3
ACK	
	Byte 4
ACK	
	Byte 5
ACK	
Stop Bit	

Notes:

1. The ICS clock generator is a slave/receiver, I²C component. It can read back the data stored in the latches for verification. **Read-Back will support Intel PIIX4 "Block-Read" protocol.**
2. The data transfer rate supported by this clock generator is 100K bits/sec or less (standard mode)
3. The input is operating at 3.3V logic levels.
4. The data byte format is 8 bit bytes.
5. To simplify the clock generator I²C interface, the protocol is set to use only "**Block-Writes**" from the controller. The bytes must be accessed in sequential order from lowest to highest byte with the ability to stop after any complete byte has been transferred. The Command code and Byte count shown above must be sent, but the data is ignored for those two bytes. The data is loaded until a Stop sequence is issued.
6. At power-on, all registers are set to a default condition, as shown.

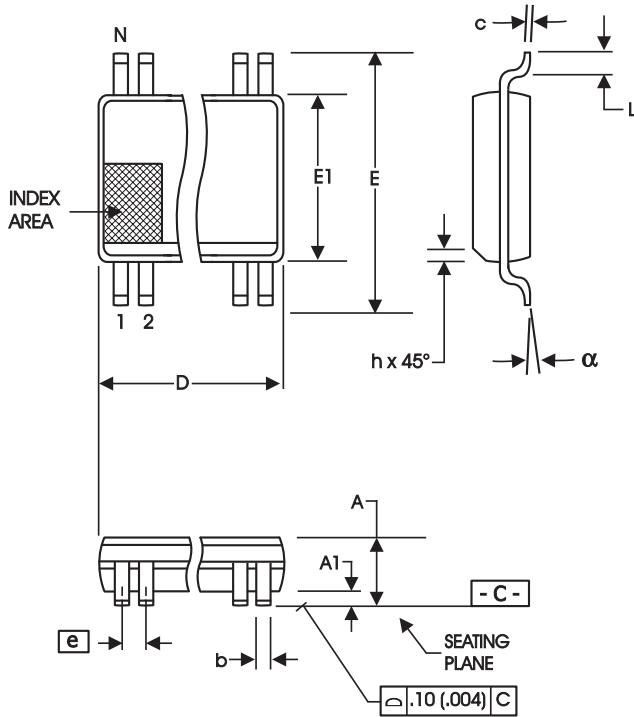

56-Lead, 300 mil Body, 25 mil, SSOP

SYMBOL	In Millimeters COMMON DIMENSIONS		In Inches COMMON DIMENSIONS	
	MIN	MAX	MIN	MAX
A	2.41	2.80	.095	.110
A1	0.20	0.40	.008	.016
b	0.20	0.34	.008	.0135
c	0.13	0.25	.005	.010
D	SEE VARIATIONS		SEE VARIATIONS	
E	10.03	10.68	.395	.420
E1	7.40	7.60	.291	.299
e	0.635 BASIC		0.025 BASIC	
h	0.38	0.64	.015	.025
L	0.50	1.02	.020	.040
N	SEE VARIATIONS		SEE VARIATIONS	
α	0°	8°	0°	8°

VARIATIONS

N	D mm.		D (inch)	
	MIN	MAX	MIN	MAX
56	18.31	18.55	.720	.730

Reference Doc.: JEDEC Publication 95, MO-118

10-0034

Ordering Information

ICS9250_yF-27LF-T

Example:

ICS XXXX y F - PPP LF - T

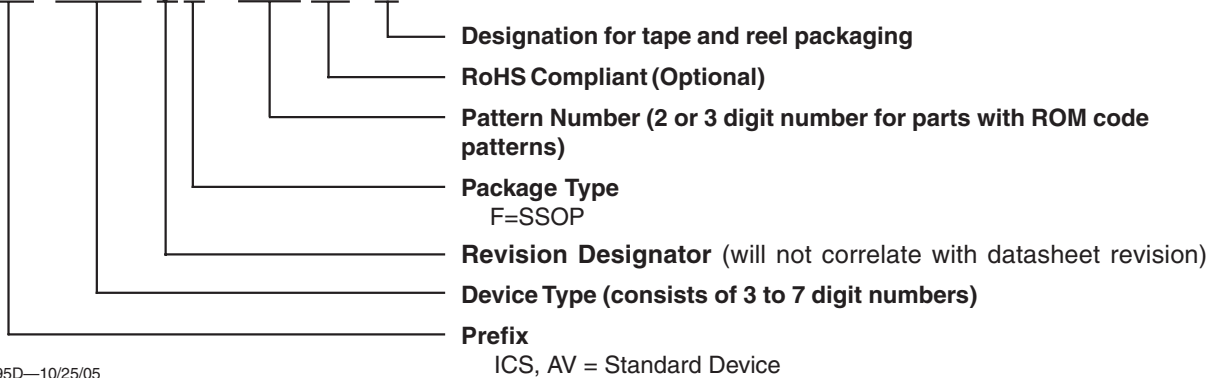



Revision History

Rev.	Issue Date	Description	Page #
C	8/17/2005	Added LF Ordering Information	14
D	10/25/2005	Removed "Contact ICS for an I ² C programming application" note reference.	13

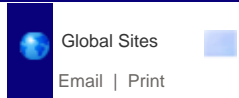

Contact IDT | Investors | Press

Document Search | Package Search | Parametric Search | Cross Reference Search | Green & RoHS | Calculators | Thermal Data | Reliability & Quality | Military

Home > Products > Timing Solutions > PC-Notebook-Server Clocks > Clock Synthesizer by Chipset Vendor > Desktop Chipsets > 9250-27

[Add to myIDT \[?\]](#)

You may also like...

9250-27 (Desktop Chipsets)

Description

810/810E and 815 type chipset.

Market Group

PC CLOCK

Additional Info

Output Features: • 3 CPU (2.5V) (up to 133MHz achievable through I2C) • 9 SDRAM (3.3V) (up to 133MHz achievable through I2C) • 7 PCI (3.3 V) @33.3MHz • 2 IOAPIC (2.5V) @ 33.3 MHz • 3 Hublink clocks (3.3 V) @ 66.6 MHz • 2 (3.3V) @ 48 MHz (Non spread spectrum) • 1 REF (3.3V) @ 14.318 MHz



Related Orderable Parts

Attributes	9250BF-27	9250BF-27LF	9250BF-27LFT	9250BF-27T
Voltage	3.3 V (PV56)	3.3 V (PVG56)	3.3 V (PVG56)	3.3 V (PV56)
Package	SSOP 56	SSOP 56	SSOP 56	SSOP 56
Speed	NA	NA	NA	NA
Temperature	C	C	C	C
Status	Active	Active	Active	Active
Sample	Yes	Yes	No	No
Minimum Order Quantity	104	104	1000	1000
Factory Order Increment	26	26	1000	1000

Related Documents

Type	Title	Size	Revision Date
Datasheet	9250-27 Datasheet	191 KB	03/24/2006
Model - IBIS	9250-27 IBIS Model	243 KB	03/24/2006

Node: www.idt.com