

### Pin Header 4.2mm 2 Row H=2.5mm SMT Type

#### Specifications

Current Rate: 7 AMP  
 Insulation Resistance: 1000MΩ Min.  
 Contact Resistance: 20mΩ Max.  
 Dielectric Voltage: 1000V AC for one minute  
 Operation Temperature: -40°C to +105°C

#### Material

Insulator: Polyester, UL 94V-0  
 ©Standard SMT: Nylon 6T,  
 Straight: Nylon 66  
 Terminal: Copper Alloy  
 Plating: Tin Plated

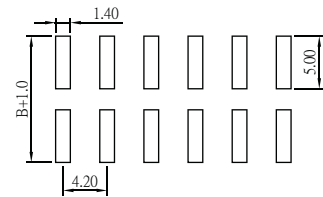
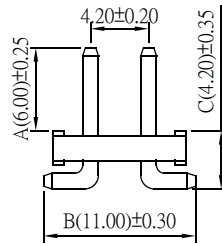
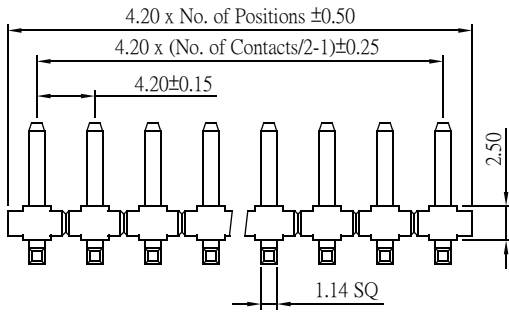
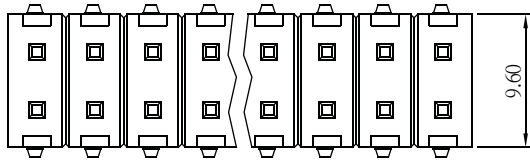
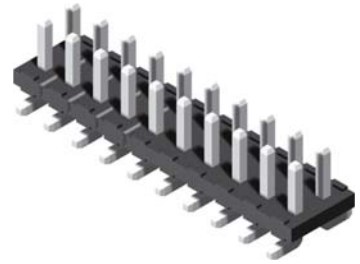

Recommended PCB Layout  
 (PCB TOLERANCE ±0.05)

Part No.: PH42M25-2XX-U

### Pin Header 4.2mm 2 Row H=2.5mm Straight Type

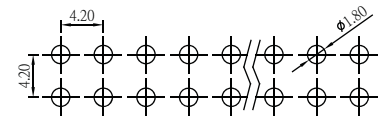
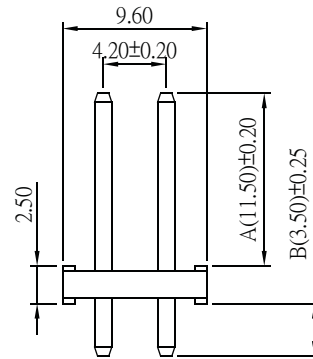
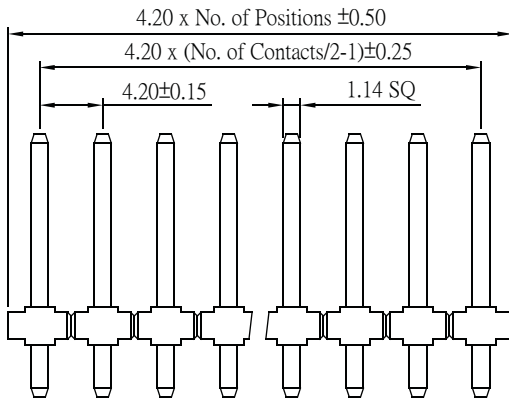
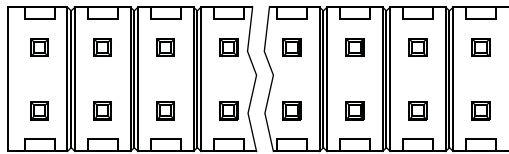

Recommended PCB Layout  
 (PCB TOLERANCE ±0.05)

Part No.: PH42S25-2XX-L

## ORDER INFORMATION

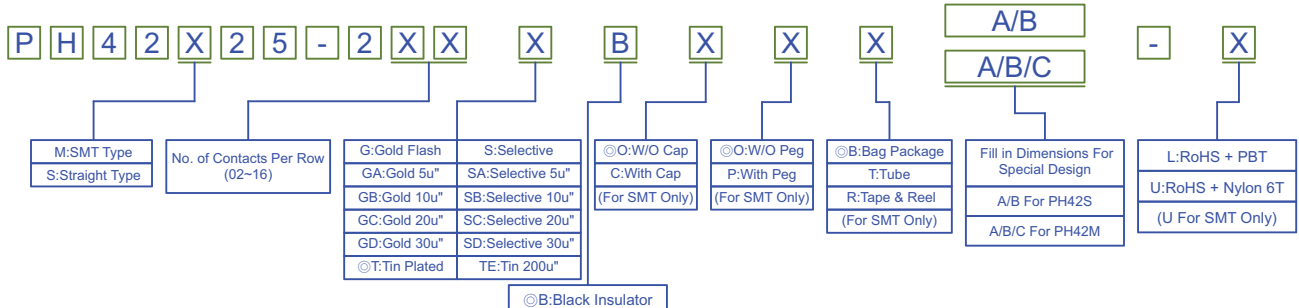

©Standard Recommended