



M2107

LINEAR INTEGRATED CIRCUIT

SINGLE OPERATIONAL AMPLIFIER

DESCRIPTION

The UTC M2107 is the single operational amplifier of ultra miniature surface mount package. It has features of low operating supply voltage and low saturation output voltage. It is suitable for small electronic equipments and hybrid circuits.

FEATURES

- *Operating Voltage (V⁺/V⁻ = ±1.0V to ±3.5V)
- *Low Output Saturation: (4Vp-p at single 5V supply)
- *V⁻ Shield Plate Between +Input and -Input
- *Suitable Pin Arrangement for Application
- *Bipolar Technology

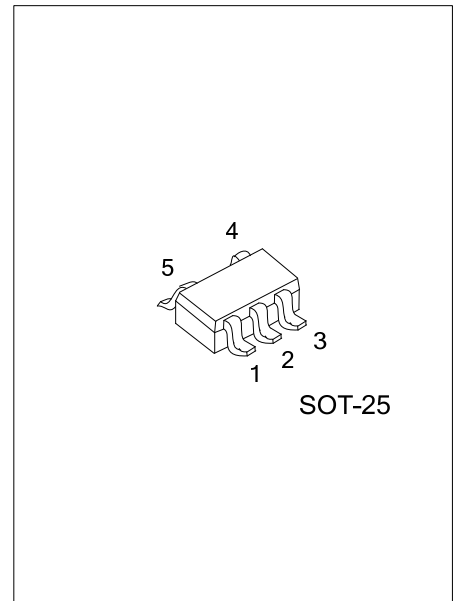

ORDERING INFORMATION

Ordering Number		Package	Pin Assignment					Packing
Lead Free	Halogen Free		1	2	3	4	5	
M2107L-AF5-R	M2107G-AF5-R	SOT-25	I ⁺	V ⁻	I ⁻	O	V ⁺	Tape Reel

Note: Pin Assignment: I: V_{IN} O: Output

<p>M2107L-AF5-R</p> <p>(1) Packing Type (2) Package Type (3) Lead Free</p>	<p>(1) R: Tape Reel (2) AF5: SOT-25 (3) G: Halogen Free, L: Lead Free</p>
--	---

MARKING

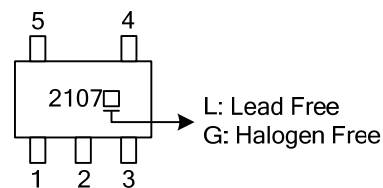

■ BLOCK DIAGRAM

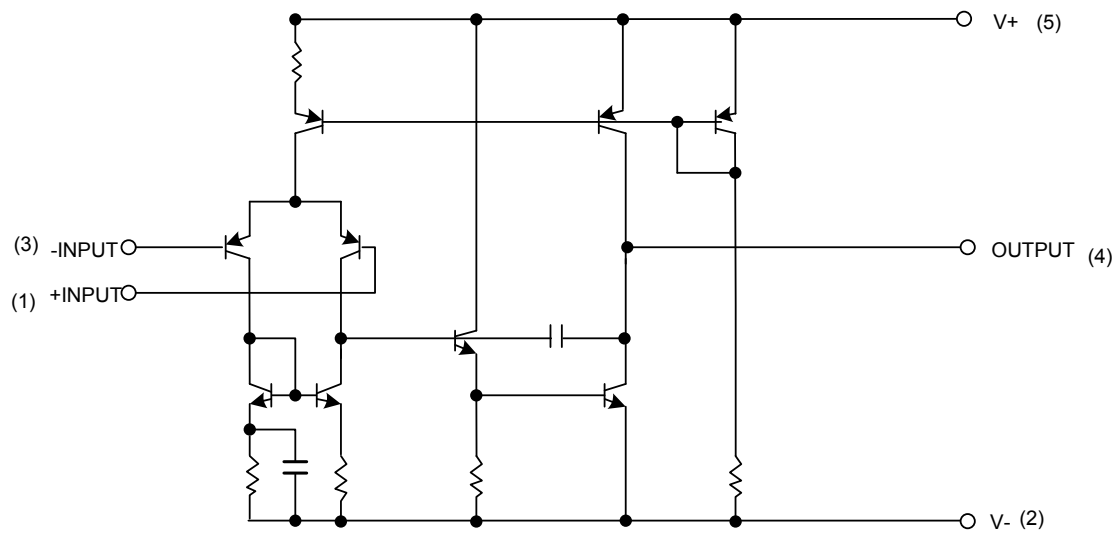

■ TEST CIRCUIT

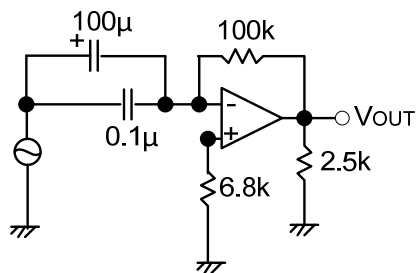

■ ABSOLUTE MAXIMUM RATINGS ($T_A=25^\circ\text{C}$, unless otherwise specified.)

PARAMETER	SYMBOL	RATINGS	UNIT
Supply Voltage	$V_+(V+/V_-)$	7(or ± 3.5)	V
Differential Input Voltage	$V_{I(DIFF)}$	± 7	V
Input Voltage	V_{IN}	± 3.5	V
Power Dissipation	P_D	200	mW
Operating Temperature	T_{OPR}	-20 ~ +75	$^\circ\text{C}$
Storage Temperature	T_{STG}	-40 ~ +125	$^\circ\text{C}$

Note Absolute maximum ratings are those values beyond which the device could be permanently damaged. Absolute maximum ratings are stress ratings only and functional device operation is not implied.

■ ELECTRICAL CHARACTERISTICS ($T_A=25^\circ\text{C}$, $V^+/V^-=\pm 2.5\text{V}$, unless otherwise specified.)

PARAMETER	SYMBOL	TEST CONDITION	MIN	TYP	MAX	UNIT
Input Offset Voltage	$V_{IN(OFF)}$	$R_S=10\text{k}\Omega$		1	6	mV
Input Offset Current	$I_{IN(OFF)}$	$I^+ - I^-$		5	200	nA
Input Bias Current	$I_{IN(BIAS)}$			100	500	nA
Large Signal Voltage Gain	G_V	$V_{OUT}=\pm 2.0\text{V}, R_L=10\text{k}\Omega$	60	80		dB
Supply Voltage Rejection Ratio	SVR	$R_S\leq 10\text{k}\Omega$	60	70		dB
Input Common Mode Voltage	$V_{IN(CM)}$		± 1.5			V
Rejection Ratio	RR	$R_S\leq 10\text{k}\Omega$	60	80		dB
Output Voltage Swing	V_{OM}	$R_L=2.5\text{k}\Omega$	± 2.0	± 2.2		V
Slew Rate	SR	$V_{IN}=\pm 1\text{Vp-p}, \text{ACL}=+1$		3		V/ μs
Operating Current	I_{OPR}		1	2	3	mA

■ TYPICAL CHARACTERISTICS

Maximum Output Voltage Swing vs. Load Resistance

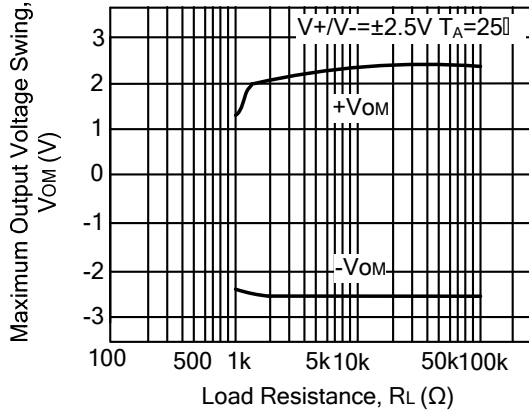

Input Noise Voltage vs. Input Resistance

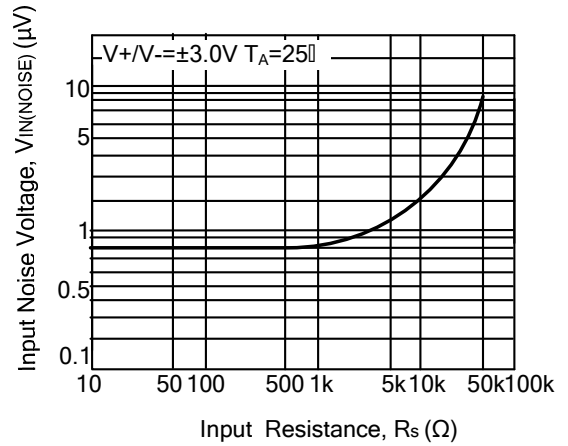

Voltage Gain, Phase vs. Frequency

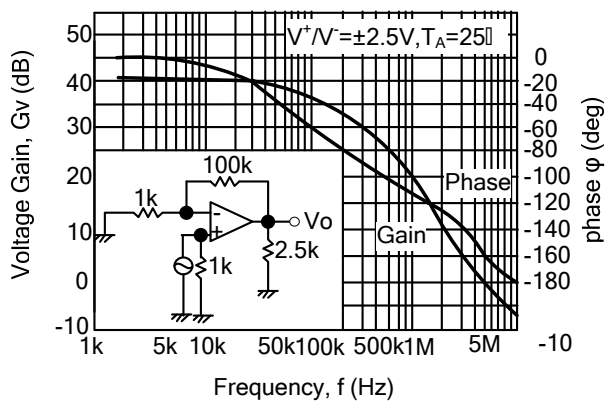

Maximum Output Voltage vs. Frequency

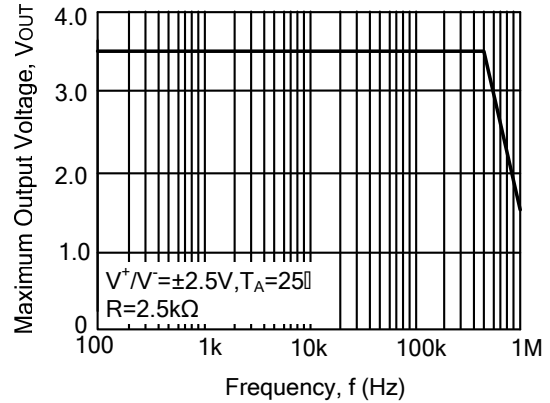

Voltage Gain vs. Frequency

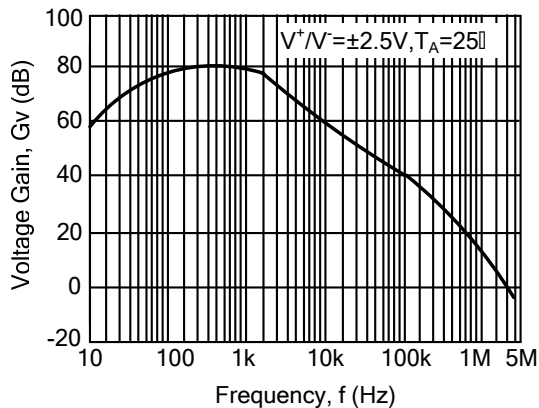

■ TYPICAL CHARACTERISTICS (Cont.)

Operating Current vs. Temperature

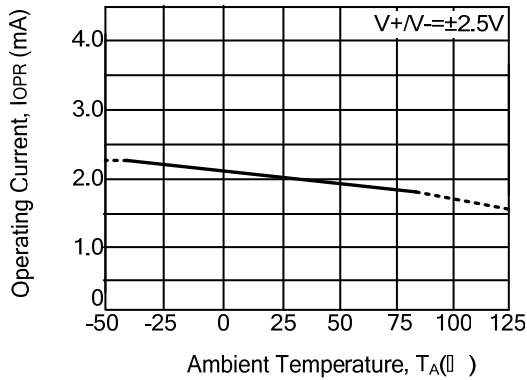

Maximum Output Voltage Swing vs. Temperature

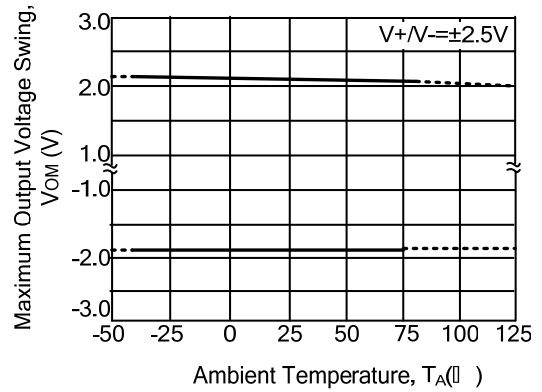

Input Offset Voltage vs. Temperature

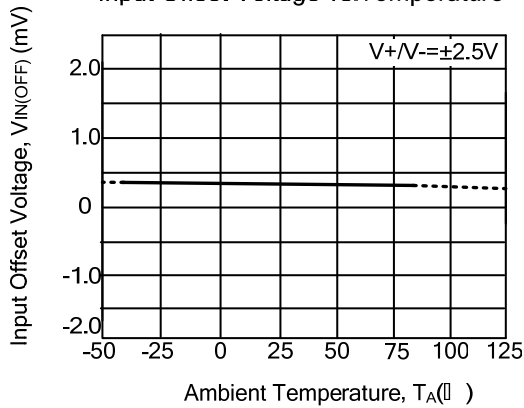

Input Bias Current vs. Temperature

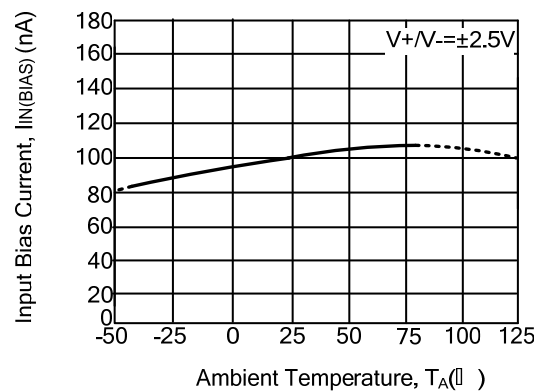

Operating Current vs. Operating Voltage

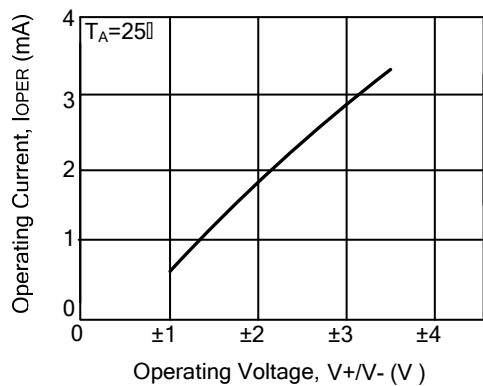

Maximum Output Voltage Swing vs. Operating Voltage

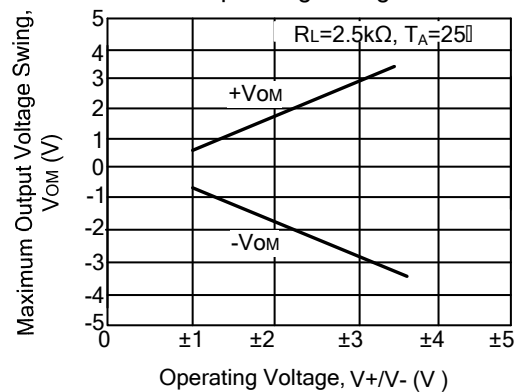

■ TYPICAL CHARACTERISTICS (Cont.)

Input Offset Voltage vs. Operating Voltage

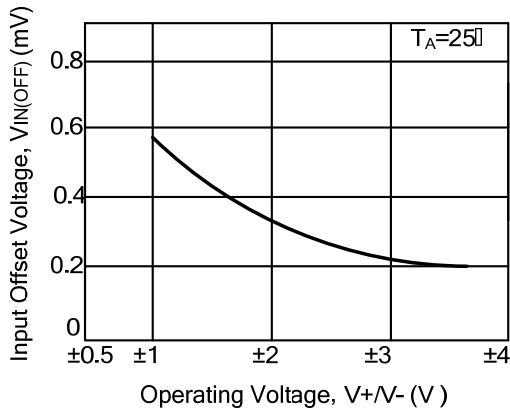

Total Harmonic Distortion vs. Output Voltage

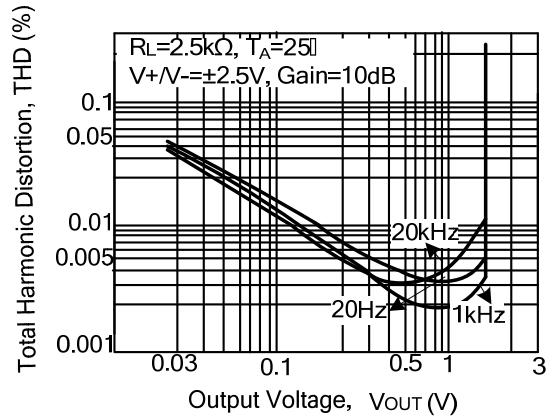

UTC assumes no responsibility for equipment failures that result from using products at values that exceed, even momentarily, rated values (such as maximum ratings, operating condition ranges, or other parameters) listed in products specifications of any and all UTC products described or contained herein. UTC products are not designed for use in life support appliances, devices or systems where malfunction of these products can be reasonably expected to result in personal injury. Reproduction in whole or in part is prohibited without the prior written consent of the copyright owner. The information presented in this document does not form part of any quotation or contract, is believed to be accurate and reliable and may be changed without notice.