

176289-1 ✓ ACTIVE

AMP Universal Power

TE Internal #: 176289-1

Rectangular Power Connectors, Housing, Receptacle, Wire-to-Wire,
12 Position, 3.96 mm [.156 in] Centerline, Wire & Cable, AMP

Universal Power

[View on TE.com >](#)



Connectors > Power Connectors > Rectangular Power > Rectangular Power Connectors

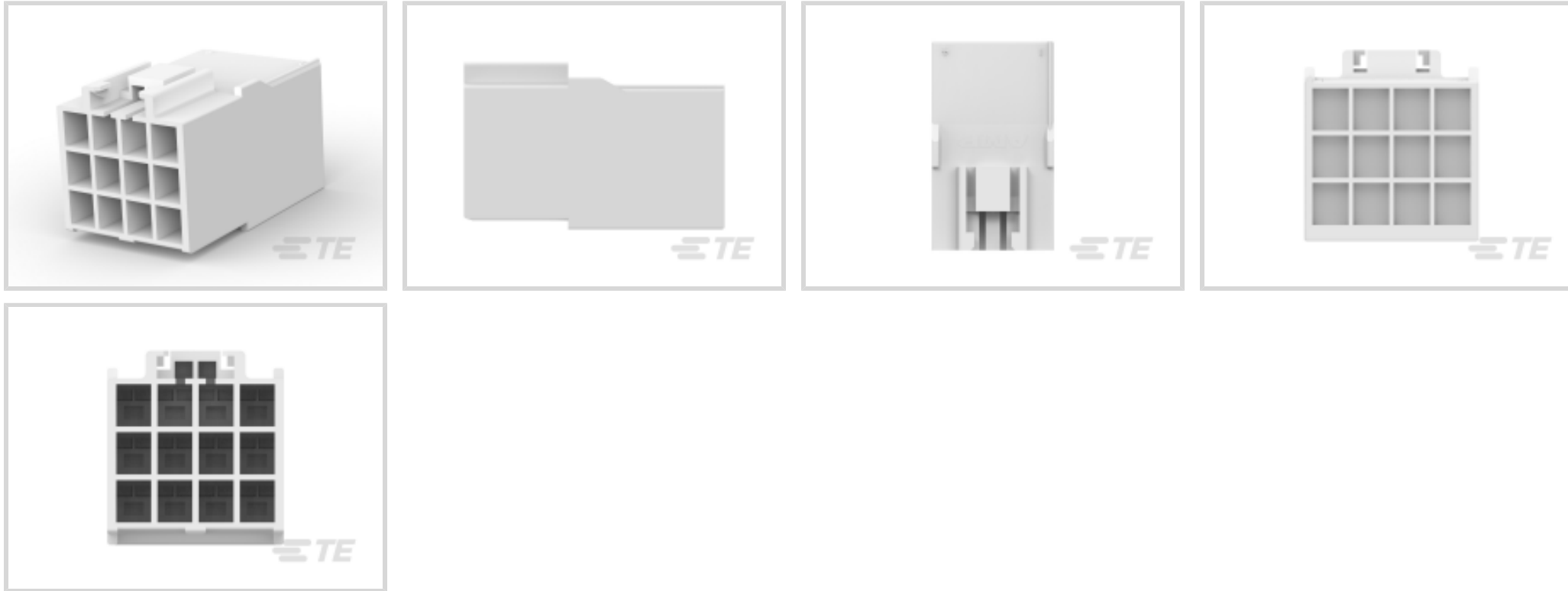

Rectangular Power Connector Type: **Housing**

Connector & Housing Type: **Receptacle**

Connector System: **Wire-to-Wire**

Number of Positions: **12**

Centerline (Pitch): **3.96 mm [.156 in]**

Features

Product Type Features

Rectangular Power Connector Type	Housing
Connector & Housing Type	Receptacle
Connector System	Wire-to-Wire
Sealable	No
Connector & Contact Terminates To	Wire & Cable

Configuration Features

Number of Positions	12
Number of Rows	3

Electrical Characteristics

Insulation Resistance	1000 MΩ
Operating Voltage	300 VAC

Contact Features

Contact Layout	Matrix
Contact Base Material	Copper Alloy



Contact Current Rating (Max)	7 A
Contact Retention Within Housing	Without
Contact Type	Tab

Termination Features

Termination Method to Wire & Cable	Crimp
------------------------------------	-------

Mechanical Attachment

Strain Relief	Without
Mating Alignment Type	Polarization
Mating Retention	With
Mating Alignment	With
Panel Mount Feature	Without
PCB Mount Retention	Without
Mating Retention Type	Latch
Connector Mounting Type	Cable Mount (Free-Hanging)

Housing Features

Centerline (Pitch)	3.96 mm [.156 in]
Housing Color	Natural
Housing Material	Nylon 6/6

Dimensions

Connector Height	17.6 mm [.69 in]
Product Length	29 mm [1.14 in]
Row-to-Row Spacing	4.6 mm [.181 in]

Usage Conditions

Operating Temperature Range	-30 – 105 °C [-22 – 221 °F]
-----------------------------	-----------------------------

Operation/Application

Circuit Application	Power & Signal
---------------------	----------------

Industry Standards

UL Flammability Rating	UL 94V-0
Glow Wire Rating	Standard Part - Not Glow Wire

Packaging Features

Packaging Quantity	500
--------------------	-----



Packaging Method

Bag

Product Compliance

[For compliance documentation, visit the product page on TE.com>](#)

EU RoHS Directive 2011/65/EU	Compliant
EU ELV Directive 2000/53/EC	Compliant
China RoHS 2 Directive MIIT Order No 32, 2016	No Restricted Materials Above Threshold
EU REACH Regulation (EC) No. 1907/2006	Current ECHA Candidate List: JUNE 2023 (235) Candidate List Declared Against: JUNE 2023 (235) Does not contain REACH SVHC
Halogen Content	Low Halogen - Br, Cl, F, I < 900 ppm per homogenous material. Also BFR/CFR/PVC Free
Solder Process Capability	Not applicable for solder process capability

Product Compliance Disclaimer

This information is provided based on reasonable inquiry of our suppliers and represents our current actual knowledge based on the information they provided. This information is subject to change. The part numbers that TE has identified as EU RoHS compliant have a maximum concentration of 0.1% by weight in homogenous materials for lead, hexavalent chromium, mercury, PBB, PBDE, DBP, BBP, DEHP, DIBP, and 0.01% for cadmium, or qualify for an exemption to these limits as defined in the Annexes of Directive 2011/65/EU (RoHS2). Finished electrical and electronic equipment products will be CE marked as required by Directive 2011/65/EU. Components may not be CE marked. Additionally, the part numbers that TE has identified as EU ELV compliant have a maximum concentration of 0.1% by weight in homogenous materials for lead, hexavalent chromium, and mercury, and 0.01% for cadmium, or qualify for an exemption to these limits as defined in the Annexes of Directive 2000/53/EC (ELV). Regarding the REACH Regulation, the information TE provides on SVHC in articles for this part number is based on the latest European Chemicals Agency (ECHA) 'Guidance on requirements for substances in articles' posted at this URL: <https://echa.europa.eu/guidance-documents/guidance-on-reach>

Compatible Parts





TE Part # 175149-2
AMP UNIVE. POWER CONN TAB CONT



TE Part # 175150-2
AMP UNIVE. POWER CONN TAB CONT



TE Part # 175153-2
U/P TAB CONT L/P



TE Part # 175154-1
UNIV POWER TAB CONT L/P



TE Part # 175154-2
U/P TAB CONT L/P



TE Part # 176278-1
UNIV POWER PLUG HSG 12P F/H



TE Part # 175149-3
AMP UNIVERSAL POWER CONN.TAB C

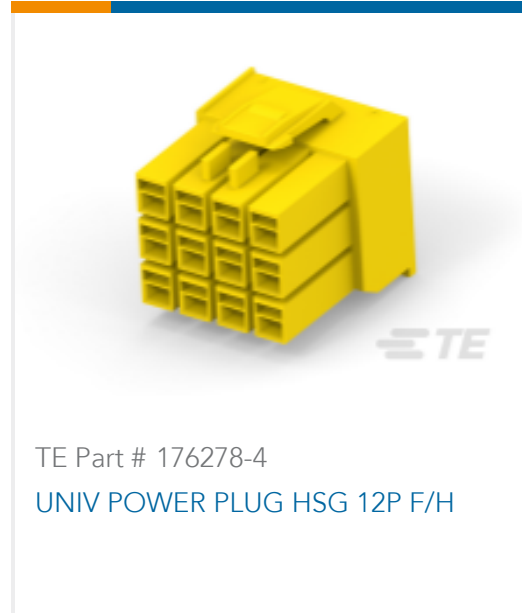

TE Part # 176278-4
UNIV POWER PLUG HSG 12P F/H

Also in the Series | AMP Universal Power

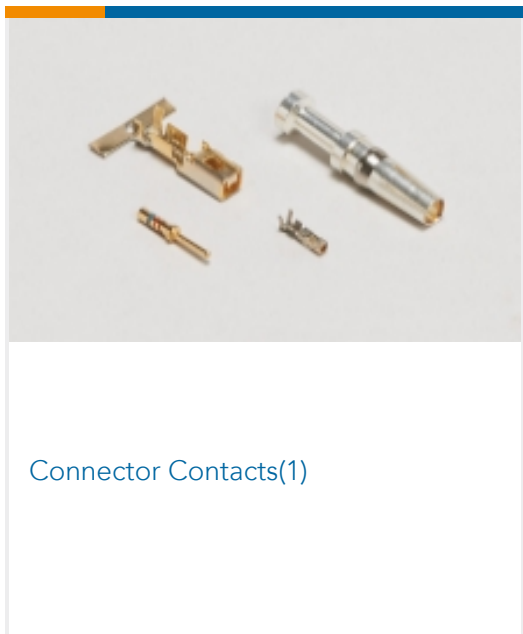

Connector Contacts(1)

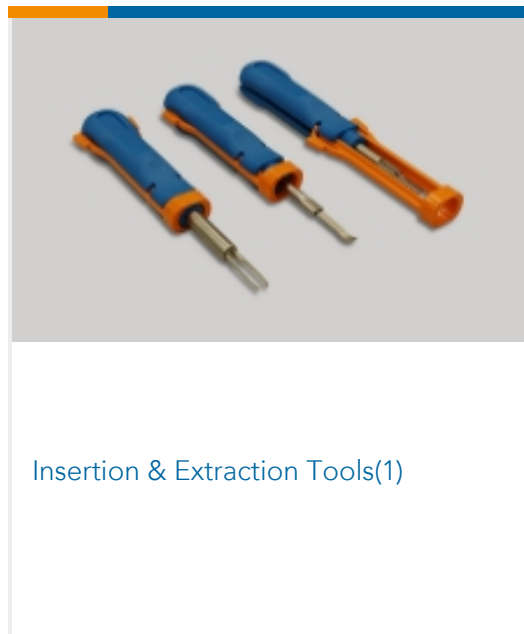

Insertion & Extraction Tools(1)

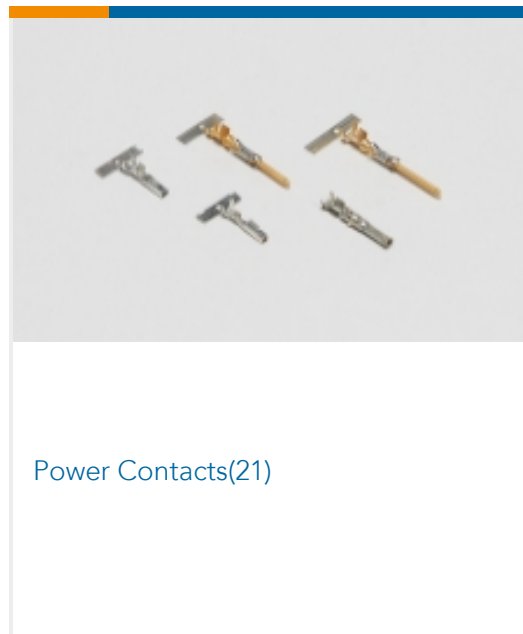

Power Contacts(21)



Rectangular Power Connectors(169)

Customers Also Bought



TE Part #176284-1
AMP UNIVERSAL POWER CAP 4P

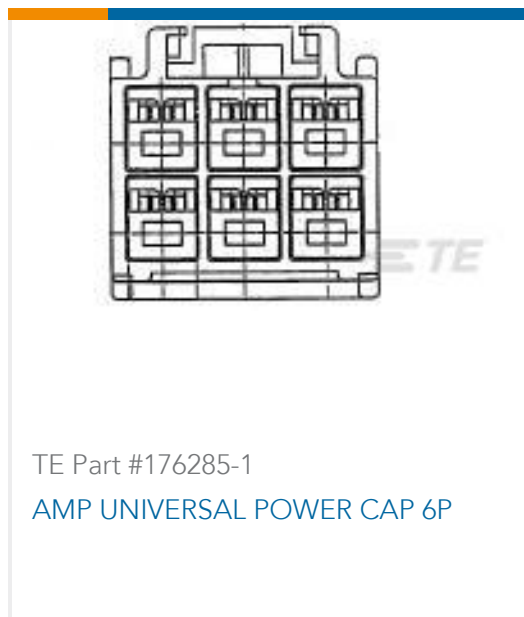

TE Part #176285-1
AMP UNIVERSAL POWER CAP 6P



TE Part #62898-1
MAG-MATE POKE-IN TAB 020 TPBR



TE Part #171637-1
MINI U-M-N-L SOCKET CONTACT



TE Part #175152-1
UNIVERSAL POWER REC



TE Part #176277-1
UNIV POWER PLUG HSG 10P F/H



TE Part #176292-1
UNIV POWER CAP HSG 2P P/MOUNT

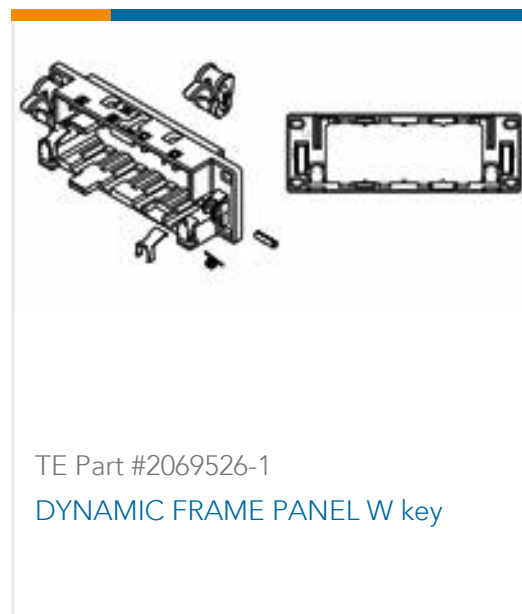

TE Part #2069526-1
DYNAMIC FRAME PANEL W key



Documents

Product Drawings

UNIV POWER CAP HSG 12P F/H

English

CAD Files

3D PDF

3D

Customer View Model

[ENG_CVM_CVM_176289-1_G.2d_dxf.zip](#)

English

Customer View Model

[ENG_CVM_CVM_176289-1_G.3d_igs.zip](#)

English

Customer View Model

[ENG_CVM_CVM_176289-1_G.3d_stp.zip](#)

English

3D PDF

English

Customer View Model

[ENG_CVM_176289-1_A.3d_igs.zip](#)

English

Customer View Model

[ENG_CVM_176289-1_A.3d_stp.zip](#)

English

Customer View Model

[ENG_CVM_176289-1_A.2d_dxf.zip](#)

English

By downloading the CAD file I accept and agree to the [Terms and Conditions](#) of use.

Product Specifications

Crimping of Universal Power Contact

English

Product Specification

Japanese

AMP Universal Power Connector

Japanese

Product Environmental Compliance

Product Compliance

English

Product Compliance

English

Instruction Sheets



AMP UNIVERSAL POWER CONNECTOR SERIES

English

Instruction Sheet (non U.S.)

English

Agency Approvals

UL Report

English