

TLC27L4, TLC27L4A, TLC27L4B, TLC27L4Y, TLC27L9 LinCMOS™ PRECISION QUAD OPERATIONAL AMPLIFIERS

SLOS053C – OCTOBER 1987 – REVISED AUGUST 1994

- **Trimmed Offset Voltage:**
TLC27L9 . . . 900 μV Max at 25°C,
 $V_{\text{DD}} = 5 \text{ V}$
- **Input Offset Voltage Drift . . . Typically**
0.1 $\mu\text{V}/\text{Month}$, Including the First 30 Days
- **Wide Range of Supply Voltages Over Specified Temperature Range:**
0°C to 70°C . . . 3 V to 16 V
-40°C to 85°C . . . 4 V to 16 V
-55°C to 125°C . . . 4 V to 16 V
- **Single-Supply Operation**
- **Common-Mode Input Voltage Range Extends Below the Negative Rail (C-Suffix, I-Suffix Types)**
- **Ultra-Low Power . . . Typically 195 μW at 25°C, $V_{\text{DD}} = 5 \text{ V}$**
- **Output Voltage Range Includes Negative Rail**
- **High Input Impedance . . . $10^{12} \Omega$ Typ**
- **ESD-Protection Circuitry**
- **Small-Outline Package Option Also Available in Tape and Reel**
- **Designed-In Latch-Up Immunity**

D, J, N, OR PW PACKAGE
(TOP VIEW)

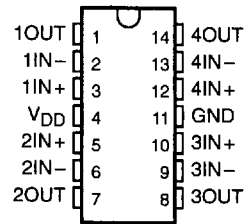

FK PACKAGE
(TOP VIEW)

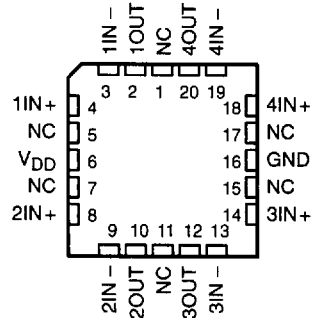

NC – No internal connection

description

The TLC27L4 and TLC27L9 quad operational amplifiers combine a wide range of input offset voltage grades with low offset voltage drift, high input impedance, extremely low power, and high gain.

These devices use Texas Instruments silicon-gate LinCMOS™ technology, which provides offset voltage stability far exceeding the stability available with conventional metal-gate processes.

The extremely high input impedance, low bias currents, and low-power consumption make these cost-effective devices ideal for high-gain, low-frequency, low-power applications. Four offset voltage grades are available (C-suffix and I-suffix types), ranging from the low-cost TLC27L4 (10 mV) to the high-precision TLC27L9 (900 μV). These advantages, in combination with good common-mode rejection and supply voltage rejection, make these devices a good choice for new state-of-the-art designs as well as for upgrading existing designs.

DISTRIBUTION OF TLC27L9
INPUT OFFSET VOLTAGE

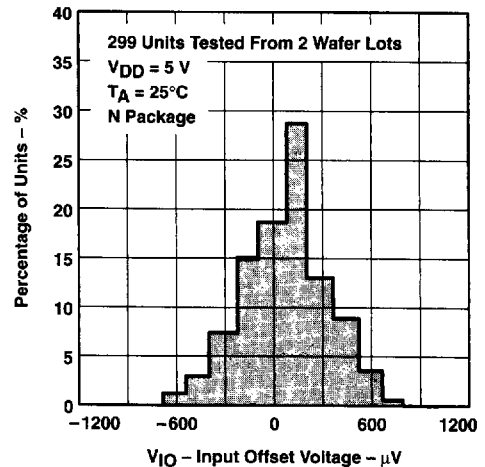

LinCMOS is a trademark of Texas Instruments Incorporated.

PRODUCTION DATA Information is current as of publication date. Products conform to specifications per the terms of Texas Instruments standard warranty. Production processing does not necessarily include testing of all parameters.

TEXAS
INSTRUMENTS

POST OFFICE BOX 655303 • DALLAS, TEXAS 75265

Copyright © 1994, Texas Instruments Incorporated

TLC27L4, TLC27L4A, TLC27L4B, TLC27L4Y, TLC27L9 LinCMOS™ PRECISION QUAD OPERATIONAL AMPLIFIERS

SLOS053C – OCTOBER 1987 – REVISED AUGUST 1994

description (continued)

In general, many features associated with bipolar technology are available on LinCMOS™ operational amplifiers, without the power penalties of bipolar technology. General applications such as transducer interfacing, analog calculations, amplifier blocks, active filters, and signal buffering are easily designed with the TLC27L4 and TLC27L9. The devices also exhibit low voltage single-supply operation and ultra-low power consumption, making them ideally suited for remote and inaccessible battery-powered applications. The common-mode input voltage range includes the negative rail.

A wide range of packaging options is available, including small-outline and chip-carrier versions for high-density system applications.

The device inputs and outputs are designed to withstand –100-mA surge currents without sustaining latch-up.

The TLC27L4 and TLC27L9 incorporate internal ESD-protection circuits that prevent functional failures at voltages up to 2000 V as tested under MIL-STD-883C, Method 3015.2; however, care should be exercised in handling these devices, as exposure to ESD may result in the degradation of the device parametric performance.

The C-suffix devices are characterized for operation from 0°C to 70°C. The I-suffix devices are characterized for operation from –40°C to 85°C. The M-suffix devices are characterized for operation from –55°C to 125°C.

AVAILABLE OPTIONS

T _A	V _{IO} max AT 25°C	PACKAGED DEVICES					CHIP FORM (Y)
		SMALL OUTLINE (D)	CHIP CARRIER (FK)	CERAMIC DIP (J)	PLASTIC DIP (N)	TSSOP (PW)	
0°C to 70°C	900 μV	TLC27L9CD	—	—	TLC27L9CN	—	—
	2 mV	TLC27L4BCD	—	—	TLC27L4BCN	—	—
	5 mV	TLC27L4ACD	—	—	TLC27L4ACN	—	—
	10 mV	TLC27L4CD	—	—	TLC27L4CN	TLC27L4CPW	TLC27L4Y
–40°C to 85°C	900 μV	TLC27L9ID	—	—	TLC27L9IN	—	—
	2 mV	TLC27L4BID	—	—	TLC27L4BIN	—	—
	5 mV	TLC27L4AID	—	—	TLC27L4AIN	—	—
	10 mV	TLC27L4ID	—	—	TLC27L4IN	—	—
–55°C to 125°C	900 μV	TLC27L9MD	TLC27L9MFK	TLC27L9MJ	TLC27L9MN	—	—
	10 mV	TLC27L4MD	TLC27L4MFK	TLC27L4MJ	TLC27L4MN	—	—

The D package is available taped and reeled. Add R suffix to the device type (e.g., TLC27L9CDR).

8961724 0106661 955



TLC27L4, TLC27L4A, TLC27L4B, TLC27L4Y, TLC27L9 LinCMOS™ PRECISION QUAD OPERATIONAL AMPLIFIERS

SLOS053C - OCTOBER 1987 - REVISED AUGUST 1994

equivalent schematic (each amplifier)

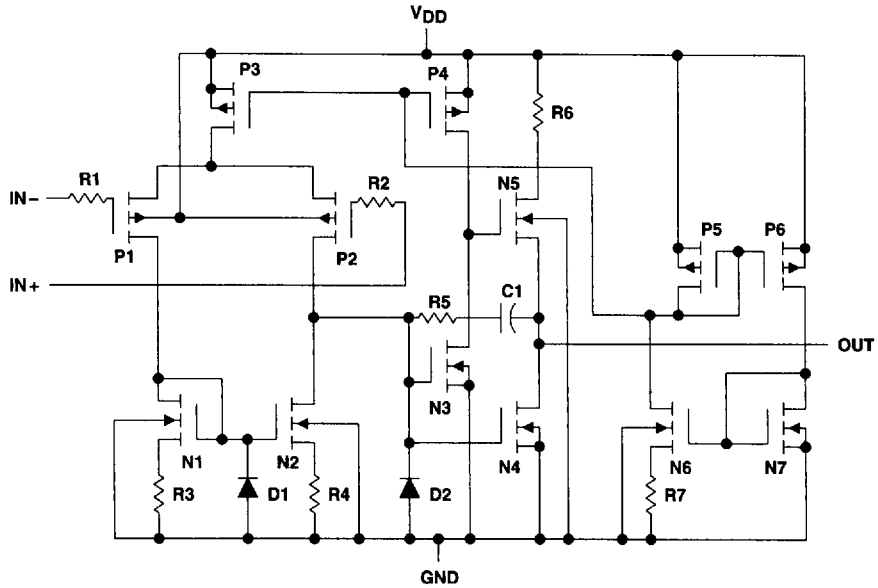

8961724 0106662 891

 **TEXAS
INSTRUMENTS**

POST OFFICE BOX 655303 • DALLAS, TEXAS 75265

3-671

TLC27L4, TLC27L4A, TLC27L4B, TLC27L4Y, TLC27L9 LinCMOS™ PRECISION QUAD OPERATIONAL AMPLIFIERS

SLOS053C - OCTOBER 1987 - REVISED AUGUST 1994

TLC27L4Y chip information

These chips, when properly assembled, display characteristics similar to the TLC27L4C. Thermal compression or ultrasonic bonding may be used on the doped-aluminum bonding pads. Chips may be mounted with conductive epoxy or a gold-silicon preform.

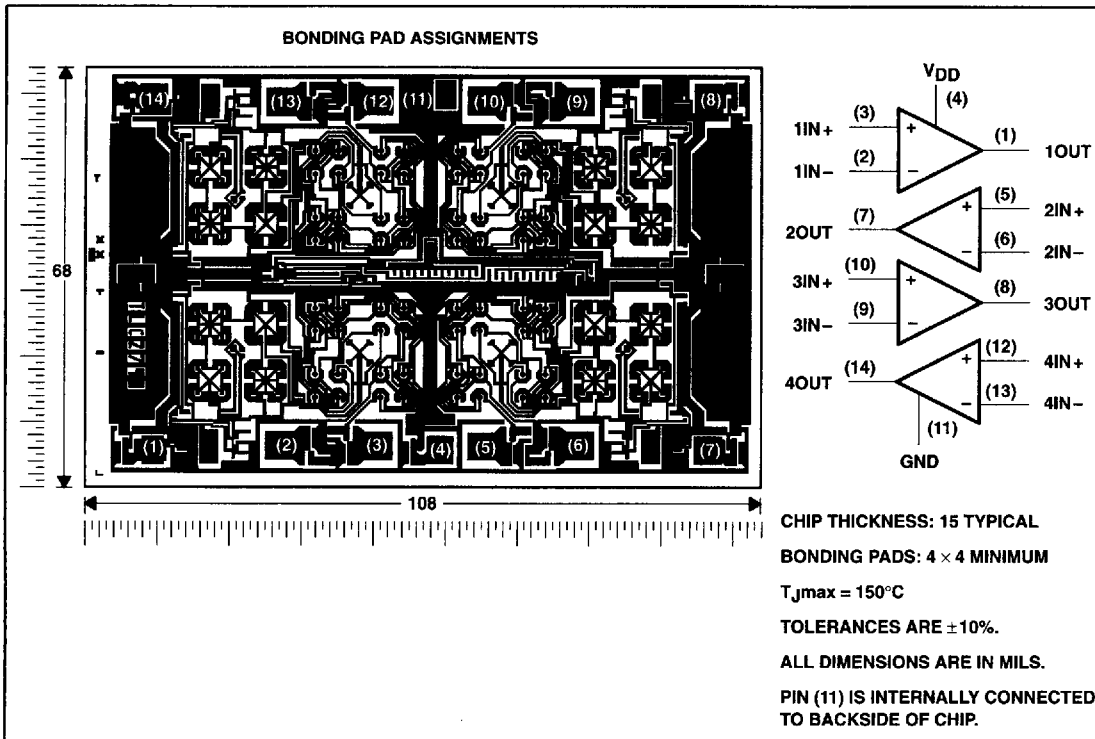

8961724 0106663 728

 **TEXAS
INSTRUMENTS**

POST OFFICE BOX 655303 • DALLAS, TEXAS 75265

TLC27L4, TLC27L4A, TLC27L4B, TLC27L4Y, TLC27L9 LinCMOS™ PRECISION QUAD OPERATIONAL AMPLIFIERS

SLOS053C – OCTOBER 1987 – REVISED AUGUST 1994

absolute maximum ratings over operating free-air temperature (unless otherwise noted)†

Supply voltage, V_{DD} (see Note 1)	18 V
Differential input voltage, V_{ID} (see Note 2)	$\pm V_{DD}$
Input voltage range, V_I (any input)	-0.3 V to V_{DD}
Input current, I_I	± 5 mA
Output current, I_O (each output)	± 30 mA
Total current into V_{DD}	45 mA
Total current out of GND	45 mA
Duration of short-circuit current at (or below) 25°C (see Note 3)	unlimited
Continuous total dissipation	See Dissipation Rating Table
Operating free-air temperature, T_A : C suffix	0°C to 70°C
I suffix	-40°C to 85°C
M suffix	-55°C to 125°C
Storage temperature range	-65°C to 150°C
Case temperature for 60 seconds: FK package	260°C
Lead temperature 1,6 mm (1/16 inch) from case for 10 seconds: D, N, or PW package	260°C
Lead temperature 1,6 mm (1/16 inch) from case for 60 seconds: J package	300°C

† Stresses beyond those listed under "absolute maximum ratings" may cause permanent damage to the device. These are stress ratings only, and functional operation of the device at these or any other conditions beyond those indicated under "recommended operating conditions" is not implied. Exposure to absolute-maximum-rated conditions for extended periods may affect device reliability.

- NOTES: 1. All voltage values, except differential voltages, are with respect to network ground.
 2. Differential voltages are at IN+ with respect to IN-.
 3. The output may be shorted to either supply. Temperature and/or supply voltages must be limited to ensure that the maximum dissipation rating is not exceeded (see application section).

DISSIPATION RATING TABLE

PACKAGE	$T_A \leq 25^\circ\text{C}$	DERATING FACTOR	$T_A = 70^\circ\text{C}$	$T_A = 85^\circ\text{C}$	$T_A = 125^\circ\text{C}$
	POWER RATING	ABOVE $T_A = 25^\circ\text{C}$	POWER RATING	POWER RATING	POWER RATING
D	950 mW	7.6 mW/°C	608 mW	494 mW	—
FK	1375 mW	11.0 mW/°C	880 mW	715 mW	275 mW
J	1375 mW	11.0 mW/°C	880 mW	715 mW	275 mW
N	1575 mW	12.6 mW/°C	1008 mW	819 mW	—
PW	700 mW	5.6 mW/°C	448 mW	—	—

recommended operating conditions

		C SUFFIX		I SUFFIX		M SUFFIX		UNIT
		MIN	MAX	MIN	MAX	MIN	MAX	
Supply voltage, V_{DD}		3	16	4	16	4	16	V
Common-mode input voltage, V_{IC}	$V_{DD} = 5$ V	-0.2	3.5	-0.2	3.5	0	3.5	V
	$V_{DD} = 10$ V	-0.2	8.5	-0.2	8.5	0	8.5	
Operating free-air temperature, T_A		0	70	-40	85	-55	125	°C

■ 8961724 0106664 664 ■



TLC27L4, TLC27L4A, TLC27L4B, TLC27L4Y, TLC27L9 LinCMOS™ PRECISION QUAD OPERATIONAL AMPLIFIERS

SLOS053C – OCTOBER 1987 – REVISED AUGUST 1994

electrical characteristics at specified free-air temperature, $V_{DD} = 5\text{ V}$ (unless otherwise noted)

PARAMETER		TEST CONDITIONS		T_A †	TLC27L4C TLC27L4AC TLC27L4BC TLC27L9C			UNIT
					MIN	TYP	MAX	
V_{IO}	Input offset voltage	TLC27L4C	$V_O = 1.4\text{ V}$, $R_S = 50\ \Omega$	$V_{IC} = 0$, $R_L = 1\text{ M}\Omega$	25°C	1.1	10	mV
					Full range		12	
		TLC27L4AC	$V_O = 1.4\text{ V}$, $R_S = 50\ \Omega$	$V_{IC} = 0$, $R_L = 1\text{ M}\Omega$	25°C	0.9	5	
					Full range		6.5	
	TLC27L4BC	$V_O = 1.4\text{ V}$, $R_S = 50\ \Omega$	$V_{IC} = 0$, $R_L = 1\text{ M}\Omega$	25°C	240	2000	μV	
				Full range		3000		
	TLC27L9C	$V_O = 1.4\text{ V}$, $R_S = 50\ \Omega$	$V_{IC} = 0$, $R_L = 1\text{ M}\Omega$	25°C	200	900		
				Full range		1500		
α_{VIO}	Average temperature coefficient of input offset voltage			25°C to 70°C	1.1		$\mu\text{V}/^\circ\text{C}$	
I_{IO}	Input offset current (see Note 4)	$V_O = 2.5\text{ V}$	$V_{IC} = 2.5\text{ V}$	25°C	0.1		pA	
				70°C	7	300		
I_{IB}	Input bias current (see Note 4)	$V_O = 2.5\text{ V}$	$V_{IC} = 2.5\text{ V}$	25°C	0.6		pA	
				70°C	40	600		
V_{ICR}	Common mode input voltage range (see Note 5)			25°C	-0.2 to 4	-0.3 to 4.2	V	
				Full range	-0.2 to 3.5		V	
V_{OH}	High-level output voltage	$V_{ID} = 100\text{ mV}$	$R_L = 1\text{ M}\Omega$	25°C	3.2	4.1	V	
				0°C	3	4.1		
				70°C	3	4.2		
V_{OL}	Low-level output voltage	$V_{ID} = -100\text{ mV}$	$I_{OL} = 0$	25°C	0	50	mV	
				0°C	0	50		
				70°C	0	50		
A_{VD}	Large-signal differential voltage amplification	$V_O = 2.5\text{ V to } 2\text{ V}$	$R_L = 1\text{ M}\Omega$	25°C	50	520	V/mV	
				0°C	50	680		
				70°C	50	380		
CMRR	Common-mode rejection ratio	$V_{IC} = V_{ICRmin}$		25°C	65	94	dB	
				0°C	60	95		
				70°C	60	95		
k_{SVR}	Supply-voltage rejection ratio ($\Delta V_{DD}/\Delta V_{IO}$)	$V_{DD} = 5\text{ V to } 10\text{ V}$	$V_O = 1.4\text{ V}$	25°C	70	97	dB	
				0°C	60	97		
				70°C	60	98		
I_{DD}	Supply current (four amplifiers)	$V_O = 2.5\text{ V}$, No load	$V_{IC} = 2.5\text{ V}$	25°C	40	68	μA	
				0°C	48	84		
				70°C	31	56		

† Full range is 0°C to 70°C.

NOTES: 4. The typical values of input bias current and input offset current below 5 pA were determined mathematically.

5. This range also applies to each input individually.

8961724 0106665 5T0



POST OFFICE BOX 655303 • DALLAS, TEXAS 75265

TLC27L4, TLC27L4A, TLC27L4B, TLC27L4Y, TLC27L9 LinCMOS™ PRECISION QUAD OPERATIONAL AMPLIFIERS

SLOS053C – OCTOBER 1987 – REVISED AUGUST 1994

electrical characteristics at specified free-air temperature, $V_{DD} = 10\text{ V}$ (unless otherwise noted)

PARAMETER		TEST CONDITIONS	T_A †	TLC27L4C TLC27L4AC TLC27L4BC TLC27L9C			UNIT
				MIN	TYP	MAX	
V_{IO}	Input offset voltage	TLC27L4C $V_O = 1.4\text{ V}$, $R_S = 50\ \Omega$, $V_{IC} = 0$, $R_L = 1\text{ M}\Omega$	25°C	1.1		10	mV
			Full range			12	
		TLC27L4AC $V_O = 1.4\text{ V}$, $R_S = 50\ \Omega$, $V_{IC} = 0$, $R_L = 1\text{ M}\Omega$	25°C	0.9		5	mV
			Full range			6.5	
		TLC27L4BC $V_O = 1.4\text{ V}$, $R_S = 50\ \Omega$, $V_{IC} = 0$, $R_L = 1\text{ M}\Omega$	25°C	260	2000		μV
			Full range			3000	
		TLC27L9C $V_O = 1.4\text{ V}$, $R_S = 50\ \Omega$, $V_{IC} = 0$, $R_L = 1\text{ M}\Omega$	25°C	210	1200		μV
			Full range			1900	
α_{VIO}	Average temperature coefficient of input offset voltage		25°C to 70°C	1		$\mu\text{V}/^\circ\text{C}$	
I_{IO}	Input offset current (see Note 4)	$V_O = 5\text{ V}$, $V_{IC} = 5\text{ V}$	25°C	0.1		pA	
			70°C	7	300		
I_{IB}	Input bias current (see Note 4)	$V_O = 5\text{ V}$, $V_{IC} = 5\text{ V}$	25°C	0.7		pA	
			70°C	50	600		
V_{ICR}	Common-mode input voltage range (see Note 5)		25°C	-0.2 to 9	-0.3 to 9.2	V	
			Full range	-0.2 to 8.5		V	
V_{OH}	High-level output voltage	$V_{ID} = 100\text{ mV}$, $R_L = 1\text{ M}\Omega$	25°C	8	8.9	V	
			0°C	7.8	8.9		
			70°C	7.8	8.9		
V_{OL}	Low-level output voltage	$V_{ID} = -100\text{ mV}$, $I_{OL} = 0$	25°C	0	50	mV	
			0°C	0	50		
			70°C	0	50		
A_{VD}	Large-signal differential voltage amplification	$V_O = 1\text{ V to }6\text{ V}$, $R_L = 1\text{ M}\Omega$	25°C	50	870	V/mV	
			0°C	50	1020		
			70°C	50	660		
CMRR	Common-mode rejection ratio	$V_{IC} = V_{ICRmin}$	25°C	65	97	dB	
			0°C	60	97		
			70°C	60	97		
k_{SVR}	Supply-voltage rejection ratio ($\Delta V_{DD}/\Delta V_{IO}$)	$V_{DD} = 5\text{ V to }10\text{ V}$, $V_O = 1.4\text{ V}$	25°C	70	97	dB	
			0°C	60	97		
			70°C	60	98		
I_{DD}	Supply current (four amplifiers)	$V_O = 5\text{ V}$, No load $V_{IC} = 5\text{ V}$	25°C	57	92	μA	
			0°C	72	132		
			70°C	44	80		

† Full range is 0°C to 70°C.

- NOTES: 4. The typical values of input bias current and input offset current below 5 pA were determined mathematically.
5. This range also applies to each input individually.

8961724 0106666 437



POST OFFICE BOX 655303 • DALLAS, TEXAS 75265

TLC27L4, TLC27L4A, TLC27L4B, TLC27L4Y, TLC27L9 LinCMOS™ PRECISION QUAD OPERATIONAL AMPLIFIERS

SLOS053C – OCTOBER 1987 – REVISED AUGUST 1994

electrical characteristics at specified free-air temperature, $V_{DD} = 5\text{ V}$ (unless otherwise noted)

PARAMETER		TEST CONDITIONS		T_A †	TLC27L4I TLC27L4AI TLC27L4BI TLC27L9I			UNIT
					MIN	TYP	MAX	
V_{IO}	Input offset voltage	TLC27L4I	$V_O = 1.4\text{ V}$, $R_S = 50\ \Omega$	$V_{IC} = 0$, $R_L = 1\text{ M}\Omega$	25°C	1.1	10	mV
					Full range		13	
		TLC27L4AI	$V_O = 1.4\text{ V}$, $R_S = 50\ \Omega$	$V_{IC} = 0$, $R_L = 1\text{ M}\Omega$	25°C	0.9	5	mV
					Full range		7	
		TLC27L4BI	$V_O = 1.4\text{ V}$, $R_S = 50\ \Omega$	$V_{IC} = 0$, $R_L = 1\text{ M}\Omega$	25°C	240	2000	μV
					Full range		3500	
		TLC27L9I	$V_O = 1.4\text{ V}$, $R_S = 50\ \Omega$	$V_{IC} = 0$, $R_L = 1\text{ M}\Omega$	25°C	200	900	μV
					Full range		2000	
α_{VIO}	Average temperature coefficient of input offset voltage			25°C to 85°C	1.1		$\mu\text{V}/^\circ\text{C}$	
I_{IO}	Input offset current (see Note 4)	$V_O = 2.5\text{ V}$	$V_{IC} = 2.5\text{ V}$	25°C	0.1		pA	
				85°C	24	1000		
I_{IB}	Input bias current (see Note 4)	$V_O = 2.5\text{ V}$	$V_{IC} = 2.5\text{ V}$	25°C	0.6		pA	
				85°C	200	2000		
V_{ICR}	Common-mode input voltage range (see Note 5)			25°C	-0.2 to 4	-0.3 to 4.2	V	
				Full range	-0.2 to 3.5		V	
V_{OH}	High-level output voltage	$V_{ID} = 100\text{ mV}$	$R_L = 1\text{ M}\Omega$	25°C	3.2	4.1	V	
				-40°C	3	4.1		
				85°C	3	4.2		
V_{OL}	Low-level output voltage	$V_{ID} = -100\text{ mV}$	$I_{OL} = 0$	25°C	0	50	mV	
				-40°C	0	50		
				85°C	0	50		
A_{VD}	Large-signal differential voltage amplification	$V_O = 0.25\text{ V to } 2\text{ V}$	$R_L = 1\text{ M}\Omega$	25°C	50	480	V/mV	
				-40°C	50	900		
				85°C	50	330		
CMRR	Common-mode rejection ratio	$V_{IC} = V_{ICRmin}$		25°C	65	94	dB	
				-40°C	60	95		
				85°C	60	95		
k_{SVR}	Supply-voltage rejection ratio ($\Delta V_{DD}/\Delta V_{IO}$)	$V_{DD} = 5\text{ V to } 10\text{ V}$	$V_O = 1.4\text{ V}$	25°C	70	97	dB	
				-40°C	60	97		
				85°C	60	98		
I_{DD}	Supply current (four amplifiers)	$V_O = 2.5\text{ V}$, No load	$V_{IC} = 2.5\text{ V}$	25°C	39	68	μA	
				-40°C	62	108		
				85°C	29	52		

† Full range is -40°C to 85°C.

- NOTES: 4. The typical values of input bias current and input offset current below 5 pA were determined mathematically.
5. This range also applies to each input individually.

8961724 0106667 373



TLC27L4, TLC27L4A, TLC27L4B, TLC27L4Y, TLC27L9 LinCMOS™ PRECISION QUAD OPERATIONAL AMPLIFIERS

SLOS053C – OCTOBER 1987 – REVISED AUGUST 1994

electrical characteristics at specified free-air temperature, $V_{DD} = 10\text{ V}$ (unless otherwise noted)

PARAMETER		TEST CONDITIONS		T_A †	TLC27L4I TLC27L4AI TLC27L4BI TLC27L9I			UNIT
					MIN	TYP	MAX	
V_{IO}	Input offset voltage	TLC27L4I	$V_O = 1.4\text{ V}$, $R_S = 50\ \Omega$	$V_{IC} = 0$, $R_L = 1\text{ M}\Omega$	25°C	1.1	10	mV
					Full range		13	
		TLC27L4AI	$V_O = 1.4\text{ V}$, $R_S = 50\ \Omega$	$V_{IC} = 0$, $R_L = 1\text{ M}\Omega$	25°C	0.9	5	mV
					Full range		7	
		TLC27L4BI	$V_O = 1.4\text{ V}$, $R_S = 50\ \Omega$	$V_{IC} = 0$, $R_L = 1\text{ M}\Omega$	25°C	260	2000	μV
					Full range		3500	
		TLC27L9I	$V_O = 1.4\text{ V}$, $R_S = 50\ \Omega$	$V_{IC} = 0$, $R_L = 1\text{ M}\Omega$	25°C	210	1200	μV
					Full range		2900	
α_{VIO}	Average temperature coefficient of input offset voltage			25°C to 85°C	1		$\mu\text{V}/^\circ\text{C}$	
I_{IO}	Input offset current (see Note 4)	$V_O = 5\text{ V}$	$V_{IC} = 5\text{ V}$	25°C	0.1		pA	
				85°C	26	1000		
I_{IB}	Input bias current (see Note 4)	$V_O = 5\text{ V}$	$V_{IC} = 5\text{ V}$	25°C	0.7		pA	
				85°C	220	2000		
V_{ICR}	Common-mode input voltage range (see Note 5)			25°C	-0.2 to 9	-0.3 to 9.2	V	
				Full range	-0.2 to 8.5		V	
V_{OH}	High-level output voltage	$V_{ID} = 100\text{ mV}$	$R_L = 1\text{ M}\Omega$	25°C	8	8.9	V	
				-40°C	7.8	8.9		
				85°C	7.8	8.9		
V_{OL}	Low-level output voltage	$V_{ID} = -100\text{ mV}$	$I_{OL} = 0$	25°C	0	50	mV	
				-40°C	0	50		
				85°C	0	50		
A_{VD}	Large-signal differential voltage amplification	$V_O = 1\text{ V to }6\text{ V}$	$R_L = 1\text{ M}\Omega$	25°C	50	800	V/mV	
				-40°C	50	1550		
				85°C	50	585		
CMRR	Common-mode rejection ratio	$V_{IC} = V_{ICRmin}$		25°C	65	97	dB	
				-40°C	60	97		
				85°C	60	98		
k_{SVR}	Supply-voltage rejection ratio ($\Delta V_{DD}/\Delta V_{IO}$)	$V_{DD} = 5\text{ V to }10\text{ V}$	$V_O = 1.4\text{ V}$	25°C	70	97	dB	
				-40°C	60	97		
				85°C	60	98		
I_{DD}	Supply current (four amplifiers)	$V_O = 5\text{ V}$, No load	$V_{IC} = 5\text{ V}$	25°C	57	92	μA	
				-40°C	98	172		
				85°C	40	72		

† Full range is -40°C to 85°C.

NOTES: 4. The typical values of input bias current and input offset current below 5 pA were determined mathematically.

5. This range also applies to each input individually.

8961724 0106668 20T



POST OFFICE BOX 655303 • DALLAS, TEXAS 75265

TLC27L4, TLC27L4A, TLC27L4B, TLC27L4Y, TLC27L9 LinCMOS™ PRECISION QUAD OPERATIONAL AMPLIFIERS

SLOS053C – OCTOBER 1987 – REVISED AUGUST 1994

electrical characteristics at specified free-air temperature, $V_{DD} = 5\text{ V}$ (unless otherwise noted)

PARAMETER		TEST CONDITIONS		T_A †	TLC27L4M TLC27L9M			UNIT
					MIN	TYP	MAX	
V_{IO}	Input offset voltage	TLC27L4M	$V_O = 1.4\text{ V}$, $R_S = 50\ \Omega$	$V_{IC} = 0$, $R_L = 1\text{ M}\Omega$	25°C	1.1	10	mV
					Full range		12	
	TLC27L9M	$V_O = 1.4\text{ V}$, $R_S = 50\ \Omega$	$V_{IC} = 0$, $R_L = 1\text{ M}\Omega$	25°C	200	900	μV	
				Full range		3750		
α_{VIO}	Average temperature coefficient of input offset voltage			25°C to 125°C	1.4		$\mu\text{V}/^\circ\text{C}$	
I_{IO}	Input offset current (see Note 4)	$V_O = 2.5\text{ V}$	$V_{IC} = 2.5\text{ V}$	25°C	0.1		pA	
				125°C	1.4	15	nA	
I_{IB}	Input bias current (see Note 4)	$V_O = 2.5\text{ V}$	$V_{IC} = 2.5\text{ V}$	25°C	0.6		pA	
				125°C	9	35	nA	
V_{ICR}	Common-mode input voltage range (see Note 5)			25°C	-0.2 to 4	-0.3 to 4.2	V	
				Full range	-0.2 to 3.5		V	
V_{OH}	High-level output voltage	$V_{ID} = 100\text{ mV}$	$R_L = 1\text{ M}\Omega$	25°C	3.2	4.1	V	
				-55°C	3	4.1		
				125°C	3	4.2		
V_{OL}	Low-level output voltage	$V_{ID} = -100\text{ mV}$	$I_{OL} = 0$	25°C	0	50	mV	
				-55°C	0	50		
				125°C	0	50		
A_{VD}	Large-signal differential voltage amplification	$V_O = 0.25\text{ V to }2\text{ V}$	$R_L = 1\text{ M}\Omega$	25°C	50	480	V/mV	
				-55°C	25	950		
				125°C	25	200		
CMRR	Common-mode rejection ratio	$V_{IC} = V_{ICRmin}$		25°C	65	94	dB	
				-55°C	60	95		
				125°C	60	85		
k_{SVR}	Supply-voltage rejection ratio ($\Delta V_{DD}/\Delta V_{IO}$)	$V_{DD} = 5\text{ V to }10\text{ V}$	$V_O = 1.4\text{ V}$	25°C	70	97	dB	
				-55°C	60	97		
				125°C	60	98		
I_{DD}	Supply current (four amplifiers)	$V_O = 2.5\text{ V}$, No load	$V_{IC} = 2.5\text{ V}$	25°C	39	68	μA	
				-55°C	69	120		
				125°C	27	48		

† Full range is -55°C to 125°C.

- NOTES: 4. The typical values of input bias current and input offset current below 5 pA were determined mathematically.
5. This range also applies to each input individually.

8961724 0106669 146



TLC27L4, TLC27L4A, TLC27L4B, TLC27L4Y, TLC27L9 LinCMOS™ PRECISION QUAD OPERATIONAL AMPLIFIERS

SLOS053C – OCTOBER 1987 – REVISED AUGUST 1994

electrical characteristics at specified free-air temperature, $V_{DD} = 10\text{ V}$ (unless otherwise noted)

PARAMETER		TEST CONDITIONS		T_A †	TLC27L4M TLC27L9M			UNIT
					MIN	TYP	MAX	
V_{IO}	Input offset voltage	TLC27L4M	$V_O = 1.4\text{ V}$, $R_S = 50\ \Omega$	$V_{IC} = 0$, $R_L = 1\text{ M}\Omega$	25°C	1.1	10	mV
					Full range		12	
		TLC27L9M	$V_O = 1.4\text{ V}$, $R_S = 50\ \Omega$	$V_{IC} = 0$, $R_L = 1\text{ M}\Omega$	25°C	210	1200	μV
					Full range		4300	
α_{VIO}	Average temperature coefficient of input offset voltage			25°C to 125°C	1.4		$\mu\text{V}/^\circ\text{C}$	
I_{IO}	Input offset current (see Note 4)	$V_O = 5\text{ V}$	$V_{IC} = 5\text{ V}$	25°C	0.1		pA	
				125°C	1.8	15	nA	
I_{IB}	Input bias current (see Note 4)	$V_O = 5\text{ V}$	$V_{IC} = 5\text{ V}$	25°C	0.7		pA	
				125°C	10	35	nA	
V_{ICR}	Common-mode input voltage range (see Note 5)			25°C	0 to 9	-0.3 to 9.2	V	
				Full range	0 to 8.5		V	
V_{OH}	High-level output voltage	$V_{ID} = 100\text{ mV}$	$R_L = 1\text{ M}\Omega$	25°C	8	8.9	V	
				-55°C	7.8	8.8		
				125°C	7.8	9		
V_{OL}	Low-level output voltage	$V_{ID} = -100\text{ mV}$	$I_{OL} = 0$	25°C	0	50	mV	
				-55°C	0	50		
				125°C	0	50		
A_{VD}	Large-signal differential voltage amplification	$V_O = 1\text{ V to }6\text{ V}$	$R_L = 1\text{ M}\Omega$	25°C	50	800	V/mV	
				-55°C	25	1750		
				125°C	25	380		
CMRR	Common-mode rejection ratio	$V_{IC} = V_{ICRmin}$		25°C	65	97	dB	
				-55°C	60	97		
				125°C	60	91		
k_{SVR}	Supply-voltage rejection ratio ($\Delta V_{DD}/\Delta V_{IO}$)	$V_{DD} = 5\text{ V to }10\text{ V}$	$V_O = 1.4\text{ V}$	25°C	70	97	dB	
				-55°C	60	97		
				125°C	60	98		
I_{DD}	Supply current (four amplifiers)	$V_O = 5\text{ V}$, No load	$V_{IC} = 5\text{ V}$	25°C	57	92	μA	
				-55°C	111	192		
				125°C	35	60		

† Full range is -55°C to 125°C.

- NOTES: 4. The typical values of input bias current and Input offset current below 5 pA were determined mathematically.
5. This range also applies to each input individually.

8961724 0106670 968



POST OFFICE BOX 655303 • DALLAS, TEXAS 75265

TLC27L4, TLC27L4A, TLC27L4B, TLC27L4Y, TLC27L9

LinCMOS™ PRECISION QUAD OPERATIONAL AMPLIFIERS

SLOS053C – OCTOBER 1987 – REVISED AUGUST 1994

electrical characteristics at specified free-air temperature, $V_{DD} = 5\text{ V}$, $T_A = 25^\circ\text{C}$ (unless otherwise noted)

PARAMETER	TEST CONDITIONS	TLC27L4Y			UNIT
		MIN	TYP	MAX	
V_{IO} Input offset voltage	$V_O = 1.4\text{ V}$, $R_S = 50\ \Omega$, $V_{IC} = 0$, $R_L = 1\text{ M}\Omega$		1.1	10	mV
αV_{IO} Average temperature coefficient of input offset voltage	$T_A = 25^\circ\text{C}$ to 70°C		1.1		$\mu\text{V}/^\circ\text{C}$
I_{IO} Input offset current (see Note 4)	$V_O = 2.5\text{ V}$, $V_{IC} = 2.5\text{ V}$		0.1		pA
I_{IB} Input bias current (see Note 4)	$V_O = 2.5\text{ V}$, $V_{IC} = 2.5\text{ V}$		0.6		pA
V_{ICR} Common-mode input voltage range (see Note 5)		-0.2 to 4	-0.3 to 4.2		V
V_{OH} High-level output voltage	$V_{ID} = 100\text{ mV}$, $R_L = 1\text{ M}\Omega$	3.2	4.1		V
V_{OL} Low-level output voltage	$V_{ID} = -100\text{ mV}$, $I_{OL} = 0$		0	50	mV
A_{VD} Large-signal differential voltage amplification	$V_O = 0.25\text{ V}$ to 2 V , $R_L = 1\text{ M}\Omega$	50	520		V/mV
CMRR Common-mode rejection ratio	$V_{IC} = V_{ICRmin}$	65	94		dB
k_{SVR} Supply-voltage rejection ratio ($\Delta V_{DD}/\Delta V_{IO}$)	$V_{DD} = 5\text{ V}$ to 10 V , $V_O = 1.4\text{ V}$	70	97		dB
I_{DD} Supply current (four amplifiers)	$V_O = 2.5\text{ V}$, No load $V_{IC} = 2.5\text{ V}$		40	68	μA

electrical characteristics at specified free-air temperature, $V_{DD} = 10\text{ V}$, $T_A = 25^\circ\text{C}$ (unless otherwise noted)

PARAMETER	TEST CONDITIONS	TLC27L4Y			UNIT
		MIN	TYP	MAX	
V_{IO} Input offset voltage	$V_O = 1.4\text{ V}$, $R_S = 50\ \Omega$, $V_{IC} = 0$, $R_L = 1\text{ M}\Omega$		1.1	10	mV
αV_{IO} Average temperature coefficient of input offset voltage	$T_A = 25^\circ\text{C}$ to 70°C		1		$\mu\text{V}/^\circ\text{C}$
I_{IO} Input offset current (see Note 4)	$V_O = 5\text{ V}$, $V_{IC} = 5\text{ V}$		0.1		pA
I_{IB} Input bias current (see Note 4)	$V_O = 5\text{ V}$, $V_{IC} = 5\text{ V}$		0.7		pA
V_{ICR} Common-mode input voltage range (see Note 5)		-0.2 to 9	-0.3 to 9.2		V
V_{OH} High-level output voltage	$V_{ID} = 100\text{ mV}$, $R_L = 1\text{ M}\Omega$	8	8.9		V
V_{OL} Low-level output voltage	$V_{ID} = -100\text{ mV}$, $I_{OL} = 0$		0	50	mV
A_{VD} Large-signal differential voltage amplification	$V_O = 1\text{ V}$ to 6 V , $R_L = 1\text{ M}\Omega$	50	870		V/mV
CMRR Common-mode rejection ratio	$V_{IC} = V_{ICRmin}$	65	97		dB
k_{SVR} Supply-voltage rejection ratio ($\Delta V_{DD}/\Delta V_{IO}$)	$V_{DD} = 5\text{ V}$ to 10 V , $V_O = 1.4\text{ V}$	70	97		dB
I_{DD} Supply current (four amplifiers)	$V_O = 5\text{ V}$, No load $V_{IC} = 5\text{ V}$		57	92	μA

NOTES: 4. The typical values of input bias current and input offset current below 5 pA were determined mathematically.
5. This range also applies to each input individually.

8961724 0106671 8T4



TLC27L4, TLC27L4A, TLC27L4B, TLC27L4Y, TLC27L9 LinCMOS™ PRECISION QUAD OPERATIONAL AMPLIFIERS

SLOS053C – OCTOBER 1987 – REVISED AUGUST 1994

operating characteristics at specified free-air temperature, $V_{DD} = 5\text{ V}$

PARAMETER	TEST CONDITIONS		T_A	TLC27L4C TLC27L4AC TLC27L4BC TLC27L9C			UNIT
				MIN	TYP	MAX	
SR Slew rate at unity gain	$R_L = 1\text{ M}\Omega$, $C_L = 20\text{ pF}$, See Figure 1	$V_{Ipp} = 1\text{ V}$	25°C	0.03			V/ μ s
			0°C	0.04			
			70°C	0.03			
		$V_{Ipp} = 2.5\text{ V}$	25°C	0.03			
			0°C	0.03			
			70°C	0.02			
V_n Equivalent input noise voltage	$f = 1\text{ kHz}$, See Figure 2	$R_S = 20\ \Omega$	25°C	70			nV/ $\sqrt{\text{Hz}}$
BOM Maximum output-swing bandwidth	$V_O = V_{OH}$, $R_L = 1\text{ M}\Omega$, $C_L = 20\text{ pF}$, See Figure 1		25°C	5			kHz
			0°C	6			
			70°C	4.5			
B ₁ Unity-gain bandwidth	$V_I = 10\text{ mV}$, See Figure 3	$C_L = 20\text{ pF}$	25°C	85			kHz
			0°C	100			
			70°C	65			
ϕ_m Phase margin	$V_I = 10\text{ mV}$, $C_L = 20\text{ pF}$,	$f = B_1$, See Figure 3	25°C	34°			
			0°C	36°			
			70°C	30°			

operating characteristics at specified free-air temperature, $V_{DD} = 10\text{ V}$

PARAMETER	TEST CONDITIONS		T_A	TLC27L4C TLC27L4AC TLC27L4BC TLC27L9C			UNIT
				MIN	TYP	MAX	
SR Slew rate at unity gain	$R_L = 1\text{ M}\Omega$, $C_L = 20\text{ pF}$, See Figure 1	$V_{Ipp} = 1\text{ V}$	25°C	0.05			V/ μ s
			0°C	0.05			
			70°C	0.04			
		$V_{Ipp} = 5.5\text{ V}$	25°C	0.04			
			0°C	0.05			
			70°C	0.04			
V_n Equivalent input noise voltage	$f = 1\text{ kHz}$, See Figure 2	$R_S = 20\ \Omega$	25°C	70			nV/ $\sqrt{\text{Hz}}$
BOM Maximum output-swing bandwidth	$V_O = V_{OH}$, $R_L = 1\text{ M}\Omega$, $C_L = 20\text{ pF}$, See Figure 1		25°C	1			kHz
			0°C	1.3			
			70°C	0.9			
B ₁ Unity-gain bandwidth	$V_I = 10\text{ mV}$, See Figure 3	$C_L = 20\text{ pF}$	25°C	110			kHz
			0°C	125			
			70°C	90			
ϕ_m Phase margin	$V_I = 10\text{ mV}$, $C_L = 20\text{ pF}$,	$f = B_1$, See Figure 3	25°C	38°			
			0°C	40°			
			70°C	34°			

8961724 0106672 730



TLC27L4, TLC27L4A, TLC27L4B, TLC27L4Y, TLC27L9 LinCMOS™ PRECISION QUAD OPERATIONAL AMPLIFIERS

SLOS053C – OCTOBER 1987 – REVISED AUGUST 1994

operating characteristics at specified free-air temperature, $V_{DD} = 5\text{ V}$

PARAMETER	TEST CONDITIONS		T_A	TLC27L4I TLC27L4AI TLC27L4BI TLC27L9I			UNIT
				MIN	TYP	MAX	
SR Slew rate at unity gain	$R_L = 1\text{ M}\Omega$, $C_L = 20\text{ pF}$, See Figure 1	$V_{I\text{PP}} = 1\text{ V}$	25°C	0.03			V/ μs
			-40°C	0.04			
			85°C	0.03			
		$V_{I\text{PP}} = 2.5\text{ V}$	25°C	0.03			
			-40°C	0.04			
			85°C	0.02			
V_n Equivalent input noise voltage	$f = 1\text{ Hz}$, See Figure 2	$R_S = 20\ \Omega$	25°C	70			nV/ $\sqrt{\text{Hz}}$
B_{OM} Maximum output-swing bandwidth	$V_O = V_{\text{OH}}$, $R_L = 1\text{ M}\Omega$,	$C_L = 20\text{ pF}$, See Figure 1	25°C	5			kHz
			-40°C	7			
			85°C	4			
B_1 Unity-gain bandwidth	$V_I = 10\text{ mV}$, See Figure 3	$C_L = 20\text{ pF}$,	25°C	85			kHz
			-40°C	130			
			85°C	55			
ϕ_m Phase margin	$V_I = 10\text{ mV}$, $C_L = 20\text{ pF}$,	$f = B_1$, See Figure 3	25°C	34°			
			-40°C	38°			
			85°C	28°			

operating characteristics at specified free-air temperature, $V_{DD} = 10\text{ V}$

PARAMETER	TEST CONDITIONS		T_A	TLC27L4I TLC27L4AI TLC27L4BI TLC27L9I			UNIT
				MIN	TYP	MAX	
SR Slew rate at unity gain	$R_L = 1\text{ M}\Omega$, $C_L = 20\text{ pF}$, See Figure 1	$V_{I\text{PP}} = 1\text{ V}$	25°C	0.05			V/ μs
			-40°C	0.06			
			85°C	0.03			
		$V_{I\text{PP}} = 2.5\text{ V}$	25°C	0.04			
			-40°C	0.05			
			85°C	0.03			
V_n Equivalent input noise voltage	$f = 1\text{ Hz}$, See Figure 2	$R_S = 20\ \Omega$	25°C	70			nV/ $\sqrt{\text{Hz}}$
B_{OM} Maximum output-swing bandwidth	$V_O = V_{\text{OH}}$, $R_L = 1\text{ M}\Omega$,	$C_L = 20\text{ pF}$, See Figure 1	25°C	1			kHz
			-40°C	1.4			
			85°C	0.8			
B_1 Unity-gain bandwidth	$V_I = 10\text{ mV}$, See Figure 3	$C_L = 20\text{ pF}$,	25°C	110			kHz
			-40°C	155			
			85°C	80			
ϕ_m Phase margin	$V_I = 10\text{ mV}$, $C_L = 20\text{ pF}$,	$f = B_1$, See Figure 3	25°C	38°			
			-40°C	42°			
			85°C	32°			

8961724 0106673 677



TLC27L4, TLC27L4A, TLC27L4B, TLC27L4Y, TLC27L9 LinCMOS™ PRECISION QUAD OPERATIONAL AMPLIFIERS

SLOS053C - OCTOBER 1987 - REVISED AUGUST 1994

operating characteristics at specified free-air temperature, $V_{DD} = 5\text{ V}$

PARAMETER	TEST CONDITIONS		T_A	TLC27L4M TLC27L9M			UNIT
				MIN	TYP	MAX	
SR Slew rate at unity gain	$R_L = 1\text{ M}\Omega$, $C_L = 20\text{ pF}$, See Figure 1	$V_{Ipp} = 1\text{ V}$	25°C	0.03		V/ μ s	
			-55°C	0.04			
			125°C	0.02			
		$V_{Ipp} = 2.5\text{ V}$	25°C	0.03			
			-55°C	0.04			
			125°C	0.02			
V_n Equivalent input noise voltage	$f = 1\text{ kHz}$, See Figure 2	$R_S = 20\ \Omega$	25°C	70		nV/ $\sqrt{\text{Hz}}$	
B_{OM} Maximum output-swing bandwidth	$V_O = V_{OH}$, $R_L = 1\text{ M}\Omega$, See Figure 1	$C_L = 20\text{ pF}$, See Figure 1	25°C	5		kHz	
			-55°C	8			
			125°C	3			
B_1 Unity-gain bandwidth	$V_I = 10\text{ mV}$, See Figure 3	$C_L = 20\text{ pF}$	25°C	85		kHz	
			-55°C	140			
			125°C	45			
ϕ_m Phase margin	$V_I = 10\text{ mV}$, $C_L = 20\text{ pF}$,	$f = B_1$, See Figure 3	25°C	34°			
			-55°C	39°			
			125°C	25°			

operating characteristics at specified free-air temperature, $V_{DD} = 10\text{ V}$

PARAMETER	TEST CONDITIONS		T_A	TLC27L4M TLC27L9M			UNIT
				MIN	TYP	MAX	
SR Slew rate at unity gain	$R_L = 1\text{ M}\Omega$, $C_L = 20\text{ pF}$, See Figure 1	$V_{Ipp} = 1\text{ V}$	25°C	0.05		V/ μ s	
			-55°C	0.06			
			125°C	0.03			
		$V_{Ipp} = 5.5\text{ V}$	25°C	0.04			
			-55°C	0.06			
			125°C	0.03			
V_n Equivalent input noise voltage	$f = 1\text{ kHz}$, See Figure 2	$R_S = 20\ \Omega$	25°C	70		nV/ $\sqrt{\text{Hz}}$	
B_{OM} Maximum output-swing bandwidth	$V_O = V_{OH}$, $R_L = 1\text{ M}\Omega$, See Figure 1	$C_L = 20\text{ pF}$, See Figure 1	25°C	1		kHz	
			-55°C	1.5			
			125°C	0.7			
B_1 Unity-gain bandwidth	$V_I = 10\text{ mV}$, See Figure 3	$C_L = 20\text{ pF}$	25°C	110		kHz	
			-55°C	165			
			125°C	70			
ϕ_m Phase margin	$V_I = 10\text{ mV}$, $C_L = 20\text{ pF}$,	$f = B_1$, See Figure 3	25°C	38°			
			-55°C	43°			
			125°C	29°			

■ 8961724 0106674 503 ■



TLC27L4, TLC27L4A, TLC27L4B, TLC27L4Y, TLC27L9

LinCMOS™ PRECISION QUAD OPERATIONAL AMPLIFIERS

SLOS053C – OCTOBER 1987 – REVISED AUGUST 1994

operating characteristics, $V_{DD} = 5\text{ V}$, $T_A = 25^\circ\text{C}$

PARAMETER	TEST CONDITIONS		TLC27L4Y			UNIT
			MIN	TYP	MAX	
SR Slew rate at unity gain	$R_L = 1\text{ M}\Omega$, $C_L = 20\text{ pF}$, See Figure 1	$V_{Ipp} = 1\text{ V}$	0.03			$\text{V}/\mu\text{s}$
		$V_{Ipp} = 2.5\text{ V}$	0.03			
V_n Equivalent input noise voltage	$f = 1\text{ kHz}$, See Figure 2	$R_S = 20\ \Omega$,	70			$\text{nV}/\sqrt{\text{Hz}}$
BOM Maximum output-swing bandwidth	$V_O = V_{OH}$, $R_L = 1\text{ M}\Omega$,	$C_L = 20\text{ pF}$, See Figure 1	5			kHz
B_1 Unity-gain bandwidth	$V_I = 10\text{ mV}$, See Figure 3	$C_L = 20\text{ pF}$,	85			kHz
ϕ_m Phase margin	$V_I = 10\text{ mV}$, $C_L = 20\text{ pF}$,	$f = B_1$, See Figure 3	34°			

operating characteristics, $V_{DD} = 10\text{ V}$, $T_A = 25^\circ\text{C}$

PARAMETER	TEST CONDITIONS		TLC27L4Y			UNIT
			MIN	TYP	MAX	
SR Slew rate at unity gain	$R_L = 1\text{ M}\Omega$, $C_L = 20\text{ pF}$, See Figure 1	$V_{Ipp} = 1\text{ V}$	0.05			$\text{V}/\mu\text{s}$
		$V_{Ipp} = 5.5\text{ V}$	0.04			
V_n Equivalent input noise voltage	$f = 1\text{ kHz}$, See Figure 2	$R_S = 20\ \Omega$,	70			$\text{nV}/\sqrt{\text{Hz}}$
BOM Maximum output-swing bandwidth	$V_O = V_{OH}$, $R_L = 1\text{ M}\Omega$,	$C_L = 20\text{ pF}$, See Figure 1	1			kHz
B_1 Unity-gain bandwidth	$V_I = 10\text{ mV}$, See Figure 3	$C_L = 20\text{ pF}$,	110			kHz
ϕ_m Phase margin	$V_I = 10\text{ mV}$, $C_L = 20\text{ pF}$,	$f = B_1$, See Figure 3	38°			

8961724 0106675 44T



TLC27L4, TLC27L4A, TLC27L4B, TLC27L4Y, TLC27L9 LinCMOS™ PRECISION QUAD OPERATIONAL AMPLIFIERS

SLOS053C – OCTOBER 1987 – REVISED AUGUST 1994

PARAMETER MEASUREMENT INFORMATION

single-supply versus split-supply test circuits

Because the TLC27L4 and TLC27L9 are optimized for single-supply operation, circuit configurations used for the various tests often present some inconvenience since the input signal, in many cases, must be offset from ground. This inconvenience can be avoided by testing the device with split supplies and the output load tied to the negative rail. A comparison of single-supply versus split-supply test circuits is shown below. The use of either circuit gives the same result.

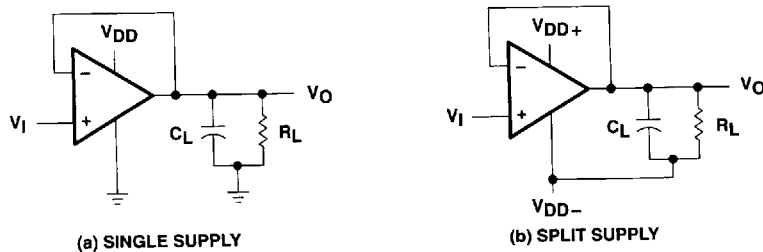

Figure 1. Unity-Gain Amplifier

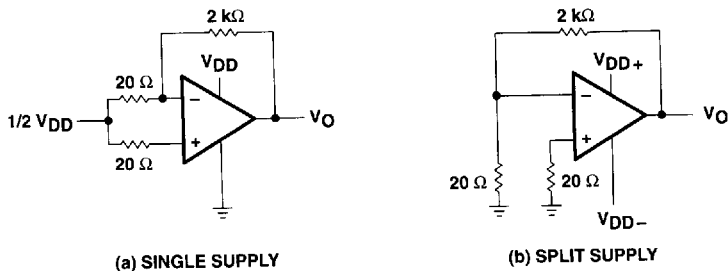

Figure 2. Noise-Test Circuit

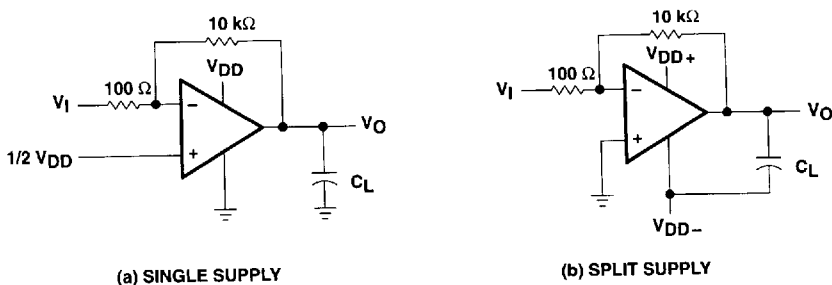

Figure 3. Gain-of-100 Inverting Amplifier

8961724 0106676 386

 **TEXAS
INSTRUMENTS**

POST OFFICE BOX 655303 • DALLAS, TEXAS 75265

3-685

TLC27L4, TLC27L4A, TLC27L4B, TLC27L4Y, TLC27L9 LinCMOS™ PRECISION QUAD OPERATIONAL AMPLIFIERS

SLOS053C – OCTOBER 1987 – REVISED AUGUST 1994

PARAMETER MEASUREMENT INFORMATION

input bias current

Because of the high input impedance of the TLC27L4 and TLC27L9 operational amplifiers, attempts to measure the input bias current can result in erroneous readings. The bias current at normal room ambient temperature is typically less than 1 pA, a value that is easily exceeded by leakages on the test socket. Two suggestions are offered to avoid erroneous measurements:

1. Isolate the device from other potential leakage sources. Use a grounded shield around and between the device inputs (see Figure 4). Leakages that would otherwise flow to the inputs are shunted away.
2. Compensate for the leakage of the test socket by actually performing an input bias current test (using a picoammeter) with no device in the test socket. The actual input bias current can then be calculated by subtracting the open-socket leakage readings from the readings obtained with a device in the test socket.

One word of caution: many automatic testers as well as some bench-top operational amplifier testers use the servo-loop technique with a resistor in series with the device input to measure the input bias current (the voltage drop across the series resistor is measured and the bias current is calculated). This method requires that a device be inserted into the test socket to obtain a correct reading; therefore, an open-socket reading is not feasible using this method.

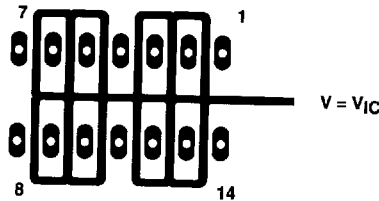

Figure 4. Isolation Metal Around Device Inputs (J and N packages)

low-level output voltage

To obtain low-supply-voltage operation, some compromise was necessary in the input stage. This compromise results in the device low-level output being dependent on both the common-mode input voltage level as well as the differential input voltage level. When attempting to correlate low-level output readings with those quoted in the electrical specifications, these two conditions should be observed. If conditions other than these are to be used, please refer to Figures 14 through 19 in the Typical Characteristics of this data sheet.

input offset voltage temperature coefficient

Erroneous readings often result from attempts to measure temperature coefficient of input offset voltage. This parameter is actually a calculation using input offset voltage measurements obtained at two different temperatures. When one (or both) of the temperatures is below freezing, moisture can collect on both the device and the test socket. This moisture results in leakage and contact resistance, which can cause erroneous input offset voltage readings. The isolation techniques previously mentioned have no effect on the leakage since the moisture also covers the isolation metal itself, thereby rendering it useless. It is suggested that these measurements be performed at temperatures above freezing to minimize error.

8961724 0106677 212

 **TEXAS
INSTRUMENTS**

POST OFFICE BOX 655303 • DALLAS, TEXAS 75265

TLC27L4, TLC27L4A, TLC27L4B, TLC27L4Y, TLC27L9 LinCMOS™ PRECISION QUAD OPERATIONAL AMPLIFIERS

SLOS053C – OCTOBER 1987 – REVISED AUGUST 1994

PARAMETER MEASUREMENT INFORMATION

full-power response

Full-power response, the frequency above which the operational amplifier slew rate limits the output voltage swing, is often specified two ways: full-linear response and full-peak response. The full-linear response is generally measured by monitoring the distortion level of the output while increasing the frequency of a sinusoidal input signal until the maximum frequency is found above which the output contains significant distortion. The full-peak response is defined as the maximum output frequency, without regard to distortion, above which full peak-to-peak output swing cannot be maintained.

Because there is no industry-wide accepted value for significant distortion, the full-peak response is specified in this data sheet and is measured using the circuit of Figure 1. The initial setup involves the use of a sinusoidal input to determine the maximum peak-to-peak output of the device (the amplitude of the sinusoidal wave is increased until clipping occurs). The sinusoidal wave is then replaced with a square wave of the same amplitude. The frequency is then increased until the maximum peak-to-peak output can no longer be maintained (Figure 5). A square wave is used to allow a more accurate determination of the point at which the maximum peak-to-peak output is reached.

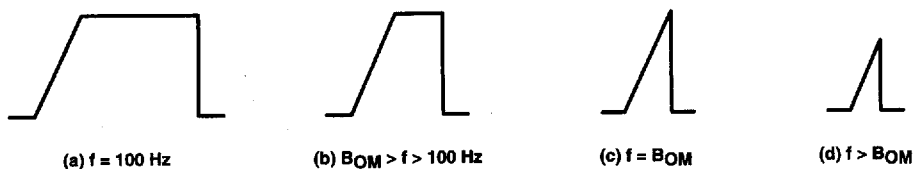

Figure 5. Full-Power-Response Output Signal

test time

Inadequate test time is a frequent problem, especially when testing CMOS devices in a high-volume, short-test-time environment. Internal capacitances are inherently higher in CMOS than in bipolar and BiFET devices and require longer test times than their bipolar and BiFET counterparts. The problem becomes more pronounced with reduced supply levels and lower temperatures.

8961724 0106678 159

 **TEXAS
INSTRUMENTS**

POST OFFICE BOX 655303 • DALLAS, TEXAS 75265

3-687

TLC27L4, TLC27L4A, TLC27L4B, TLC27L4Y, TLC27L9 LinCMOS™ PRECISION QUAD OPERATIONAL AMPLIFIERS

SLOS053C – OCTOBER 1987 – REVISED AUGUST 1994

TYPICAL CHARACTERISTICS

Table of Graphs

			FIGURE
V_{IO}	Input offset voltage	Distribution	6, 7
α_{VIO}	Temperature coefficient	Distribution	8, 9
V_{OH}	High-level output voltage	vs High-level output current	10, 11
		vs Supply voltage	12
		vs Free-air temperature	13
V_{OL}	Low-level output voltage	vs Common-mode input voltage	14, 15
		vs Differential input voltage	16
		vs Free-air temperature	17
		vs Low-level output current	18, 19
A_{VD}	Differential voltage amplification	vs Supply voltage	20
		vs Free-air temperature	21
		vs Frequency	32, 33
I_{IB}/I_{IO}	Input bias and input offset current	vs Free-air temperature	22
V_{IC}	Common-mode input voltage	vs Supply voltage	23
I_{DD}	Supply current	vs Supply voltage	24
		vs Free-air temperature	25
SR	Slew rate	vs Supply voltage	26
		vs Free-air temperature	27
	Normalized slew rate	vs Free-air temperature	28
$V_{O(PP)}$	Maximum peak-to-peak output voltage	vs Frequency	29
B_1	Unity-gain bandwidth	vs Free-air temperature	30
		vs Supply voltage	31
ϕ_m	Phase margin	vs Supply voltage	34
		vs Free-air temperature	35
		vs Capacitive loads	36
V_n	Equivalent input noise voltage	vs Frequency	37
ϕ	Phase shift	vs Frequency	32, 33

8961724 0106679 095

 **TEXAS
INSTRUMENTS**

POST OFFICE BOX 655303 • DALLAS, TEXAS 75265

TLC27L4, TLC27L4A, TLC27L4B, TLC27L4Y, TLC27L9 LinCMOS™ PRECISION QUAD OPERATIONAL AMPLIFIERS

SLOS053C – OCTOBER 1987 – REVISED AUGUST 1994

TYPICAL CHARACTERISTICS

**DISTRIBUTION OF TLC27L4
INPUT OFFSET VOLTAGE**

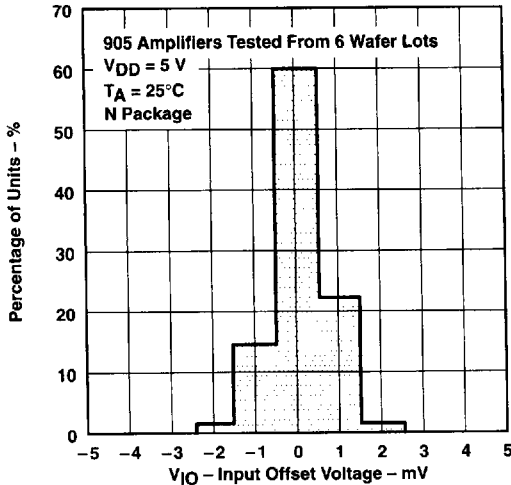

Figure 6

**DISTRIBUTION OF TLC27L4
INPUT OFFSET VOLTAGE**

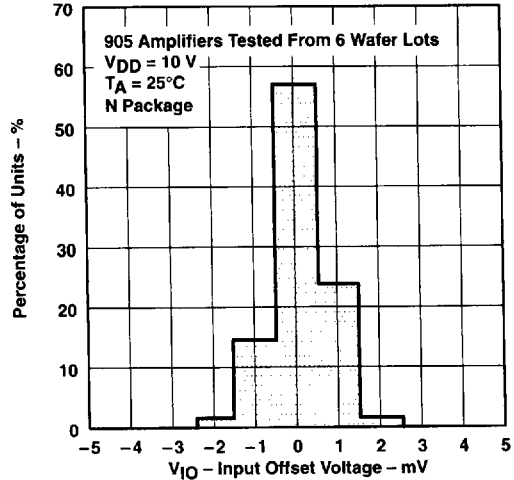

Figure 7

**DISTRIBUTION OF TLC27L4 AND TLC27L9
INPUT OFFSET VOLTAGE
TEMPERATURE COEFFICIENT**

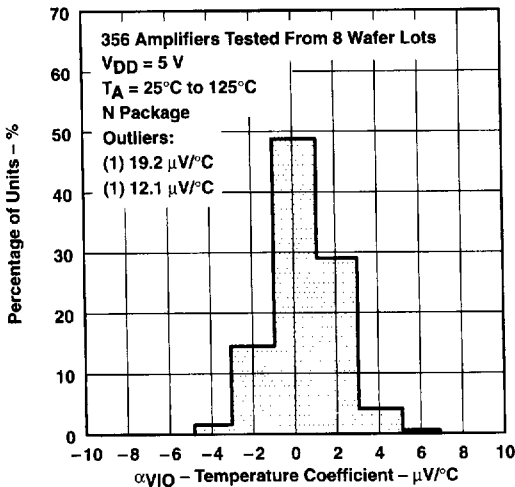

Figure 8

**DISTRIBUTION OF TLC27L4 AND TLC27L9
INPUT OFFSET VOLTAGE
TEMPERATURE COEFFICIENT**

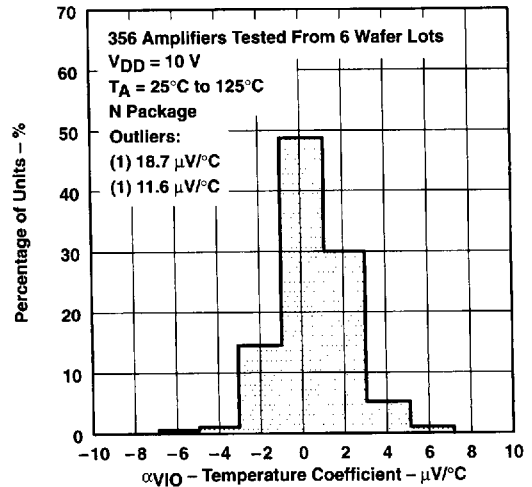

Figure 9

8961724 0106680 807

**TEXAS
INSTRUMENTS**

POST OFFICE BOX 655303 • DALLAS, TEXAS 75265

3-689

TLC27L4, TLC27L4A, TLC27L4B, TLC27L4Y, TLC27L9 LinCMOS™ PRECISION QUAD OPERATIONAL AMPLIFIERS

SLOS053C – OCTOBER 1987 – REVISED AUGUST 1994

TYPICAL CHARACTERISTICS†

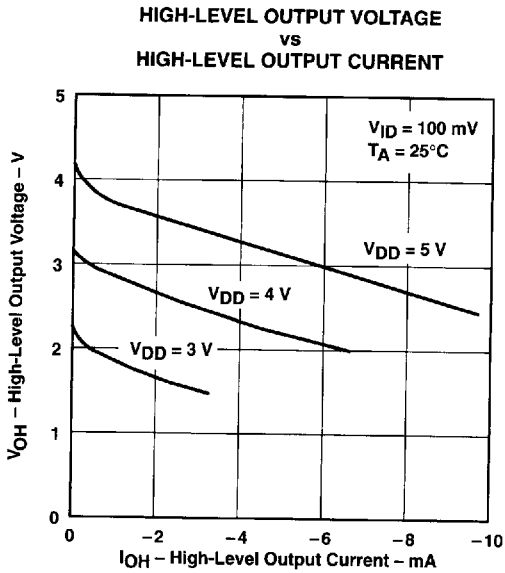

Figure 10

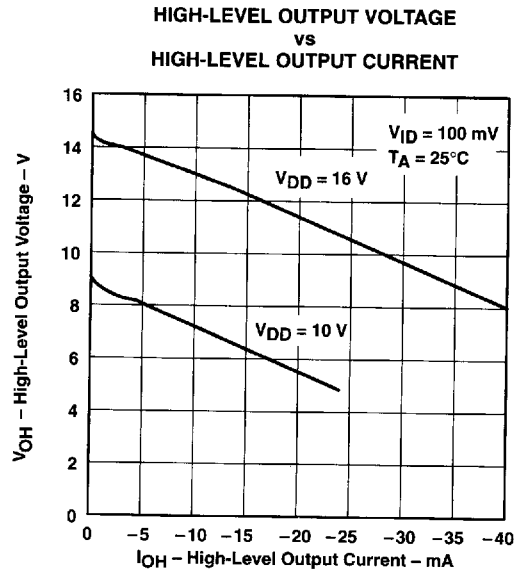

Figure 11

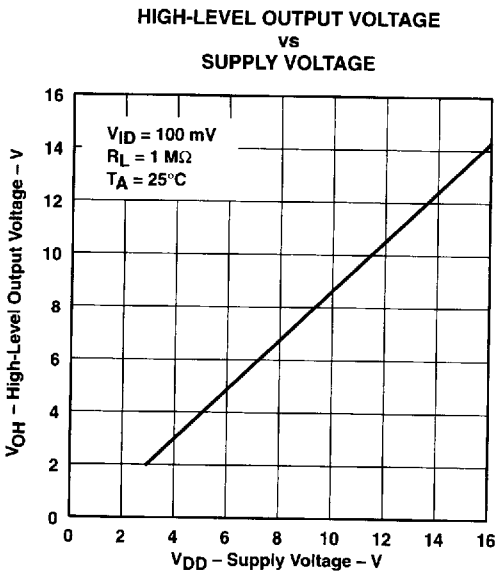

Figure 12

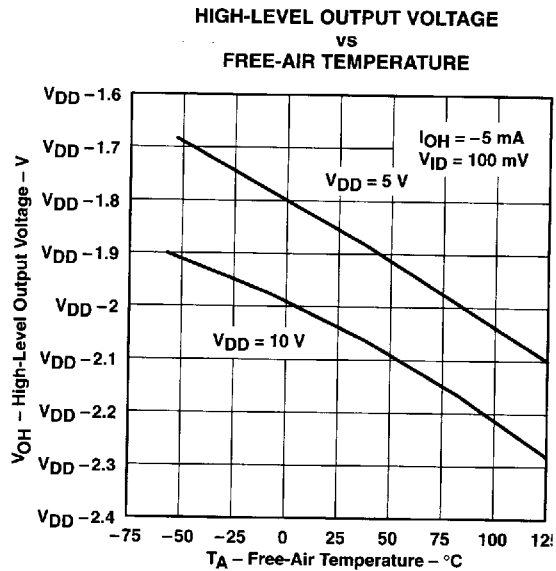

Figure 13

† Data at high and low temperatures are applicable only within the rated operating free-air temperature ranges of the various devices.



8961724 0106681 743

TLC27L4, TLC27L4A, TLC27L4B, TLC27L4Y, TLC27L9 LinCMOS™ PRECISION QUAD OPERATIONAL AMPLIFIERS

SLOS053C - OCTOBER 1987 - REVISED AUGUST 1994

TYPICAL CHARACTERISTICS†

LOW-LEVEL OUTPUT VOLTAGE
vs
COMMON-MODE INPUT VOLTAGE

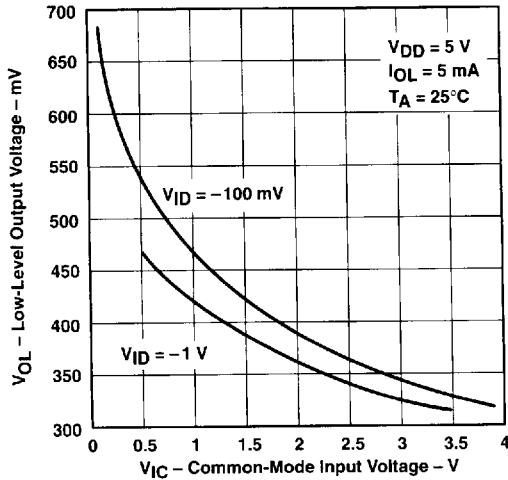

Figure 14

LOW-LEVEL OUTPUT VOLTAGE
vs
COMMON-MODE INPUT VOLTAGE

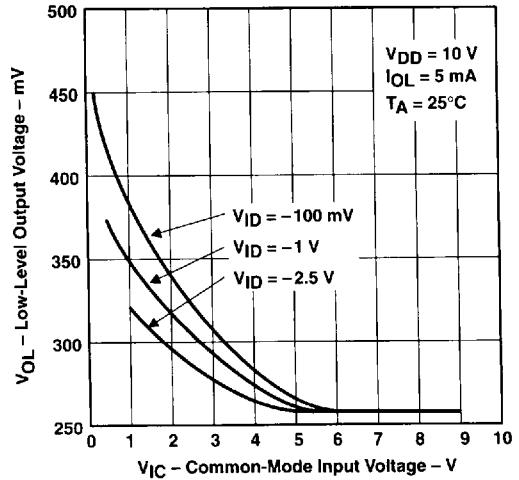

Figure 15

LOW-LEVEL OUTPUT VOLTAGE
vs
DIFFERENTIAL INPUT VOLTAGE

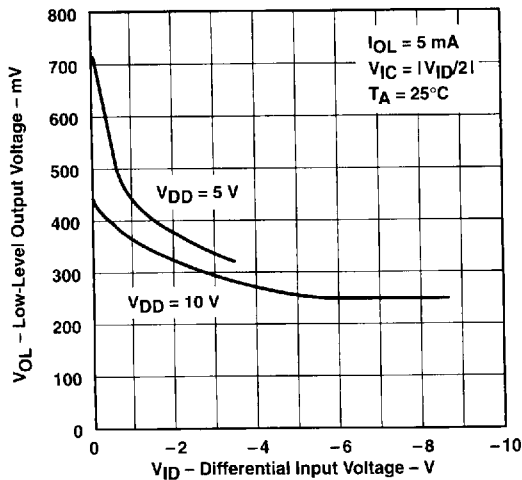

Figure 16

LOW-LEVEL OUTPUT VOLTAGE
vs
FREE-AIR TEMPERATURE

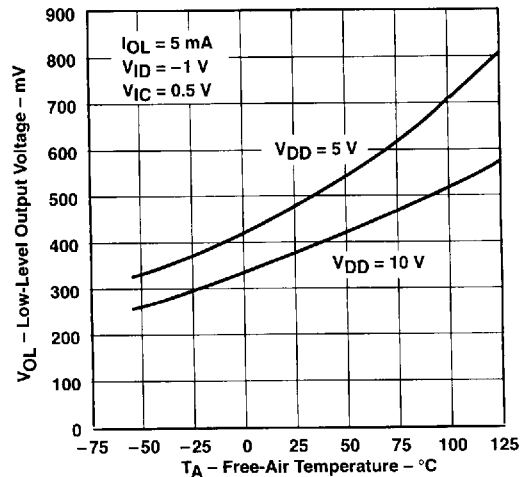

Figure 17

† Data at high and low temperatures are applicable only within the rated operating free-air temperature ranges of the various devices.

TLC27L4, TLC27L4A, TLC27L4B, TLC27L4Y, TLC27L9 LinCMOS™ PRECISION QUAD OPERATIONAL AMPLIFIERS

SLOS053C – OCTOBER 1987 – REVISED AUGUST 1994

TYPICAL CHARACTERISTICS†

LOW-LEVEL OUTPUT VOLTAGE
vs
LOW-LEVEL OUTPUT CURRENT

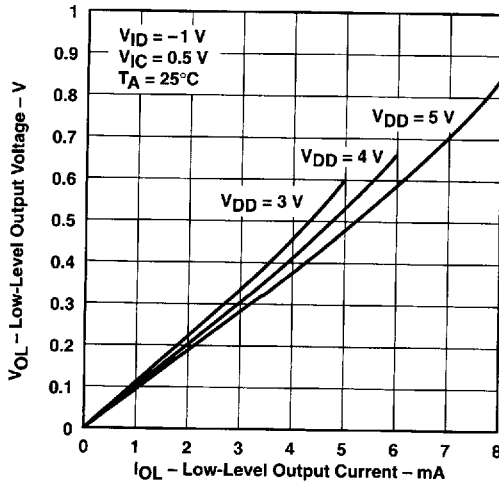

Figure 18

LOW-LEVEL OUTPUT VOLTAGE
vs
LOW-LEVEL OUTPUT CURRENT

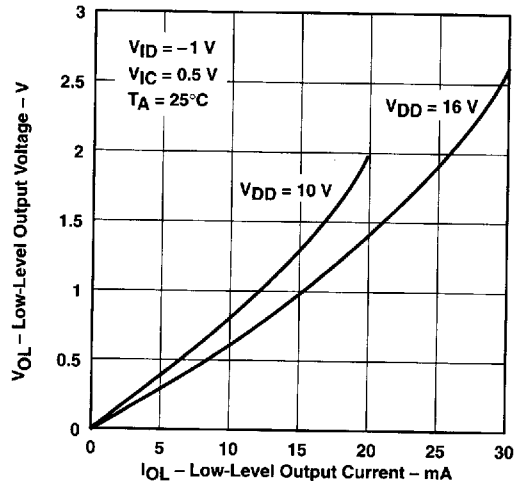

Figure 19

LARGE-SIGNAL
DIFFERENTIAL VOLTAGE AMPLIFICATION
vs
SUPPLY VOLTAGE

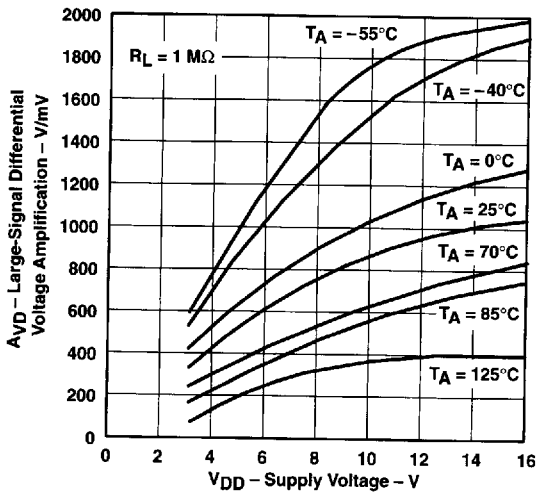

Figure 20

LARGE-SIGNAL
DIFFERENTIAL VOLTAGE AMPLIFICATION
vs
FREE-AIR TEMPERATURE

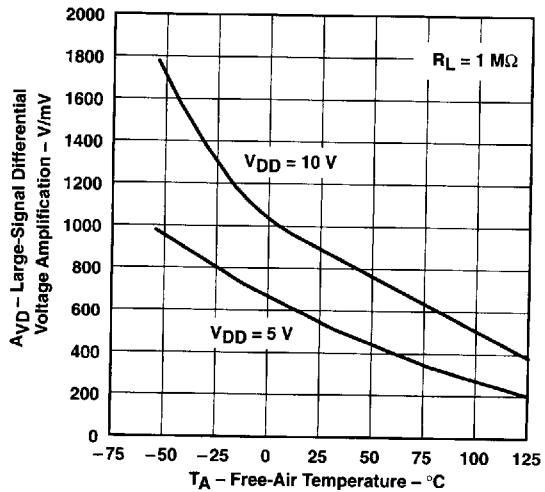

Figure 21

† Data at high and low temperatures are applicable only within the rated operating free-air temperature ranges of the various devices.

8961724 0106683 516



POST OFFICE BOX 655303 • DALLAS, TEXAS 75265

TLC27L4, TLC27L4A, TLC27L4B, TLC27L4Y, TLC27L9 LinCMOS™ PRECISION QUAD OPERATIONAL AMPLIFIERS

SLOS053C – OCTOBER 1987 – REVISED AUGUST 1994

TYPICAL CHARACTERISTICS†

**INPUT BIAS CURRENT AND INPUT OFFSET CURRENT
vs
FREE-AIR TEMPERATURE**

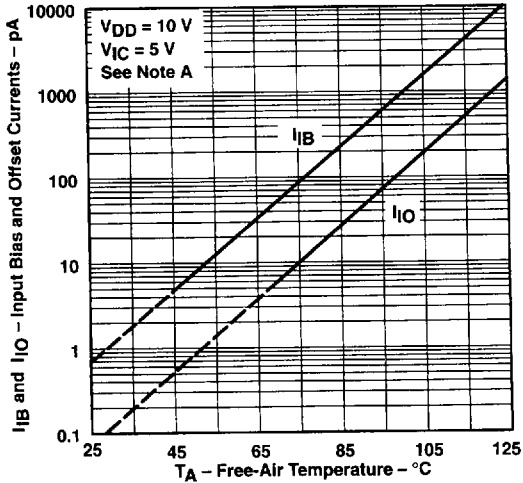

NOTE A: The typical values of input bias current and input offset current below 5 pA were determined mathematically.

Figure 22

**COMMON-MODE
INPUT VOLTAGE POSITIVE LIMIT
vs
SUPPLY VOLTAGE**

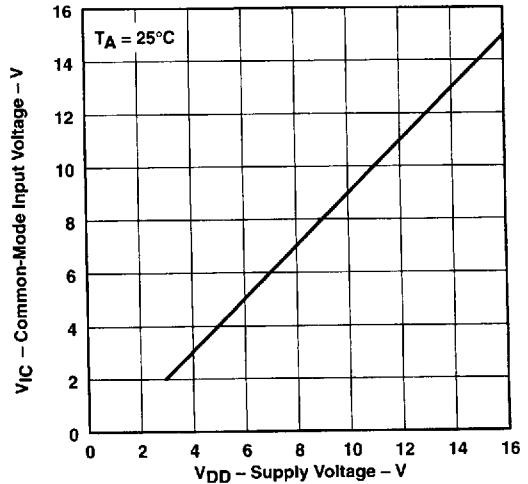

Figure 23

**SUPPLY CURRENT
vs
SUPPLY VOLTAGE**

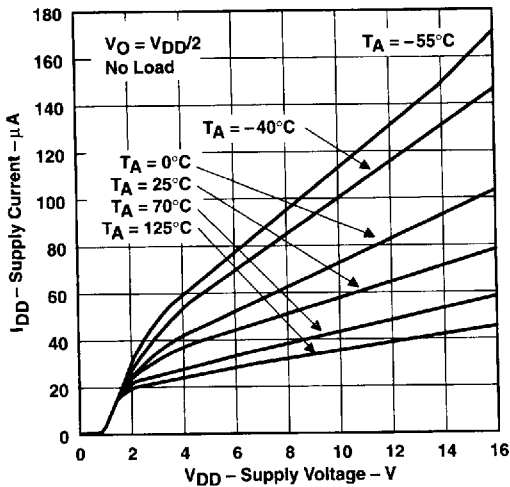

Figure 24

**SUPPLY CURRENT
vs
FREE-AIR TEMPERATURE**

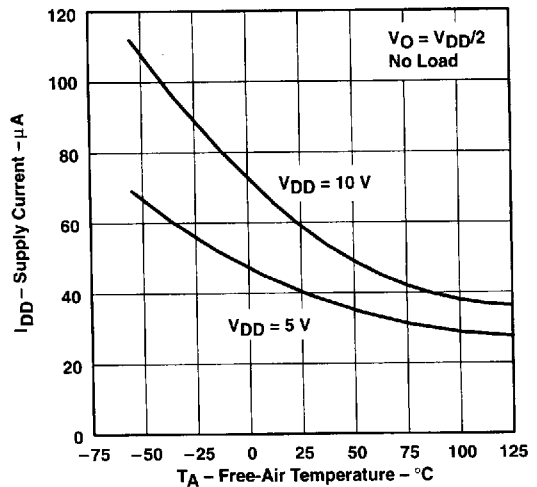

Figure 25

† Data at high and low temperatures are applicable only within the rated operating free-air temperature ranges of the various devices.

TLC27L4, TLC27L4A, TLC27L4B, TLC27L4Y, TLC27L9 LinCMOS™ PRECISION QUAD OPERATIONAL AMPLIFIERS

SLOS053C – OCTOBER 1987 – REVISED AUGUST 1994

TYPICAL CHARACTERISTICS†

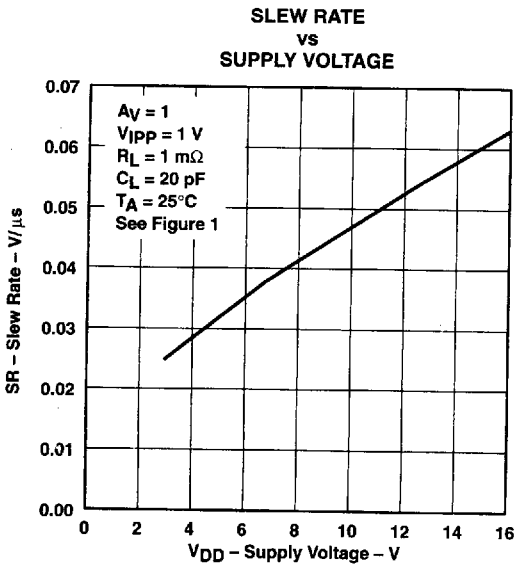

Figure 26

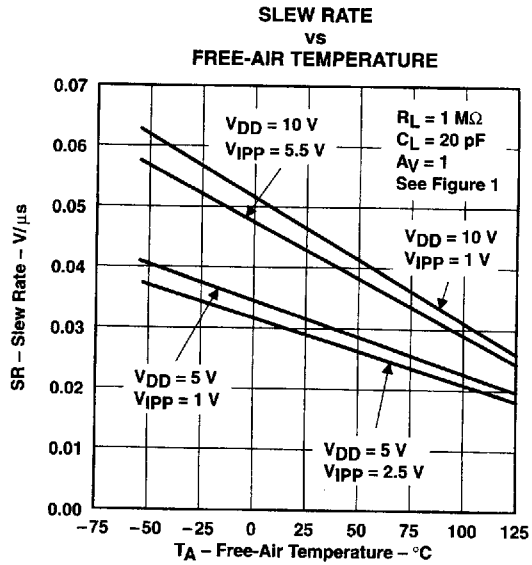

Figure 27

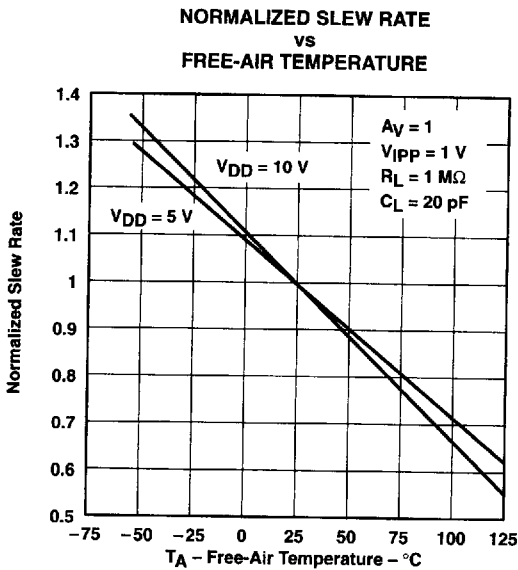

Figure 28

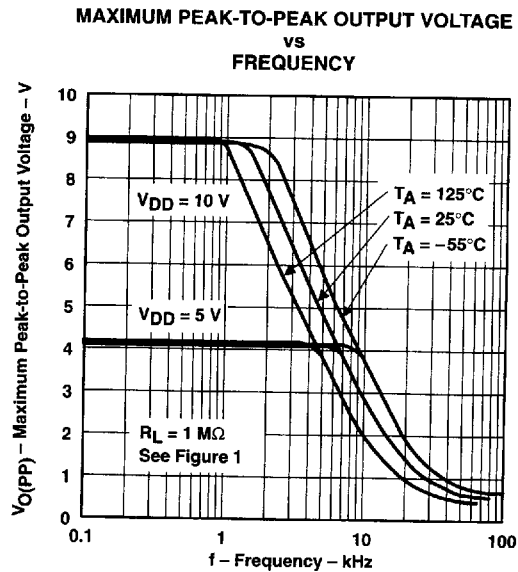

Figure 29

† Data at high and low temperatures are applicable only within the rated operating free-air temperature ranges of the various devices.

8961724 0106685 399

**TEXAS
INSTRUMENTS**

TLC27L4, TLC27L4A, TLC27L4B, TLC27L4Y, TLC27L9 LinCMOS™ PRECISION QUAD OPERATIONAL AMPLIFIERS

SLOS053C – OCTOBER 1987 – REVISED AUGUST 1994

TYPICAL CHARACTERISTICS†

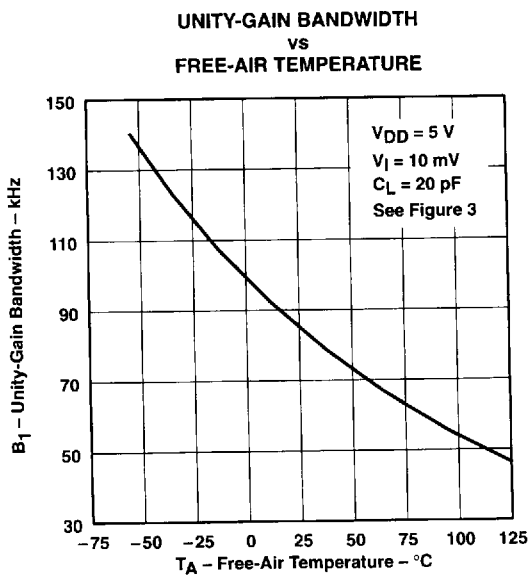

Figure 30

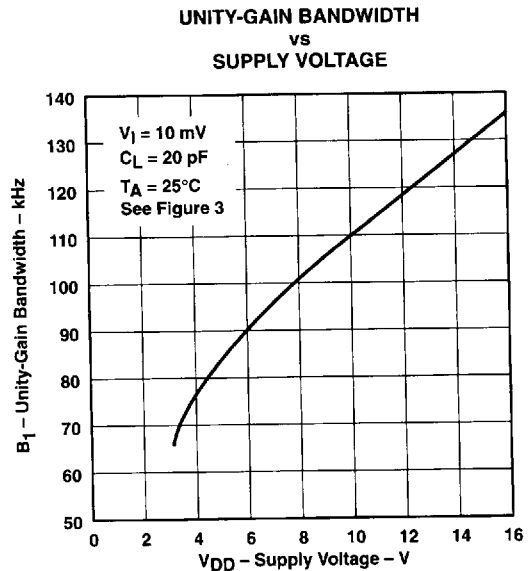

Figure 31

**LARGE-SIGNAL DIFFERENTIAL VOLTAGE
AMPLIFICATION AND PHASE SHIFT
vs
FREQUENCY**

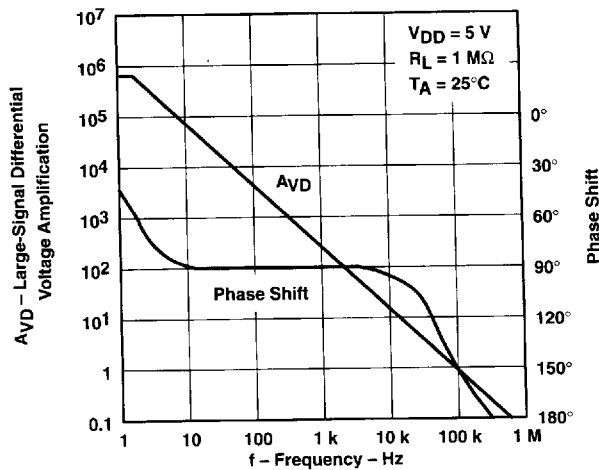

Figure 32

† Data at high and low temperatures are applicable only within the rated operating free-air temperature ranges of the various devices.



POST OFFICE BOX 655303 • DALLAS, TEXAS 75265

8961724 0106686 225

TLC27L4, TLC27L4A, TLC27L4B, TLC27L4Y, TLC27L9 LinCMOS™ PRECISION QUAD OPERATIONAL AMPLIFIERS

SLOS053C – OCTOBER 1987 – REVISED AUGUST 1994

TYPICAL CHARACTERISTICS†

LARGE-SIGNAL DIFFERENTIAL VOLTAGE AMPLIFICATION AND PHASE SHIFT vs FREQUENCY

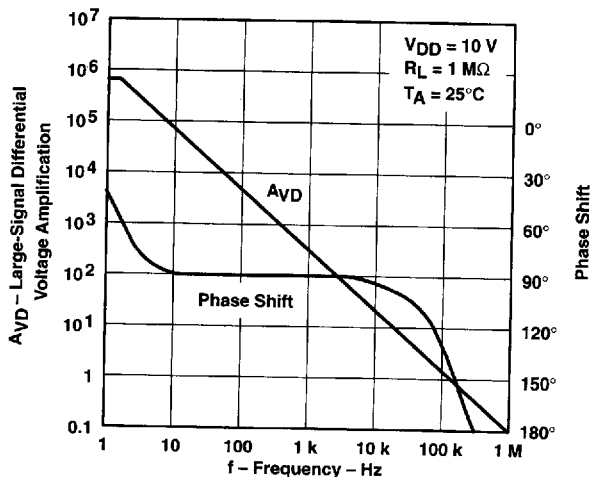

Figure 33

PHASE MARGIN vs SUPPLY VOLTAGE

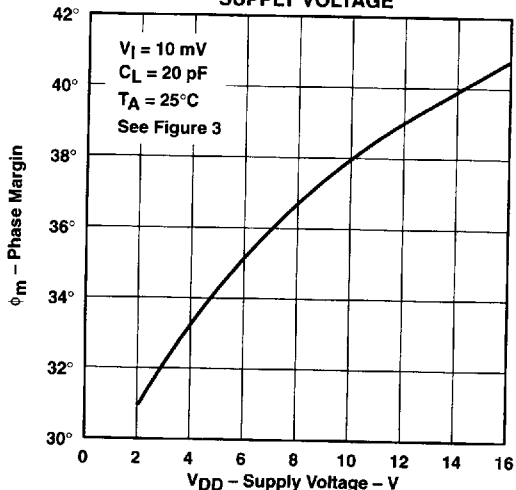

Figure 34

PHASE MARGIN vs FREE-AIR TEMPERATURE

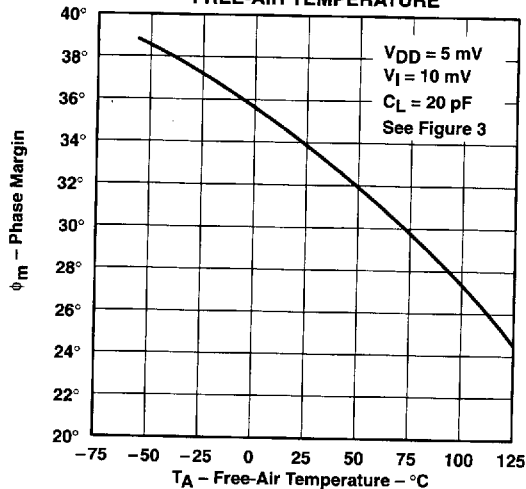

Figure 35

† Data at high and low temperatures are applicable only within the rated operating free-air temperature ranges of the various devices.



TEXAS
INSTRUMENTS

POST OFFICE BOX 655303 • DALLAS, TEXAS 75265

TLC27L4, TLC27L4A, TLC27L4B, TLC27L4Y, TLC27L9 LinCMOS™ PRECISION QUAD OPERATIONAL AMPLIFIERS

SLOS053C – OCTOBER 1987 – REVISED AUGUST 1994

TYPICAL CHARACTERISTICS

**PHASE MARGIN
VS
CAPACITIVE LOAD**

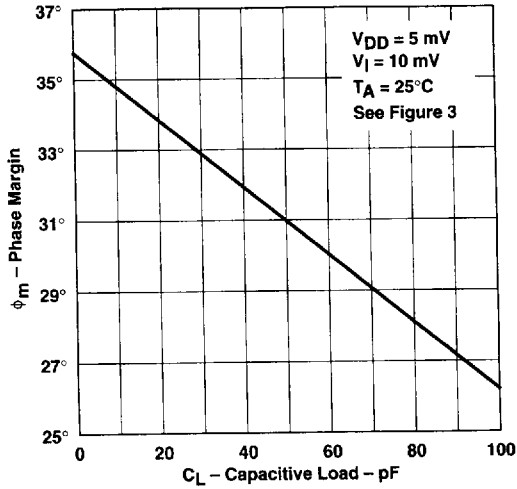

Figure 36

**EQUIVALENT INPUT NOISE VOLTAGE
VS
FREQUENCY**

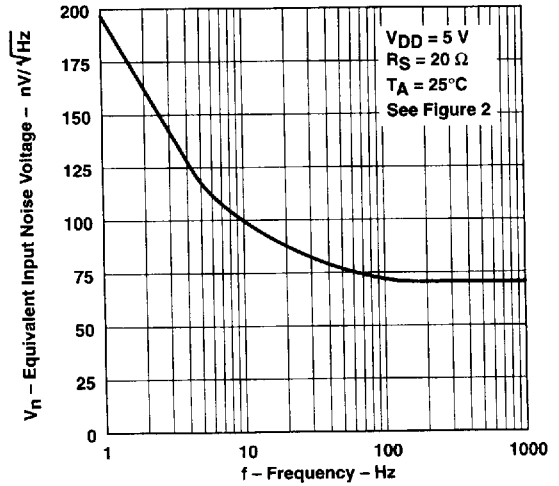

Figure 37

8961724 0106688 0T8

**TEXAS
INSTRUMENTS**

POST OFFICE BOX 655303 • DALLAS, TEXAS 75265

TLC27L4, TLC27L4A, TLC27L4B, TLC27L4Y, TLC27L9 LinCMOS™ PRECISION QUAD OPERATIONAL AMPLIFIERS

SLOS053C – OCTOBER 1987 – REVISED AUGUST 1994

APPLICATION INFORMATION

single-supply operation

While the TLC27L4 and TLC27L9 perform well using dual power supplies (also called balanced or split supplies), the design is optimized for single-supply operation. This design includes an input common-mode voltage range that encompasses ground as well as an output voltage range that pulls down to ground. The supply voltage range extends down to 3 V (C-suffix types), thus allowing operation with supply levels commonly available for TTL and HCMOS; however, for maximum dynamic range, 16-V single-supply operation is recommended.

Many single-supply applications require that a voltage be applied to one input to establish a reference level that is above ground. A resistive voltage divider is usually sufficient to establish this reference level (see Figure 38). The low input bias current of the TLC27L4 and TLC27L9 permits the use of very large resistive values to implement the voltage divider, thus minimizing power consumption.

The TLC27L4 and TLC27L9 work well in conjunction with digital logic; however, when powering both linear devices and digital logic from the same power supply, the following precautions are recommended:

1. Power the linear devices from separate bypassed supply lines (see Figure 39); otherwise, the linear device supply rails can fluctuate due to voltage drops caused by high switching currents in the digital logic.
2. Use proper bypass techniques to reduce the probability of noise-induced errors. Single capacitive decoupling is often adequate; however, high-frequency applications may require RC decoupling.

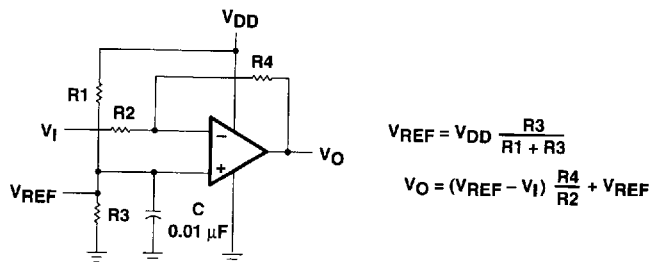

Figure 38. Inverting Amplifier With Voltage Reference

8961724 0106689 T34

 **TEXAS
INSTRUMENTS**

POST OFFICE BOX 655303 • DALLAS, TEXAS 75265

APPLICATION INFORMATION

single-supply operation (continued)

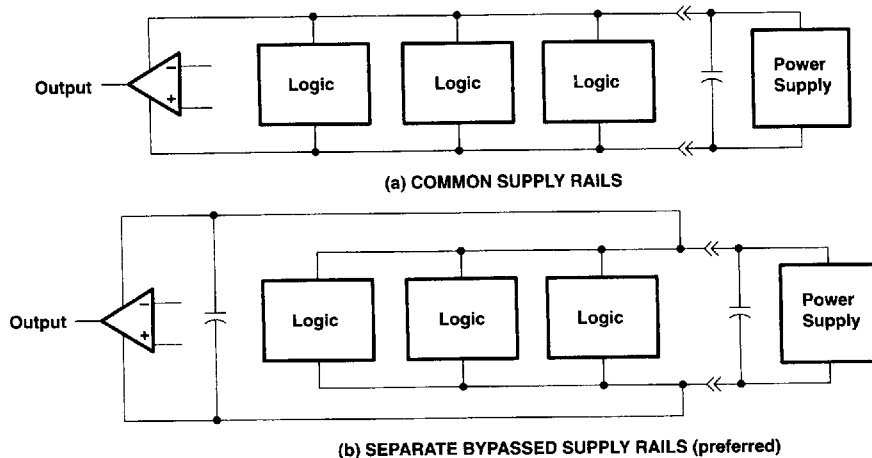

Figure 39. Common Versus Separate Supply Rails

input characteristics

The TLC27L4 and TLC27L9 are specified with a minimum and a maximum input voltage that, if exceeded at either input, could cause the device to malfunction. Exceeding this specified range is a common problem, especially in single-supply operation. Note that the lower range limit includes the negative rail, while the upper range limit is specified at $V_{DD} - 1\text{ V}$ at $T_A = 25^\circ\text{C}$ and at $V_{DD} - 1.5\text{ V}$ at all other temperatures.

The use of the polysilicon-gate process and the careful input circuit design gives the TLC27L4 and TLC27L9 very good input offset voltage drift characteristics relative to conventional metal-gate processes. Offset voltage drift in CMOS devices is highly influenced by threshold voltage shifts caused by polarization of the phosphorus dopant implanted in the oxide. Placing the phosphorus dopant in a conductor (such as a polysilicon gate) alleviates the polarization problem, thus reducing threshold voltage shifts by more than an order of magnitude. The offset voltage drift with time has been calculated to be typically $0.1\ \mu\text{V}/\text{month}$, including the first month of operation.

Because of the extremely high input impedance and resulting low bias current requirements, the TLC27L4 and TLC27L9 are well suited for low-level signal processing; however, leakage currents on printed circuit boards and sockets can easily exceed bias current requirements and cause a degradation in device performance. It is good practice to include guard rings around inputs (similar to those of Figure 4 in the Parameter Measurement Information section). These guards should be driven from a low-impedance source at the same voltage level as the common-mode input (see Figure 40).

The inputs of any unused amplifiers should be tied to ground to avoid possible oscillation.

noise performance

The noise specifications in operational amplifier circuits are greatly dependent on the current in the first-stage differential amplifier. The low input bias current requirements of the TLC27L4 and TLC27L9 result in a very low noise current, which is insignificant in most applications. This feature makes the devices especially favorable over bipolar devices when using values of circuit impedance greater than $50\ \text{k}\Omega$, since bipolar devices exhibit greater noise currents.

8961724 0106690 756

TLC27L4, TLC27L4A, TLC27L4B, TLC27L4Y, TLC27L9 LinCMOS™ PRECISION QUAD OPERATIONAL AMPLIFIERS

SLOS053C – OCTOBER 1987 – REVISED AUGUST 1994

APPLICATION INFORMATION

noise performance (continued)

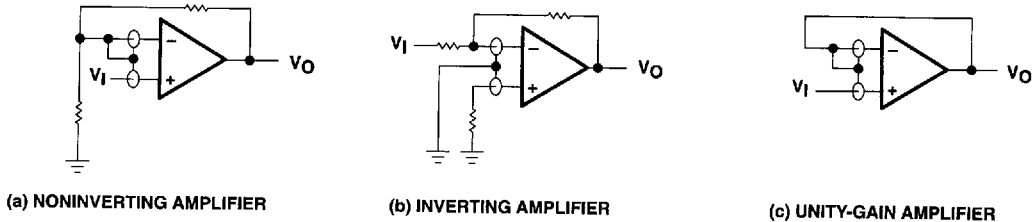

Figure 40. Guard-Ring Schemes

output characteristics

The output stage of the TLC27L4 and TLC27L9 is designed to sink and source relatively high amounts of current (see typical characteristics). If the output is subjected to a short-circuit condition, this high current capability can cause device damage under certain conditions. Output current capability increases with supply voltage.

All operating characteristics of the TLC27L4 and TLC27L9 were measured using a 20-pF load. The devices drive higher capacitive loads; however, as output load capacitance increases, the resulting response pole occurs at lower frequencies, thereby causing ringing, peaking, or even oscillation (see Figure 41). In many cases, adding a small amount of resistance in series with the load capacitance alleviates the problem.

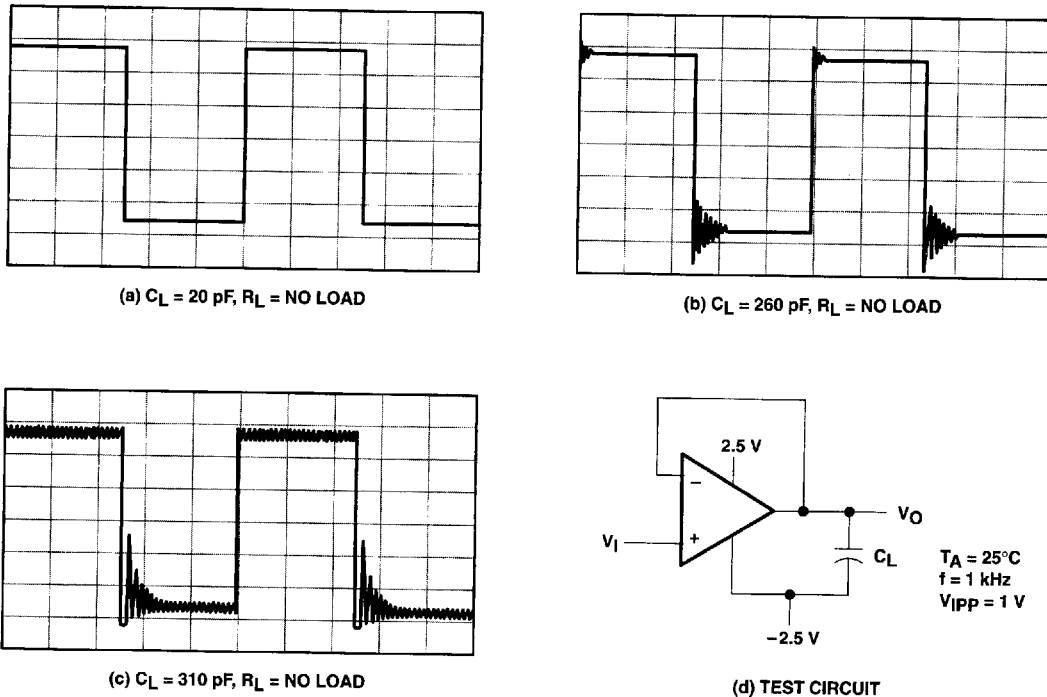

Figure 41. Effect of Capacitive Loads and Test Circuit

8961724 0106691 692
**TEXAS
INSTRUMENTS**

POST OFFICE BOX 655303 • DALLAS, TEXAS 75265

APPLICATION INFORMATION

output characteristics (continued)

Although the TLC27L4 and TLC27L9 possess excellent high-level output voltage and current capability, methods for boosting this capability are available, if needed. The simplest method involves the use of a pullup resistor (R_p) connected from the output to the positive supply rail (see Figure 42). There are two disadvantages to the use of this circuit. First, the NMOS pulldown transistor N4 (see equivalent schematic) must sink a comparatively large amount of current. In this circuit, N4 behaves like a linear resistor with an on-resistance between approximately 60 Ω and 180 Ω , depending on how hard the operational amplifier input is driven. With very low values of R_p , a voltage offset from 0 V at the output occurs. Second, pullup resistor R_p acts as a drain load to N4 and the gain of the operational amplifier is reduced at output voltage levels where N5 is not supplying the output current.

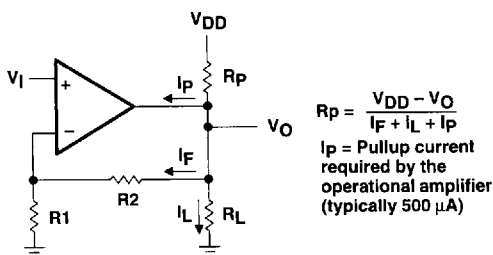

Figure 42. Resistive Pullup to Increase V_{OH}

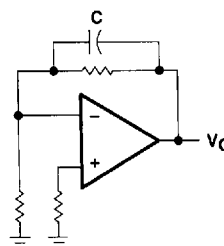

Figure 43. Compensation for Input Capacitance

feedback

Operational amplifier circuits nearly always employ feedback, and since feedback is the first prerequisite for oscillation, some caution is appropriate. Most oscillation problems result from driving capacitive loads (discussed previously) and ignoring stray input capacitance. A small-value capacitor connected in parallel with the feedback resistor is an effective remedy (see Figure 43). The value of this capacitor is optimized empirically.

electrostatic discharge protection

The TLC27L4 and TLC27L9 incorporate an internal electrostatic discharge (ESD) protection circuit that prevents functional failures at voltages up to 2000 V as tested under MIL-STD-883C, Method 3015.2. Care should be exercised, however, when handling these devices, as exposure to ESD may result in the degradation of the device parametric performance. The protection circuit also causes the input bias currents to be temperature dependent and have the characteristics of a reverse-biased diode.

latch-up

Because CMOS devices are susceptible to latch-up due to their inherent parasitic thyristors, the TLC27L4 and TLC27L9 inputs and outputs were designed to withstand –100-mA surge currents without sustaining latch-up; however, techniques should be used to reduce the chance of latch-up whenever possible. Internal protection diodes should not, by design, be forward biased. Applied input and output voltage should not exceed the supply voltage by more than 300 mV. Care should be exercised when using capacitive coupling on pulse generators. Supply transients should be shunted by the use of decoupling capacitors (0.1 μF typical) located across the supply rails as close to the device as possible.

8961724 0106692 529

TLC27L4, TLC27L4A, TLC27L4B, TLC27L4Y, TLC27L9 LinCMOS™ PRECISION QUAD OPERATIONAL AMPLIFIERS

SLOS053C – OCTOBER 1987 – REVISED AUGUST 1994

APPLICATION INFORMATION

latch-up (continued)

The current path established if latch-up occurs is usually between the positive supply rail and ground and can be triggered by surges on the supply lines and/or voltages on either the output or inputs that exceed the supply voltage. Once latch-up occurs, the current flow is limited only by the impedance of the power supply and the forward resistance of the parasitic thyristor and usually results in the destruction of the device. The chance of latch-up occurring increases with increasing temperature and supply voltages.

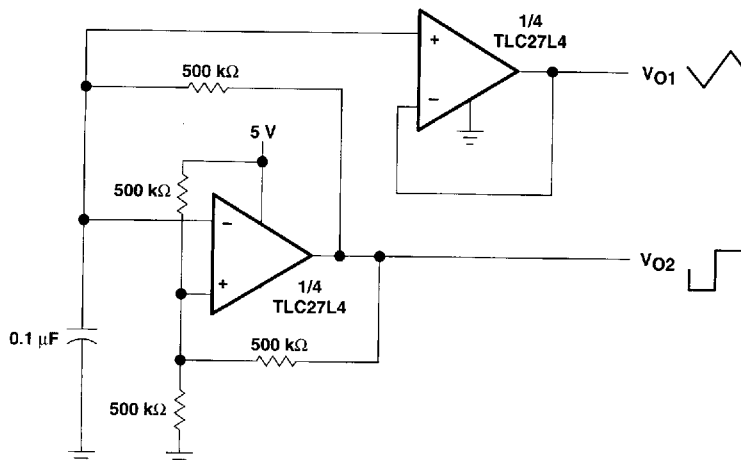
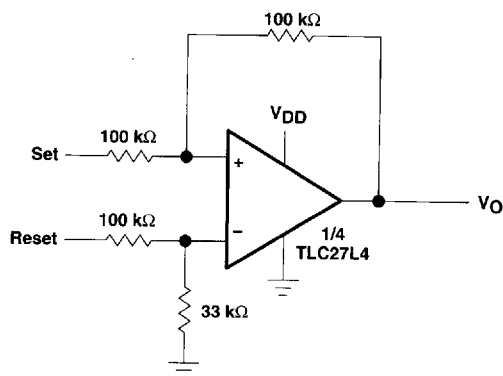

Figure 44. Multivibrator



NOTE: V_{DD} = 5 V to 16 V

Figure 45. Set/Reset Flip-Flop

8961724 0106693 465

 **TEXAS
INSTRUMENTS**

POST OFFICE BOX 655303 • DALLAS, TEXAS 75265

TLC27L4, TLC27L4A, TLC27L4B, TLC27L4Y, TLC27L9 LinCMOS™ PRECISION QUAD OPERATIONAL AMPLIFIERS

SLOS053C – OCTOBER 1987 – REVISED AUGUST 1994

APPLICATION INFORMATION

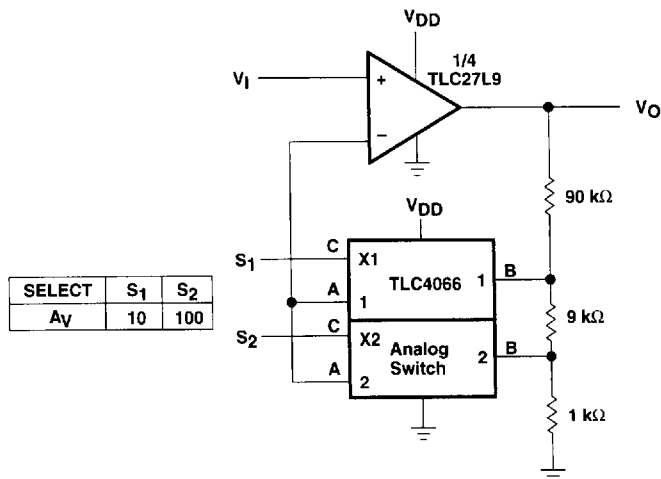

NOTE: $V_{DD} = 5\text{ V to }12\text{ V}$

Figure 46. Amplifier With Digital Gain Selection

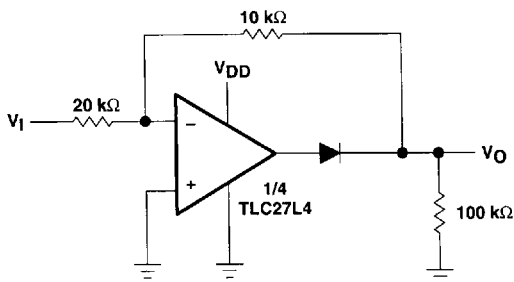

NOTE: $V_{DD} = 5\text{ V to }16\text{ V}$

Figure 47. Full-Wave Rectifier

8961724 0106694 3T1

**TEXAS
INSTRUMENTS**

POST OFFICE BOX 655303 • DALLAS, TEXAS 75285

TLC27L4, TLC27L4A, TLC27L4B, TLC27L4Y, TLC27L9
 LinCMOS™ PRECISION QUAD OPERATIONAL AMPLIFIERS

SLOS053C – OCTOBER 1987 – REVISED AUGUST 1994

APPLICATION INFORMATION

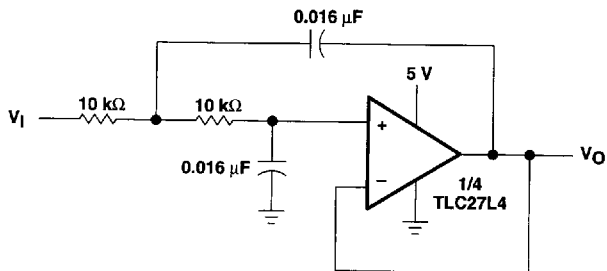

NOTE: Normalized to $F_C = 1$ kHz and $R_L = 10$ kΩ

Figure 48. Two-Pole Low-Pass Butterworth Filter

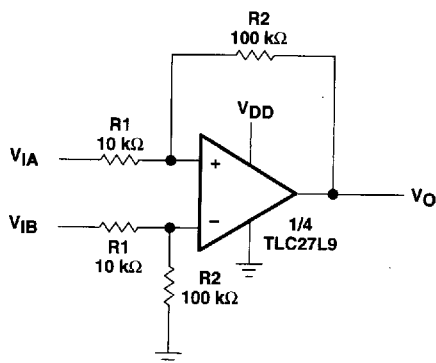

NOTE: $V_{DD} = 5$ V to 16 V

$$V_O = \frac{R_2}{R_1} (V_{IB} - V_{IA})$$

Figure 49. Difference Amplifier

8961724 0106695 238

 **TEXAS
INSTRUMENTS**

POST OFFICE BOX 655303 • DALLAS, TEXAS 75265