

# P54/74FCT374/A/C (P54/74PCT374/A/C) P54/74FCT574/A/C (P54/74PCT574/A/C) OCTAL D FLIP-FLOPS WITH 3-STATE OUTPUTS



## FEATURES

- Function, Pinout, and Drive Compatible with the FCT and F Logic
- FCT-C speed at 5.2ns max. (Com'I)  
FCT-A speed at 6.5ns max. (Com'I)
- CMOS  $V_{OH}$  Levels for Low Power Consumption — Typically 1/3 of FAST Bipolar Logic
- Edge-rate Control Circuitry for Significantly Improved Noise Characteristics
- ESD protection exceeds 2000V
- Inputs and Outputs Interface Directly with TTL, NMOS, and CMOS Devices
- Outputs Meet Levels Required for CMOS Static RAM Low Power Standby Mode
- 64 mA Sink Current (Com'I), 48 mA (MII)  
15 mA Source Current (Com'I), 12 mA (MII)
- Edge Triggered D Type Inputs
- 250MHz Typical Toggle Rate
- Buffered Positive Edge Trigered Clock
- Input Clamp Diode to Limit Bus Reflections
- Manufactured in 0.8 micron PACE Technology™



## DESCRIPTION

The 'FCT374 and 'FCT574 are high-speed low power octal D-type flip-flops featuring separate D-type inputs for each flip-flop. Both devices have 3-state outputs for bus oriented applications. A buffered clock (CP) and output enable ( $\overline{OE}$ ) are common to all flip-flops. The 'FCT574 is the same as the 'FCT374 except that all the outputs are on one side of the package and the inputs on the other side.

The eight flip-flops contained in the 'FCT374 and 'FCT574 will store the state of their individual D inputs that meet the setup and hold time requirements on the low-to-high clock (CP) transition. When  $\overline{OE}$  is LOW, the contents of the eight flip-flops are available at the outputs. When  $\overline{OE}$  is HIGH, the outputs will be in the high impedance state. The state of output enable does not affect the state of the flip-flops.



## LOGIC SYMBOL

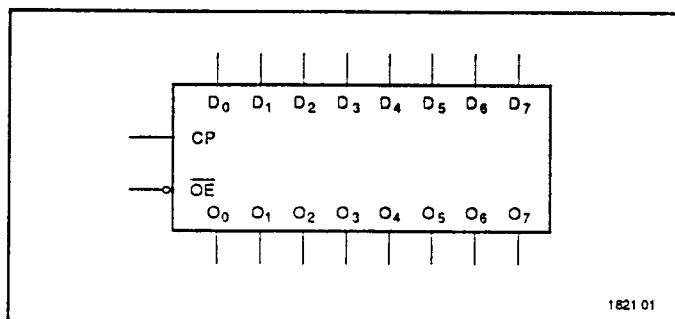

## LOGIC DIAGRAMS

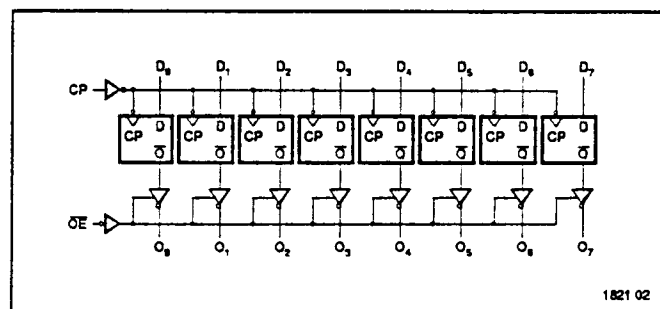

**PIN CONFIGURATIONS**

'FCT374

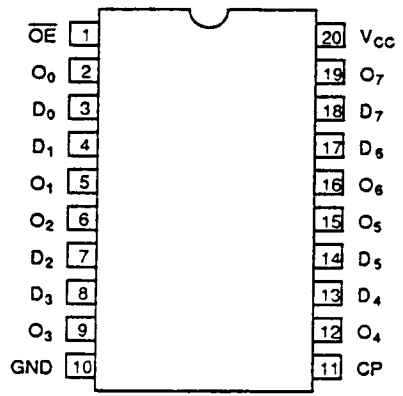

DIP(D2, P2)  
SOIC (S2)

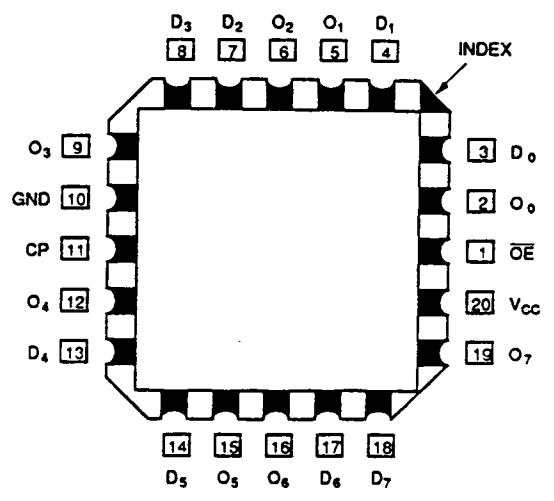

LCC(L2)

1821 03

'FCT574

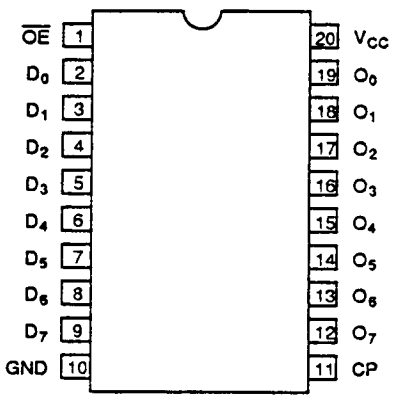

DIP(D2, P2)  
SOIC (S2)

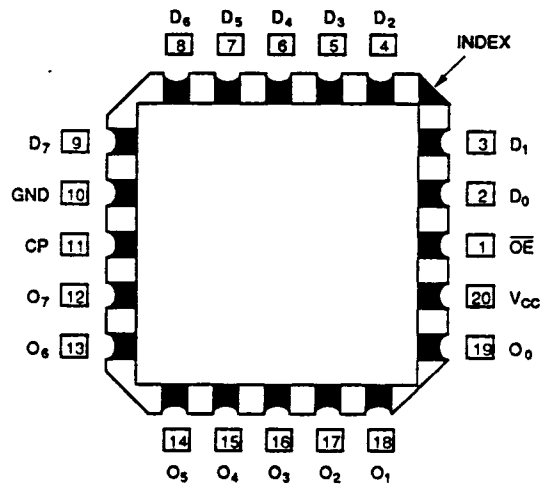

LCC(L2)

1821 04

**ABSOLUTE MAXIMUM RATINGS<sup>1,2</sup>**

Symbol	Parameter	Value	Unit
T <sub>STG</sub>	Storage Temperature	-65 to +150	°C
T <sub>A</sub>	Ambient Temperature Under Bias	-65 to +135	°C
V <sub>CC</sub>	V <sub>CC</sub> Potential to Ground	-0.5 to +7.0	V
I <sub>IN</sub>	Input Current	-30 to +5.0	mA

**Notes:**

1821 Tbl 01

1. Operation beyond the limits set forth in the above table may impair the useful life of the device. Unless otherwise noted, these limits are over the operating free-air temperature range.

**RECOMMENDED OPERATING CONDITIONS**

Free Air Ambient Temperature	Min	Max
Military	-55°C	+125°C
Commercial	0°C	+70°C

1821 Tbl 03

Symbol	Parameter	Value	Unit
I <sub>OUTPUT</sub>	Current Applied to Output	120	mA
V <sub>IN</sub>	Input Voltage	-0.5 to V <sub>CC</sub> + 0.5	V
V <sub>OUT</sub>	Voltage Applied to Output	-0.5 to V <sub>CC</sub> + 0.5	V

1821 Tbl 02

2. Unused inputs must always be connected to an appropriate logic voltage level, preferably either V<sub>CC</sub> or ground.

Supply Voltage (V <sub>CC</sub> )	Min	Max
Military	+4.5V	+5.5V
Commercial	+4.75V	+5.25V

1821 Tbl 04

**DC ELECTRICAL CHARACTERISTICS (Over recommended operating conditions)**

Symbol	Parameter	Min	Typ <sup>1</sup>	Max	Units	V <sub>CC</sub>	Conditions	
V <sub>IH</sub>	Input HIGH Voltage	2.0			V			
V <sub>IL</sub>	Input LOW Voltage			0.8	V			
V <sub>H</sub>	Hysteresis		0.35		V		All inputs	
V <sub>CD</sub>	Input Clamp Diode Voltage		-0.7	-1.2	V	MIN	I <sub>IN</sub> = -18mA	
V <sub>OH</sub>	Output HIGH Voltage	V <sub>CC</sub> = 3V, V <sub>IN</sub> = 0.2V, or V <sub>CC</sub> - 0.2V		V <sub>CC</sub> - 0.2	V <sub>CC</sub>	V	I <sub>OH</sub> = -32μA	
		Military/Commercial (CMOS)		V <sub>CC</sub> - 0.2	V <sub>CC</sub>	V	MIN I <sub>OH</sub> = -300μA	
		Military (TTL)		2.4	4.3	V	MIN I <sub>OH</sub> = -12mA	
		Commercial (TTL)		2.4	4.3	V	MIN I <sub>OH</sub> = -15mA	
V <sub>OL</sub>	Output LOW Voltage	V <sub>CC</sub> = 3V, V <sub>IN</sub> = 0.2V, or V <sub>CC</sub> - 0.2V			GND	0.2	V	I <sub>OL</sub> = 300μA
		Military/Commercial (CMOS)			GND	0.2	V	MIN I <sub>OL</sub> = 300μA
		Military (TTL)			0.3	0.5	V	MIN I <sub>OL</sub> = 32mA
		Commercial (TTL)			0.3	0.5	V	MIN I <sub>OL</sub> = 48mA
		Commercial (TTL)			0.3	0.5	V	MIN I <sub>OL</sub> = 64mA
I <sub>IH</sub>	Input HIGH Current			5	μA	MAX	V <sub>IN</sub> = V <sub>CC</sub>	
I <sub>IL</sub>	Input LOW Current			-5	μA	MAX	V <sub>IN</sub> = GND	
I <sub>IH</sub>	Input HIGH Current <sup>3</sup>			5	μA	MAX	V <sub>IN</sub> = 2.7V	
I <sub>IL</sub>	Input LOW Current <sup>3</sup>			-5	μA	MAX	V <sub>IN</sub> = 0.5V	
I <sub>OZH</sub>	Off State I <sub>OUT</sub> HIGH-Level Output Current			10	μA	MAX	V <sub>OUT</sub> = V <sub>CC</sub>	
I <sub>OZL</sub>	Off State I <sub>OUT</sub> LOW-Level Output Current			-10	μA	MAX	V <sub>OUT</sub> = GND	
I <sub>OZH</sub>	Off State I <sub>OUT</sub> HIGH-Level Output Current <sup>3</sup>			10	μA	MAX	V <sub>OUT</sub> = 2.7V	
I <sub>OZL</sub>	Off State I <sub>OUT</sub> LOW-Level Output Current <sup>3</sup>			-10	μA	MAX	V <sub>OUT</sub> = 0.5V	
I <sub>OS</sub>	Output Short Circuit Current <sup>2</sup>	-60	-120	-225	mA	MAX	V <sub>OUT</sub> = 0.0V	
C <sub>IN</sub>	Input Capacitance <sup>3</sup>		5	10	pF	MAX	All inputs	
C <sub>OUT</sub>	Output Capacitance <sup>3</sup>		9	12	pF	MAX	All outputs	

**Notes:**

1821 Tbl 05

- Typical limits are at V<sub>CC</sub> = 5.0V, T<sub>A</sub> = +25°C ambient.
- Not more than one output should be shorted at a time. Duration of short should not exceed one second. The use of high speed test apparatus and/or sample and hold techniques are preferable in order to minimize internal chip heating and more accurately reflect

operational values. Otherwise prolonged shorting of a high output may raise the chip temperature well above normal and thereby cause invalid readings in other parameter tests. In any sequence of parameter tests, I<sub>OS</sub> tests should be performed last.

- This parameter is guaranteed but not tested.

**DC CHARACTERISTICS** (Over recommended operating conditions unless otherwise specified.)

Symbol	Parameter	Typ <sup>1</sup>	Max	Units	Conditions
$I_{CC}$	Quiescent Power Supply Current (CMOS inputs)	0.003	0.5	mA	$V_{CC} = \text{MAX}$ , $f_1 = 0$ , Outputs Open, $V_{IN} \leq 0.2V$ or $V_{IN} \geq V_{CC} - 0.2V$
$\Delta I_{CC}$	Quiescent Power Supply Current (TTL inputs)	0.5	2.0	mA	$V_{CC} = \text{MAX}$ , $V_{IN} = 3.4V^2$ , $f_1 = 0$ , Outputs Open
$I_{CCD}$	Dynamic Power Supply Current <sup>3</sup>	0.15	0.25	mA/ mHz	$V_{CC} = \text{MAX}$ , One Bit Toggling, 50% Duty Cycle, Outputs Open, $\overline{OE} = \text{GND}$ , $V_{IN} \leq 0.2V$ or $V_{IN} \geq V_{CC} - 0.2V$
$I_C$	Total Power Supply Current <sup>5</sup>	1.7	4.0	mA	$V_{CC} = \text{MAX}$ , $f_0 = 10\text{MHz}$ 50% Duty Cycle, Outputs Open, One Bit Toggling at $f_1 = 5\text{MHz}$ , $\overline{OE} = \text{GND}$ , $V_{IN} \leq 0.2V$ or $V_{IN} \geq V_{CC} - 0.2V$
		2.2	6.0	mA	$V_{CC} = \text{MAX}$ , $f_0 = 10\text{MHz}$ 50% Duty Cycle, Outputs Open, One Bit Toggling at $f_1 = 5\text{MHz}$ , $\overline{OE} = \text{GND}$ , $V_{IN} = 3.4V$ or $V_{IN} = \text{GND}$
		4.0	7.8 <sup>4</sup>	mA	$V_{CC} = \text{MAX}$ , $f_0 = 10\text{MHz}$ 50% Duty Cycle, Outputs Open, Eight Bits Toggling at $f_1 = 2.5\text{MHz}$ , $\overline{OE} = \text{GND}$ , $V_{IN} \leq 0.2V$ or $V_{IN} \geq V_{CC} - 0.2V$
		6.2	16.8 <sup>4</sup>	mA	$V_{CC} = \text{MAX}$ , $f_0 = 10\text{MHz}$ 50% Duty Cycle, Outputs Open, Eight Bits Toggling at $f_1 = 2.5\text{MHz}$ , $\overline{OE} = \text{GND}$ , $V_{IN} = 3.4V$ or $V_{IN} = \text{GND}$

**Notes:**

- Typical values are at  $V_{CC} = 5.0V$ , +25°C ambient and maximum loading.
- Per TTL driven input ( $V_{IN} = 3.4V$ ); all other inputs at  $V_{CC}$  or GND.
- This parameter is not directly testable, but is derived for use in Total Power Supply calculations.
- Values for these conditions are examples of the  $I_{CC}$  formula. These limits are guaranteed but not tested.
- $I_C = I_{\text{QUIESCENT}} + I_{\text{INPUTS}} + I_{\text{DYNAMIC}}$   
 $I_C = I_{CC} + \Delta I_{CC} D_H N_T + I_{CCD} (f_0/2 + f_1 N_1)$   
 $I_{CC}$  = Quiescent Current with CMOS input levels

- $\Delta I_{CC}$  = Power Supply Current for a TTL High Input ( $V_{IN} = 3.4V$ )  
 $D_H$  = Duty Cycle for TTL Inputs High  
 $N_T$  = Number of TTL Inputs at  $D_H$   
 $I_{CCD}$  = Dynamic Current Caused by an Input Transition Pair (HLH or LHL)  
 $f_0$  = Clock Frequency for Register Devices (Zero for Non-Register Devices)  
 $f_1$  = Input Frequency  
 $N_1$  = Number of Inputs at  $f_1$   
 All currents are in milliamps and all frequencies are in megahertz.

1821 Tbl 06

**TRUTH TABLE**

Inputs			Outputs 'FCT374—'FCT574
$D_n$	CP	$\overline{OE}$	$O_n$
H		L	H
L		L	L
X	X	H	Z

- H = HIGH Voltage Level  
 L = LOW Voltage Level  
 X = Don't Care  
 = LOW-to-HIGH clock transition  
 Z = HIGH Impedance

1821 Tbl 07

## AC CHARACTERISTICS

Sym.	Parameter	'FCT374				'FCT374A				'FCT374C				Units	Fig. No.
		MIL		COM'L		MIL		COM'L		MIL		COM'L			
		Min. <sup>1</sup>	Max.	Min. <sup>1</sup>	Max.	Min. <sup>1</sup>	Max.	Min. <sup>1</sup>	Max.	Min. <sup>1</sup>	Max.	Min. <sup>1</sup>	Max.		
$t_{PLH}$ $t_{PHL}$	Prop. Delay Clock to Output	1.5	9.0	1.5	8.0	2.0	7.2	2.0	6.5	2.0	6.2	2.0	5.2	ns	1, 5
$t_{PZH}$ $t_{PZL}$	Output Enable Time	1.5	9.0	1.5	8.0	1.5	7.5	1.5	6.5	1.5	6.2	1.5	5.5	ns	1, 7, 8
$t_{PHZ}$ $t_{PLZ}$	Output Disable Time	1.5	8.0	1.5	8.0	1.5	6.5	1.5	5.5	1.5	5.7	1.5	5.0	ns	1, 7, 8

1821 Tbl 09

## Note:

1. AC Characteristics guaranteed with  $C_L = 50\text{pF}$  as shown in Figure 1.

## AC CHARACTERISTICS

Sym.	Parameter	'FCT574				'FCT574A				'FCT574C				Units	Fig. No.
		MIL		COM'L		MIL		COM'L		MIL		COM'L			
		Min. <sup>1</sup>	Max.	Min. <sup>1</sup>	Max.	Min. <sup>1</sup>	Max.	Min. <sup>1</sup>	Max.	Min. <sup>1</sup>	Max.	Min. <sup>1</sup>	Max.		
$t_{PLH}$ $t_{PHL}$	Prop. Delay Clock to Output	2.0	11.0	2.0	10.0	2.0	7.2	2.0	6.5	2.0	6.2	2.0	5.2	ns	1, 5
$t_{PZH}$ $t_{PZL}$	Output Enable Time	1.5	14.0	1.5	12.5	1.5	7.5	1.5	6.5	1.5	6.2	1.5	5.5	ns	1, 7, 8
$t_{PHZ}$ $t_{PLZ}$	Output Disable Time	1.5	8.0	1.5	8.0	1.5	6.5	1.5	5.5	1.5	5.7	1.5	5.0	ns	1, 7, 8

1821 Tbl 09

## Note:

1. AC Characteristics guaranteed with  $C_L = 50\text{pF}$  as shown in Figure 1.

## AC CHARACTERISTICS

Sym.	Parameter	'FCT374 'FCT574				'FCT374A 'FCT574A				'FCT374C 'FCT574C				Units	Fig. No.
		MIL		COM'L		MIL		COM'L		MIL		COM'L			
		Min. <sup>1</sup>	Max.	Min. <sup>1</sup>	Max.	Min. <sup>1</sup>	Max.	Min. <sup>1</sup>	Max.	Min. <sup>1</sup>	Max.	Min. <sup>1</sup>	Max.		
$t_{s(H)}$ $t_{s(L)}$	Setup Time, High or Low $D_n$ to CP	2.5	–	2.0	–	2.0	–	2.0	–	2.0	–	2.0	–	ns	4
$t_{h(H)}$ $t_{h(L)}$	Hold Time, High or Low $D_n$ to CP	1.0	–	1.0	–	1.5	–	1.5	–	1.5	–	1.5	–	ns	
$t_{w(H)}$ $t_{w(L)}$	Clk Pulse Width <sup>2</sup> High or Low	7.0	–	6.0	–	6.0	–	5.0	–	6.0	–	5.0	–	ns	5

1821 Tbl 10

## Notes:

1. Minimum limits are guaranteed but not tested on Propagation Delays.
2. With one data channel toggling,  $t_{v(L)} = t_{v(H)} = 2.0\text{ns}$  and  $t_r = t_f = 1.0\text{ns}$ .

### ORDERING INFORMATION

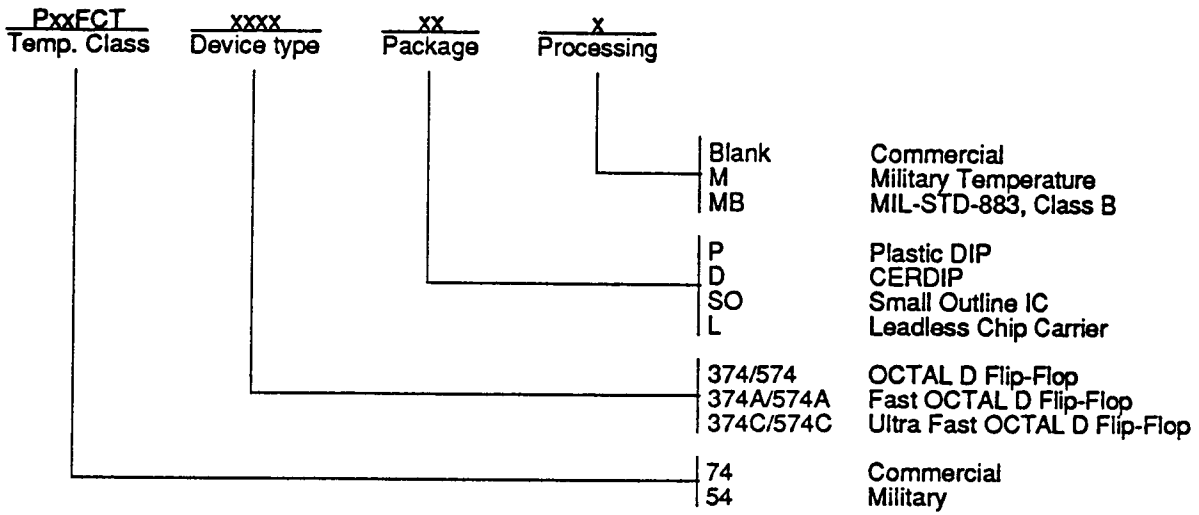

1821 05

032276 ✓