



MBR20100C

DIODE

SCHOTTKY BARRIER RECTIFIER

FEATURES

- * 20 Amps Total (10 Amps Per Diode Leg)
- * Guard Ring for Transient Protection
- * Low Forward Voltage Drop
- * High Surge Capability
- * Low Power Loss/High Efficiency

SYMBOL

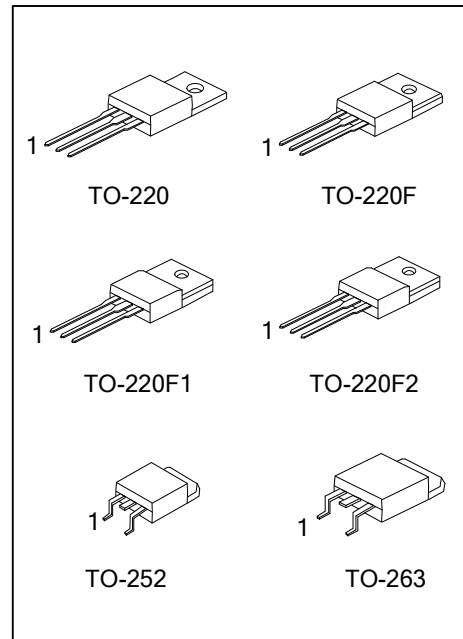
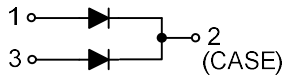

ORDERING INFORMATION

Ordering Number		Package	Pin Assignment			Packing
Lead Free	Halogen Free		1	2	3	
MBR20100CL-TA3-T	MBR20100CG-TA3-T	TO-220	A	K	A	Tube
MBR20100CL-TF3-T	MBR20100CG-TF3-T	TO-220F	A	K	A	Tube
MBR20100CL-TF1-T	MBR20100CG-TF1-T	TO-220F1	A	K	A	Tube
MBR20100CL-TF2-T	MBR20100CG-TF2-T	TO-220F2	A	K	A	Tube
MBR20100CL-TN3-R	MBR20100CG-TN3-R	TO-252	A	K	A	Tape Reel
MBR20100CL-TQ2-T	MBR20100CG-TQ2-T	TO-263	A	K	A	Tube
MBR20100CL-TQ2-R	MBR20100CG-TQ2-R	TO-263	A	K	A	Tape Reel

Note: Pin Assignment: G: Gate D: Drain S: Source

<p>MBR20100CG-TA3-T</p> <p>(1) Packing Type</p> <p>(2) Package Type</p> <p>(3) Green Package</p>	<p>(1) T: Tube, R: Tape Reel</p> <p>(2) TA3: TO-220, TF3: TO-220F, TF1: TO-220F1, TF2: TO-220F2, TN3: TO-252, TQ2: TO-263</p> <p>(3) G: Halogen Free and Lead Free, L: Lead Free</p>
--	--

MARKING

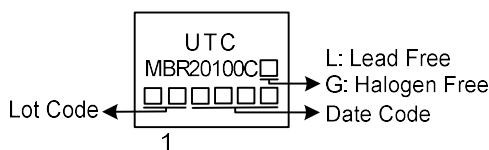

■ ABSOLUTE MAXIMUM RATINGS (T_A=25°C, unless otherwise specified)

PARAMETER		SYMBOL	RATINGS	UNIT
Maximum Repetitive Peak Reverse Voltage		V _{RRM}	100	V
Maximum DC Blocking Voltage		V _R	100	V
Working Peak Reverse Voltage		V _{RWM}	100	V
Maximum PMS Reverse Voltage		V _{R(RMS)}	70	V
Average Forward Rectified Output Current	Per Leg	I _O	10	A
	Total		20	A
Non-Repetitive Peak Forward Surge Current 8.3ms Single Half-Sine-Wave		I _{FSM}	150	A
Junction Capacitance (Note 4)		C _J	1000	pF
Operating Temperature		T _J	-55 ~ +150	°C
Storage Temperature		T _{STG}	-55 ~ +150	°C

■ THERMAL DATA (Pre Diode)

PARAMETER		SYMBOL	RATINGS	UNIT
Junction to Ambient	TO-220/TO-220F TO-220F1/TO-220F2 TO-263	θ _{JA}	55	°C/W
	TO-252		100	°C/W
	TO-220/TO-263		2	°C/W
Junction to Case	TO-220F/TO-220F1 TO-220F2	θ _{JC}	4	°C/W
	TO-252		3	°C/W

■ ELECTRICAL CHARACTERISTICS

PARAMETER	SYMBOL	TEST CONDITIONS	MIN	TYP	MAX	UNIT
Instantaneous Forward Voltage Drop (Note 3)	V _F	I _F =10A, T _C =25°C			0.85	V
		I _F =10A, T _C =125°C			0.75	V
Instantaneous Reverse Current (Note 3)	I _R	Rated DC Voltage, T _C =25°C			0.15	mA
		Rated DC Voltage, T _C =125°C		0.5	10	mA

- Notes: 1. Absolute maximum ratings are those values beyond which the device could be permanently damaged. Absolute maximum ratings are stress ratings only and functional device operation is not implied.
2. 2.0μs Pulse Width, f = 1.0KHz.
 3. Pulse Test: Pulse Width=300μs, Duty Cycle ≤ 2.0%.
 4. Applied V_R = 4.0V and f = 1.0MHZ.

TYPICAL CHARACTERISTICS

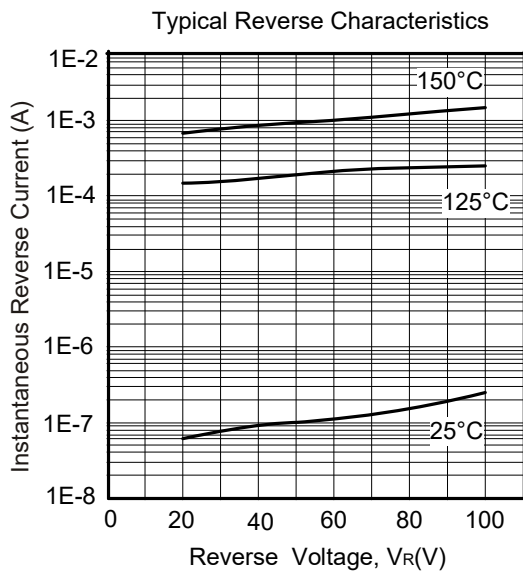
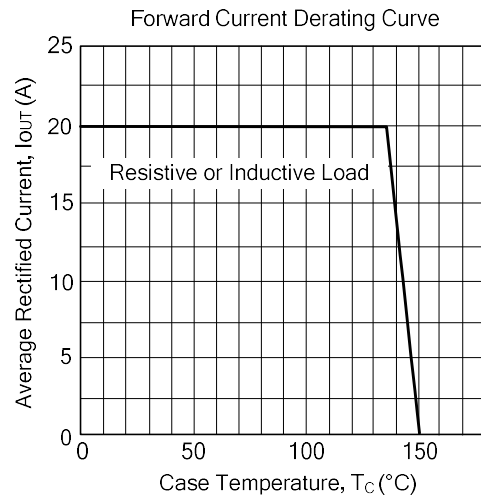
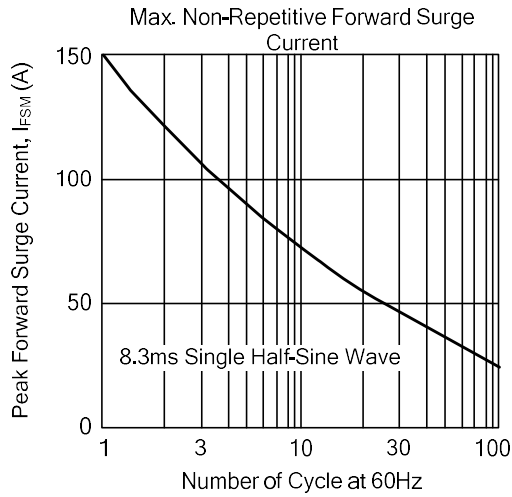
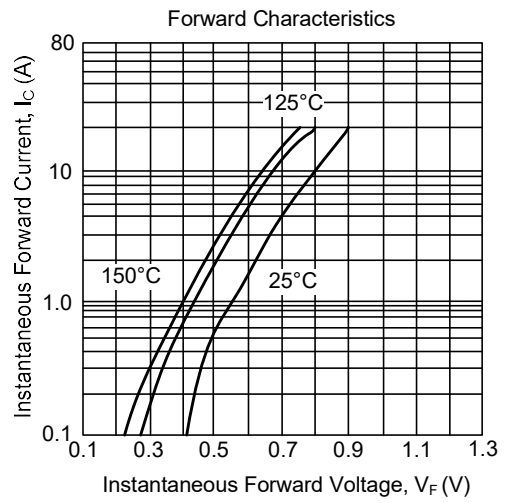
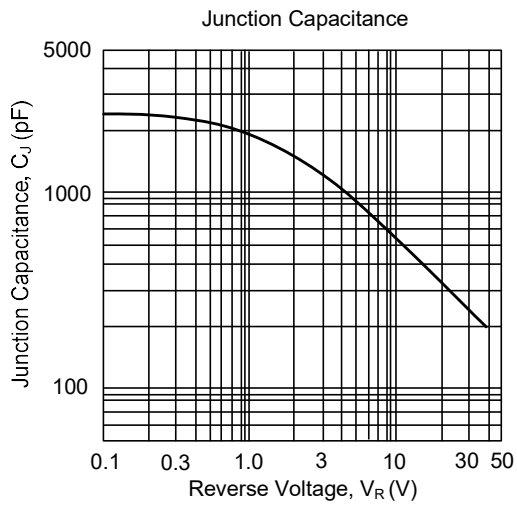

UTC assumes no responsibility for equipment failures that result from using products at values that exceed, even momentarily, rated values (such as maximum ratings, operating condition ranges, or other parameters) listed in products specifications of any and all UTC products described or contained herein. UTC products are not designed for use in life support appliances, devices or systems where malfunction of these products can be reasonably expected to result in personal injury. Reproduction in whole or in part is prohibited without the prior written consent of the copyright owner. UTC reserves the right to make changes to information published in this document, including without limitation specifications and product descriptions, at any time and without notice. This document supersedes and replaces all information supplied prior to the publication hereof.