

Small Signal Zener Diode

General Description

These diodes small signal Zener diodes, fabricated in planar technology. Miniature surface mount package is excellent for hand-held and portable applications where is space is limited.



SOD-323

Features and Benefits

- Silicon epitaxial planar diode
- Low Zener impedance and low leakage current
- Standard Zener voltage tolerance is 4.3%.
- Full lead (Pb)-free device and RoHS compliant device
- Available in "Green" device



Applications

- Voltage regulator

Ordering Information

| Part Number | Marking Code | Package | Packaging |
|-------------|--------------|---------|-------------|
| SDZ6V2D | Z4 □ | SOD-323 | Tape & Reel |

Marking Information

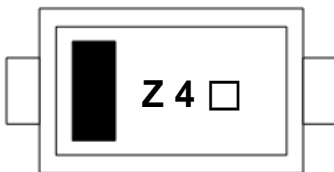

Z 4 = Specific Device Code

□ = Year & Week Code Marking

■ = Color band denote cathode

Pinning Information

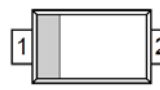
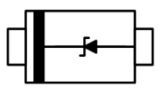
| Pin | Description | Simplified Outline | Graphic Symbol |
|-----|-------------|--|---|
| 1 | Cathode |  |  |
| 2 | Anode | | |

Absolute Maximum Ratings ($T_{amb}=25^{\circ}\text{C}$, Unless otherwise specified)

| Characteristic | Symbol | Ratings | Unit |
|---------------------------------|-----------|-------------|------|
| Power dissipation ¹⁾ | P_D | 200 | mW |
| Operating junction temperature | T_J | 150 | °C |
| Storage temperature range | T_{stg} | -55 to +150 | |

¹⁾ Device mounted on FR-4 board with recommended pad layout.

Thermal Characteristics ($T_{amb}=25^{\circ}\text{C}$, Unless otherwise specified)

| Characteristic | Symbol | Ratings | Unit |
|---|---------------|---------|------|
| Thermal resistance, junction to ambient ¹⁾ | $R_{th(j-a)}$ | 625 | °C/W |

¹⁾ Device mounted on FR-4 board with recommended pad layout.

Electrical Characteristics ($T_{amb}=25^{\circ}\text{C}$, Unless otherwise specified)

| Characteristic | Symbol | Test Condition | Min. | Typ. | Max. | Unit |
|-------------------------|----------|---------------------|------|------|------|------|
| Zener voltage | V_Z | $I_Z=5\text{mA}$ | 5.93 | - | 6.47 | V |
| Dynamic impedance | Z_{ZT} | $I_Z=5\text{mA}$ | - | - | 15 | Ω |
| KNEE dynamic impedance | Z_{ZK} | $I_Z=0.25\text{mA}$ | - | - | 1300 | |
| Reverse leakage current | I_R | $V_R=4\text{V}$ | - | - | 1 | μA |

Rating and Characteristic Curves

Fig. 1) Typical Zener Characteristics

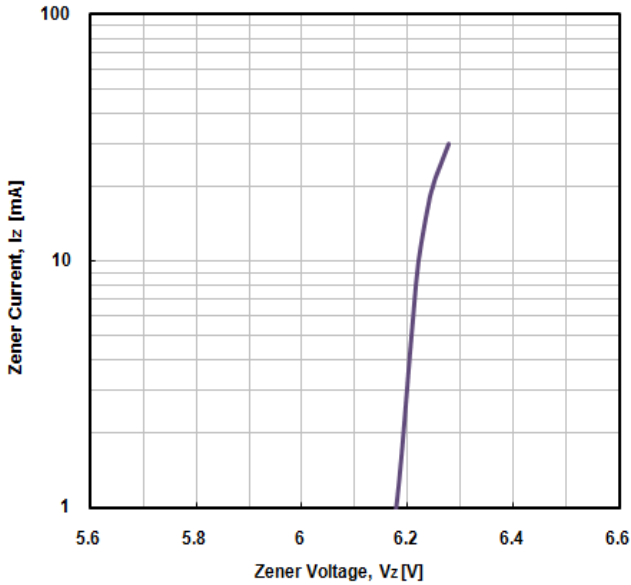

Fig. 2) Zener voltage vs. Ambient Temperature

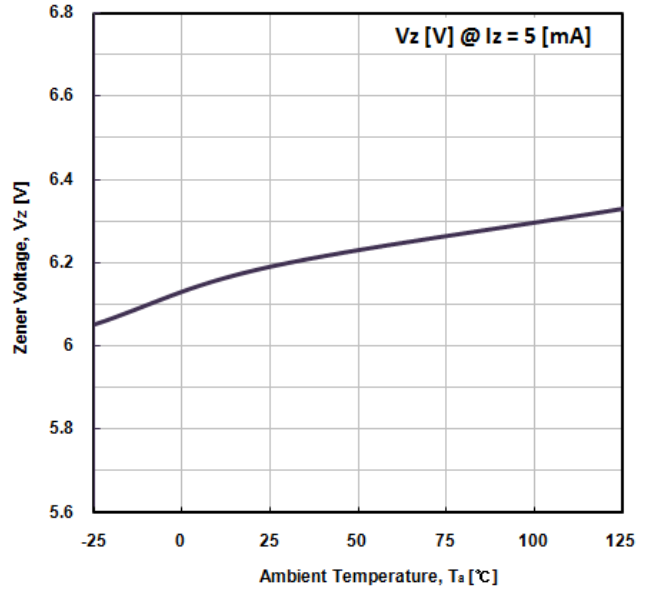

Fig. 3) Typical Capacitance Characteristics

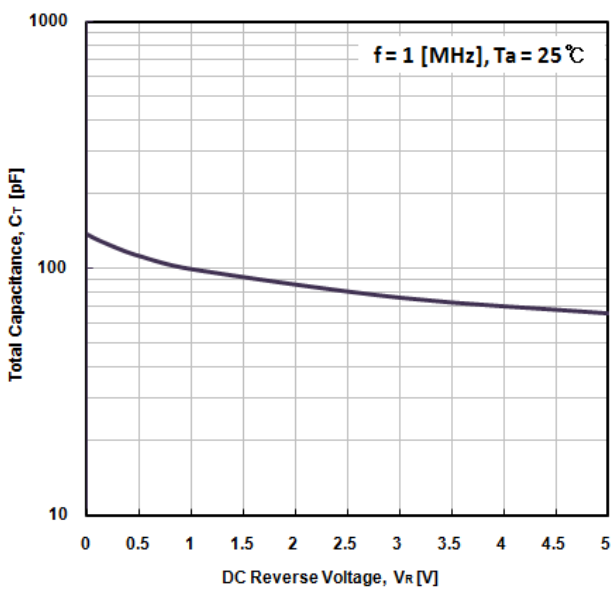
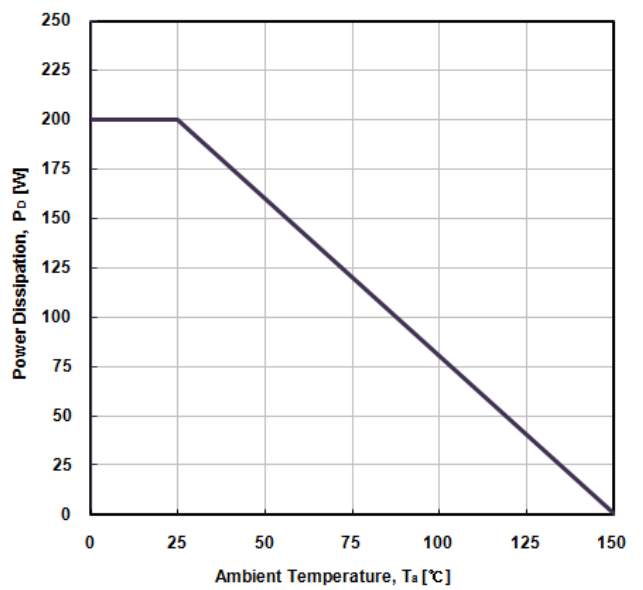
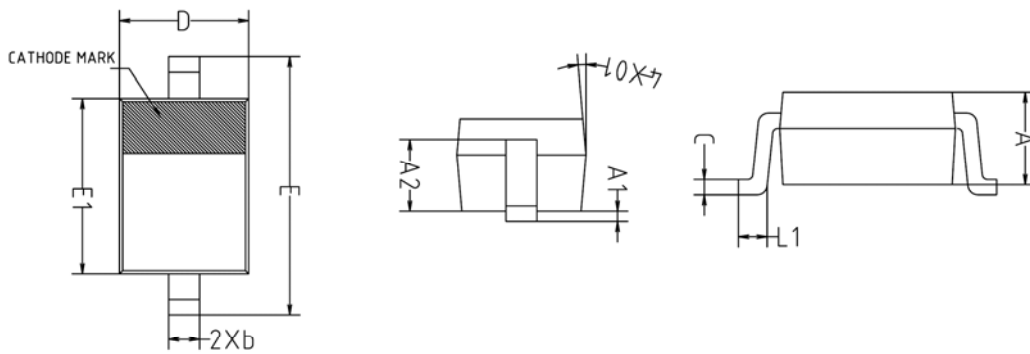

Fig. 4) Power Dissipation vs. Ambient Temperature



Package Outline Dimensions (Unit : mm)



| SYMBOL | MILLIMETERS | | | NOTE |
|--------|-------------|---------|---------|------|
| | MINIMUM | NOMINAL | MAXIMUM | |
| A | 0.850 | - | 0.950 | |
| A1 | 0.000 | - | 0.100 | |
| A2 | 0.650 | 0.700 | 0.750 | |
| b | 0.250 | 0.300 | 0.350 | |
| c | 0.110 | 0.150 | 0.190 | |
| D | 1.200 | 1.250 | 1.300 | |
| E | 2.400 | 2.500 | 2.600 | |
| E1 | 1.650 | 1.700 | 1.750 | |
| L1 | 0.200 | - | 0.300 | |
| ∅2 | 5° REF | | | |

※ Recommend PCB solder land (Unit : mm)

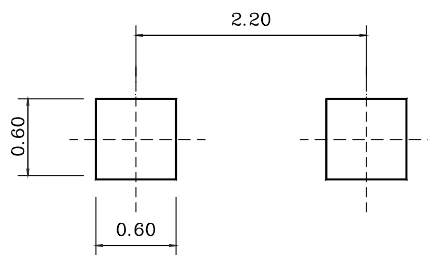

The AUK Corp. products are intended for the use as components in general electronic equipment (Office and communication equipment, measuring equipment, home appliance, etc.).

Please make sure that you consult with us before you use these AUK Corp. products in equipments which require high quality and / or reliability, and in equipments which could have major impact to the welfare of human life(atomic energy control, airplane, spaceship, transportation, combustion control, all types of safety device, etc.). AUK Corp. cannot accept liability to any damage which may occur in case these AUK Corp. products were used in the mentioned equipments without prior consultation with AUK Corp..

Specifications mentioned in this publication are subject to change without notice.