

TOSHIBA MOS DIGITAL INTEGRATED CIRCUIT SILICON GATE CMOS

524,288-WORD BY 18-BIT SYNCHRONOUS NO-TURNAROUND STATIC RAM

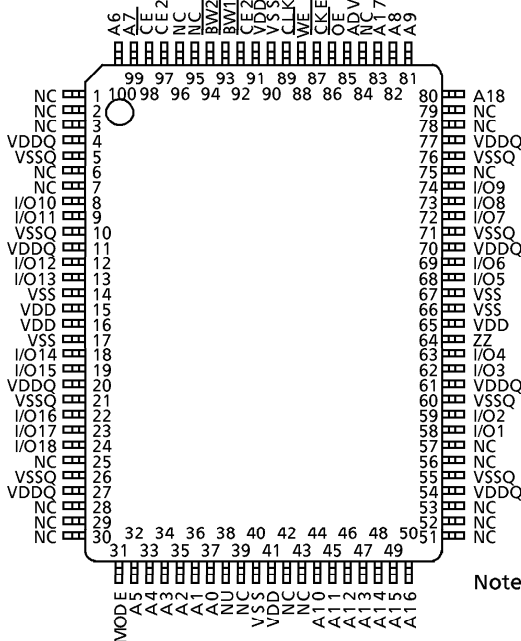
**DESCRIPTION**

The TC55VL818FF is a synchronous static random access memory(SRAM) organized as 524,288 words by 18 bits. NtRAM™(no-turnaround) SRAM offers high bandwidth by eliminating dead cycles during the transition from a read to a write and vice versa. All inputs except Output Enable OE and the Snooze pin ZZ are synchronized with the rising edge of the CLK input. A Read operation is initiated by the ADV Address Advanced Input signal; the input from the address pins and all control pins except the OE and ZZ pins are loaded into the internal registers on the rising edge of CLK in the cycle in which ADV is asserted. The output data is available in the same clock cycle as that in which ADV is asserted. Write operations are internally self-timed and are initiated by the rising edge of CLK in the cycle in which ADV is asserted. The input from the address pins and all control pins except the OE and ZZ pins are loaded into the internal registers on the rising edge of CLK in the cycle in which ADV is asserted. Input data is loaded in the cycle following the cycle in which ADV is asserted. Byte Write Enables(BW1 to BW2) allow from one to four Byte Write operations to be performed. A 2-bit burst address counter and control logic are integrated into this SRAM. The TC55VL818FF uses a single power supply(3.3V) or dual power supplies(3.3V for core and 2.5V for output buffer) and is available in a 100-pin low-profile plastic QFP(LQFP).

**FEATURES**

- Organized as 524,288 words by 18 bits
- Fast cycle time of 12 ns minimum (83 MHz maximum)
- Fast access time of 9 ns maximum (from clock edge to data output)
- No-turnaround operation with flow-through data output
- 2-bit burst address counter (support for interleaved or linear burst sequences)
- Synchronous self-timed Write
- Byte Write control
- Snooze mode pin(ZZ) for power down
- LVTTTL-compatible interface
- Single power supply (3.3 V) or Dual power supplies(3.3V for core and 2.5V for output buffer)
- Available in 100-pin LQFP package (LQFP100-P-1420-0.65K ; pitch:0.65 mm, height:1.6 mm, weight:0.56 grams(typical))

**PIN ASSIGNMENT (TOP VIEW)**



**PIN NAMES**

CLK	Clock Input
A0 to A18	Address Inputs
CE, CE2, CE2	Chip Enable Inputs
OE	Output Enable
WE	Write Enable Input
BW1 to BW2	Byte Write Enable
ADV	Address Advance Input
CKE	Clock Enable
ZZ	Snooze Input
I/O1 to I/O18	Data Inputs/Outputs
MODE	Mode Select Input
NC	Not Connected
NU	Not Usable
V <sub>DD</sub>	Power Supply for Core
V <sub>DDQ</sub>	Power Supply for Output Buffer
V <sub>SS</sub>	Ground for Core
V <sub>SSQ</sub>	Ground for Output Buffer

Note : NtRAM™ and No-Turnaround Random Access Memory are trademarks of Samsung Electronics Co., Ltd.. The architecture and functionality are supported by Samsung and NEC.

000707EBA2

● TOSHIBA is continually working to improve the quality and reliability of its products. Nevertheless, semiconductor devices in general can malfunction or fail due to their inherent electrical sensitivity and vulnerability to physical stress. It is the responsibility of the buyer, when utilizing TOSHIBA products, to comply with the standards of safety in making a safe design for the entire system, and to avoid situations in which a malfunction or failure of such TOSHIBA products could cause loss of human life, bodily injury or damage to property. In developing your designs, please ensure that TOSHIBA products are used within specified operating ranges as set forth in the most recent TOSHIBA products specifications. Also, please keep in mind the precautions and conditions set forth in the "Handling Guide for Semiconductor Devices," or "TOSHIBA Semiconductor Reliability Handbook" etc..

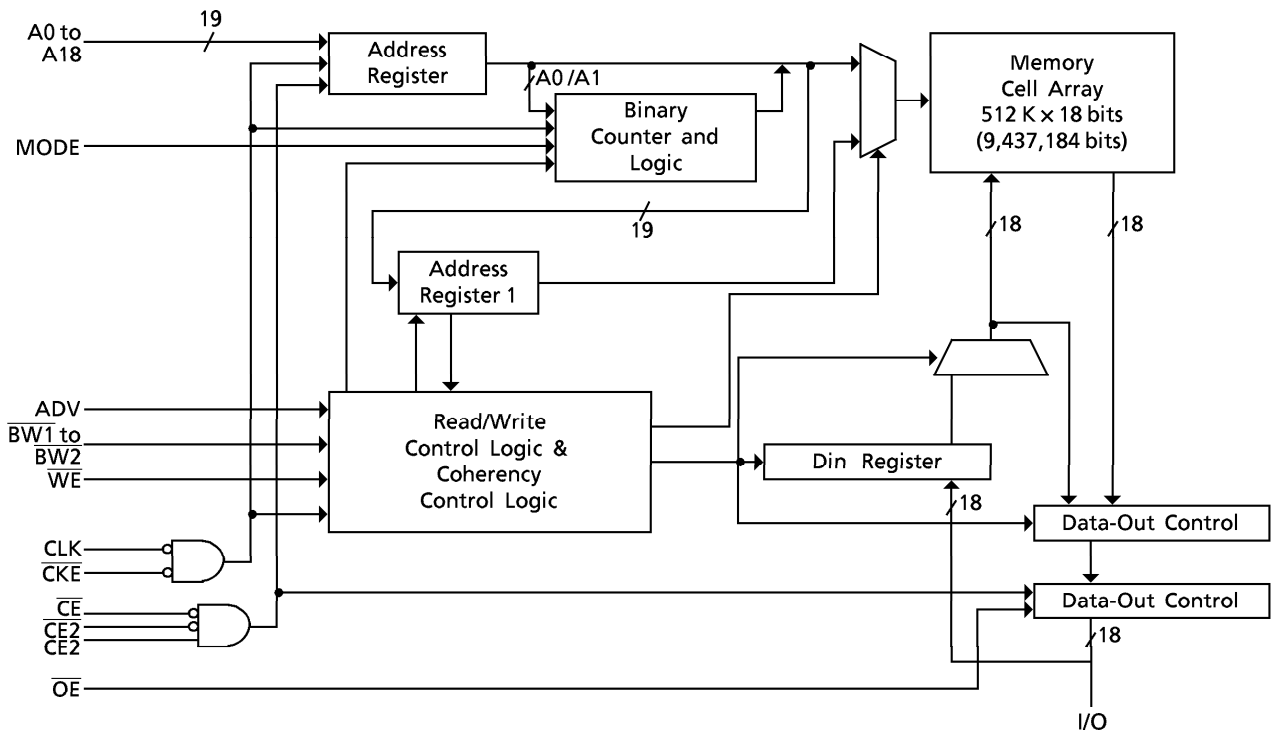
● The TOSHIBA products listed in this document are intended for usage in general electronics applications (computer, personal equipment, office equipment, measuring equipment, industrial robotics, domestic appliances, etc.). These TOSHIBA products are neither intended nor warranted for usage in equipment that requires extraordinarily high quality and/or reliability or a malfunction or failure of which may cause loss of human life or bodily injury ("Unintended Usage"). Unintended Usage include atomic energy control instruments, airplane or spaceship instruments, transportation instruments, traffic signal instruments, combustion control instruments, medical instruments, all types of safety devices, etc.. Unintended Usage of TOSHIBA products listed in this document shall be made at the customer's own risk.

● The products described in this document are subject to the foreign exchange and foreign trade laws.

● The information contained herein is presented only as a guide for the applications of our products. No responsibility is assumed by TOSHIBA CORPORATION for any infringements of intellectual property or other rights of the third parties which may result from its use. No license is granted by implication or otherwise under any intellectual property or other rights of TOSHIBA CORPORATION or others.

● The information contained herein is subject to change without notice.

**BLOCK DIAGRAM**



## PIN DESCRIPTIONS

PIN NUMBER	SYMBOL	TYPE	DESCRIPTION
89	CLK	Input (NA)	<b>Clock Input</b> All synchronous input signals are registered on the rising edge of CLK. When the chip is enabled, address inputs and control pins except for $\overline{OE}$ and ZZ must meet the specified setup and hold times with respect to the CLK rising edge.
37, 36, 35, 34, 33, 32, 100, 99, 82, 81, 44, 45, 46, 47, 48, 49, 50, 83, 80	A0 to A18	Input (synchronous)	<b>Address Inputs</b> These address inputs are registered on the rising edge of CLK. When the chip is enabled, address inputs must meet the specified setup and hold times with respect to the CLK rising edge.
98	$\overline{CE}$	Input (synchronous)	<b>Chip Enable Input</b> This active-Low signal controls the chip status (enabled or disabled). It is sampled only when a new external address is loaded.
92	$\overline{CE2}$	Input (synchronous)	<b>Chip Enable Input</b> This active-Low signal controls the chip status (enabled or disabled). It is sampled only when a new external address is loaded.
97	CE2	Input (synchronous)	<b>Chip Enable Input</b> This active-High signal controls the chip status (enabled or disabled). It is sampled only when a new external address is loaded.
86	$\overline{OE}$	Input (asynchronous)	<b>Output Enable Input</b> This active-Low signal control all 18-bits I/O output buffer.
88	$\overline{WE}$	Input (synchronous)	<b>Write Enable Input</b> This active-Low input controls Read/Write operations.
93, 94	$\overline{BW1}$ to $\overline{BW2}$	Input (synchronous)	<b>Byte Write Enable</b> These active-Low inputs control Byte Write operations when a Write cycle is active. A Byte Write pin controls I/O pins as follows. $\overline{BW1}$ : I/O1 to I/O9 $\overline{BW2}$ : I/O10 to I/O18
85	ADV	Input (synchronous)	<b>Address Advance Input</b> This is used to load the internal registers with the input from the address and control signals when it is Low on the rising edge of CLK. When it is High, the internal burst address counter is incremented. The external address inputs are ignored when this signal is High.
87	$\overline{CKE}$	Input (synchronous)	<b>Clock Enable</b> When High, CLK input is ignored and outputs retain the same state.

PIN NUMBER	SYMBOL	TYPE	DESCRIPTION
64	ZZ	Input (asynchronous)	<b>Snooze Input</b> This active-High signal is used to place the device into Sleep Mode (Low-Power Standby Mode). When Low, the device remains in the Active state. When High, the device goes into the Sleep state and memory data is retained. After this signal has been deasserted, the device will wake up when a Read or Write operation is initiated by ADV.
58, 59, 62, 63, 68, 69, 72, 73, 74, 8, 9, 12, 13, 18, 19, 22, 23, 24	I/O1 to I/O32	I/O (synchronous)	<b>Data Input/Output</b>
31	MODE	Input (synchronous)	<b>Mode Select Input</b> This signal selects the burst sequence. When High, the burst sequence is interleaved. When Low, it is linear sequence.
1, 2, 3, 6, 7, 25, 28, 29, 30, 39, 42, 43, 51, 52, 53, 56, 57, 75, 78, 79, 84, 95, 96	NC	NC	<b>Not Connected</b>
38	NU	Input (asynchronous)	<b>Not Usable</b>
15, 16, 41, 65, 91	V <sub>DD</sub>	Supply	<b>Power Supply for Core</b>
4, 11, 20, 27, 54, 61, 70, 77	V <sub>DDQ</sub>	Supply	<b>Power Supply for Output Buffers</b>
14, 17, 40, 66, 67, 90	V <sub>SS</sub>	Ground	<b>Ground for Core</b>
5, 10, 21, 26, 55, 60, 71, 76	V <sub>SSQ</sub>	Ground	<b>Ground for Output Buffers</b>

## OPERATING MODE

### (1) Synchronous Input Truth Table

OPERATION	$\overline{WE}$	ADV	CE	$\overline{BW}$	Addr. Used	$\overline{CKE}$	ZZ	I/O (6)
Read (begin burst)	H	L	Select	x	External	L	L	Output
Read (Continue burst)	x	H	x	x	Internal	L	L	Output
Write (begin burst)	L	L	Select	L	External	L	L	Input
Write (continue burst)	x	H	x	L	Internal	L	L	Input
NOP/Write Abort (begin burst)	L	L	Select	H	x	L	L	Hi-Z
Write Abort (continue burst)	x	H	x	H	Internal	L	L	Hi-Z
Deselected	x	L	Deselect	x	x	L	L	Hi-Z
Deselect Continue (Note 2)	x	H	x	x	x	L	L	Hi-Z
Ignore Clock Edge (Note 3)	x	x	x	x	x	H	L	Previous value
Snooze	x	x	x	x	x	x	H	Hi-Z

Notes: 1. H means logical High and L means logical Low. X means Don't care.

2. A Deselect Continued cycle can only be entered if a Deselect cycle is executed before it.

3. When the Ignore Clock Edge command is asserted during a Read operation, the output data for the previous cycle still appear on the I/O pins. When the command is asserted during a Write operation, the I/O pins remain at Hi-Z, and the Write operation is not executed.

4. All synchronous Inputs must exhibit adequate setup and hold times either side of the rising edge of the CLK pin.

5. The data output appears in the same cycle as that in which the Read command is asserted. Data input is triggered on the rising edge of CLK in the next following the one in which the Write command is asserted.

6. ZZ input is asynchronous, but is included in this table.

### (2) Write Enable Truth Table

OPERATION	$\overline{WE}$	$\overline{BW1}$	$\overline{BW2}$	I/O1 to I/O9	I/O10 to I/O18
Read	H	x	x	Output	Output
Write	L	L	L	Input	Input
	L	L	H	Input	Hi-Z
	L	H	L	Hi-Z	Input
	L	H	H	Hi-Z	Hi-Z

Notes: 1. H means logical High and L means logical Low. X means Don't care.

### (3) Asynchronous Inputs Truth Table

OPERATION	$\overline{OE}$	ZZ	I/O
Read	L	L	Dout
	H	L	Hi-Z
Write	x	L	Din, Hi-Z
Stop clock (Note 2)	H	L	Hi-Z
	L	L	Low-Z
Snooze (Note 3)	x	H	Hi-Z

Notes: 1. H means logical High and L means logical Low. X means Don't care.

2. The Stop CLK Mode achieves Low Power Standby by stopping the input clock.

3. The Snooze Mode achieves Low Power Standby by asserting the ZZ pin.

4. The cycle immediately prior to a Snooze brought about by the ZZ pin must be a Read Mode or Deselect Mode cycle.

5. Memory data is retained during Snooze Mode cycles.

### (4) Burst Sequence

MODE PIN	BURST OPERATION
L	Linear burst order
H or NC	Interleaved burst order

a) Linear Burst Sequence (MODE input =  $V_{SS}$ )  
 Bit Order:  $A_{18}, \dots, A_1, A_0$

1st Address (external)	2nd Address (internal)	3rd Address (internal)	4th Address (internal)
XX ..... XX00	XX ..... XX01	XX ..... XX10	XX ..... XX11
XX ..... XX01	XX ..... XX10	XX ..... XX11	XX ..... XX00
XX ..... XX10	XX ..... XX11	XX ..... XX00	XX ..... XX01
XX ..... XX11	XX ..... XX00	XX ..... XX01	XX ..... XX10

b) Interleaved Burst Sequence (MODE input =  $V_{DD}$  or NC)  
 Bit Order:  $A_{18}, \dots, A_1, A_0$

1st Address (external)	2nd Address (internal)	3rd Address (internal)	4th Address (internal)
XX ..... XX00	XX ..... XX01	XX ..... XX10	XX ..... XX11
XX ..... XX01	XX ..... XX00	XX ..... XX11	XX ..... XX10
XX ..... XX10	XX ..... XX11	XX ..... XX00	XX ..... XX01
XX ..... XX11	XX ..... XX10	XX ..... XX01	XX ..... XX00

**DEVICE OPERATION**

(1) Read Operation

CYCLE	ADDRESS	$\overline{WE}$	$\overline{BW}$	ADV	$\overline{CE}$	$\overline{OE}$	$\overline{CKE}$	I/O	OPERATION
n	A0	H	x	L	L	x	L	x	Address & control valid
n+1	x	x	x	x	x	L	L	Q0	Read out A0

Note 1: H means logical High and L means logical Low. X means Don't care. Q is data output.

(2) Burst Read Operation

CYCLE	ADDRESS	$\overline{WE}$	$\overline{BW}$	ADV	$\overline{CE}$	$\overline{OE}$	$\overline{CKE}$	I/O	OPERATION
n	A0	H	x	L	L	x	L	x	Address & control valid
n+1	x	x	x	H	x	L	L	Q0	Read out A0
n+2	x	x	x	H	x	L	L	Q0+1	Read out A0+1
n+3	x	x	x	H	x	L	L	Q0+2	Read out A0+2
n+4	x	x	x	H	x	L	L	Q0+3	Read out A0+3
n+5	A1	H	x	L	L	L	L	Q0	Read out A0
n+6	x	x	x	H	x	L	L	Q1	Read out A1
n+7	A2	H	x	L	L	L	L	Q1+1	Read out A1+1

Note 1: H means logical High and L means logical Low. X means Don't care. Q is data output.

(3) Write Operation

CYCLE	ADDRESS	$\overline{WE}$	$\overline{BW}$	ADV	$\overline{CE}$	$\overline{OE}$	$\overline{CKE}$	I/O	OPERATION
n	A0	L	L	L	L	x	L	x	Address & control valid
n+1	x	x	x	x	x	x	L	D0	Write to A0

Note 1: H means logical High and L means logical Low. X means Don't care. D is data input.

(4) Burst Write Operation

CYCLE	ADDRESS	$\overline{WE}$	$\overline{BW}$	ADV	$\overline{CE}$	$\overline{OE}$	$\overline{CKE}$	I/O	OPERATION
n	A0	L	L	L	L	x	L	x	Address & control valid
n+1	x	x	L	H	x	x	L	D0	Write A0
n+2	x	x	L	H	x	x	L	D0+1	Write A0+1
n+3	x	x	L	H	x	x	L	D0+2	Write A0+2
n+4	x	x	L	H	x	x	L	D0+3	Write A0+3
n+5	A1	L	L	L	L	x	L	D0	Write A0
n+6	x	x	L	H	x	x	L	D1	Write A1
n+7	A2	L	L	L	L	x	L	D1+1	Write A1+1

Note 1: H means logical High and L means logical Low. X means Don't care. D is data input.

(5) Read Operation with Clock Enable

CYCLE	ADDRESS	$\overline{WE}$	$\overline{BW}$	ADV	$\overline{CE}$	$\overline{OE}$	$\overline{CKE}$	I/O	OPERATION
n	A0	H	x	L	L	x	L	x	Address & control valid
n+1	x	x	x	x	x	x	H	x	Ignore cycle
n+2	A1	H	x	L	L	L	L	Q0	A0 read out
n+3	x	x	x	x	x	L	H	Q0	Ignore clock
n+4	x	x	x	x	x	L	H	Q0	Ignore clock
n+5	A2	H	x	L	L	L	L	Q1	Read out A1
n+6	A3	H	x	L	L	L	L	Q2	Read out A2
n+7	A4	H	x	L	L	L	L	Q3	Read out A3

Note 1: H means logical High and L means logical Low. X means Don't care. Q is data output.

(6) Write Operation with Clock Enable

CYCLE	ADDRESS	$\overline{WE}$	$\overline{BW}$	ADV	$\overline{CE}$	$\overline{OE}$	$\overline{CKE}$	I/O	OPERATION
n	A0	L	L	L	L	x	L	x	Add. & control valid
n+1	x	x	x	x	x	x	H	x	Ignore clock
n+2	A1	L	L	L	L	x	L	D0	Write A0
n+3	x	x	x	x	x	x	H	x	Ignore clock
n+4	x	x	x	x	x	x	H	x	Ignore clock
n+5	A2	L	L	L	L	x	L	D1	Write A1
n+6	A3	L	L	L	L	x	L	D2	Write A2
n+7	x	x	x	x	x	x	L	D3	Write A3

Note 1: H means logical High and L means logical Low. X means Don't care. D is data input.

(7) Read Operation with Chip Enable

CYCLE	ADDRESS	$\overline{WE}$	$\overline{BW}$	ADV	$\overline{CE}$	$\overline{OE}$	$\overline{CKE}$	I/O	OPERATION
n	A0	H	x	L	L	x	L	x	Address & control valid
n+1	x	x	x	L	H	L	L	Q0	Read A0
n+2	A1	H	x	L	L	x	L	Z	Deselect
n+3	x	x	x	L	H	L	L	Q1	Read A1
n+4	x	x	x	L	H	x	L	Z	Deselect
n+5	A2	H	x	L	L	x	L	Z	Deselect
n+6	x	x	x	L	H	L	L	Q2	Read A2
n+7	x	x	x	L	H	x	L	Z	Deselect

Note 1: H means logical High and L means logical Low. X means Don't care. Q is data output. Z means Hi-Z.

(8) Write Operation with Chip Enable

CYCLE	ADDRESS	$\overline{WE}$	$\overline{BW}$	ADV	$\overline{CE}$	$\overline{OE}$	$\overline{CKE}$	I/O	OPERATION
n	A0	L	L	L	L	x	L	x	Address & control valid
n+1	x	x	x	L	H	x	L	D0	Write A0
n+2	A1	L	L	L	L	x	L	Z	Deselect
n+3	x	x	x	L	H	x	L	D1	Write A1
n+4	x	x	x	L	H	x	L	Z	Deselect
n+5	A2	L	L	L	L	x	L	Z	Deselect
n+6	x	x	x	L	H	x	L	D2	Write A2
n+7	x	x	x	L	H	x	L	Z	Deselect

Note 1: H means logical High and L means logical Low. X means Don't care. D is data input. Z means Hi-Z.



ABSOLUTE MAXIMUM RATINGS

SYMBOL	RATING	VALUE	UNIT
$V_{DD}$	Power Supply Voltage	- 0.5 to 4.6	V
$V_{DDQ}$	Output Buffer Power Supply Voltage	- 0.5 to $V_{DD} + 0.5$ ( $\leq 4.6$ V max)	V
$V_{IN}$	Input Terminal Voltage	- 0.5 * to 4.6	V
$V_{IO}$	Input/Output Terminal Voltage	- 0.5 * to $V_{DDQ} + 0.5^{**}$ ( $\leq 4.6$ V max)	V
$P_D$	Power Dissipation	1.5	W
$T_{solder}$	Soldering Temperature (10 s)	260	°C
$T_{strg}$	Storage Temperature	- 65 to 150	°C
$T_{opr}$	Operating Temperature	- 10 to 85	°C

\*: -1.0 V with a pulse width of 20% of  $t_{KC}(\min)$  (3 ns max)

\*\* :  $V_{DDQ} + 1.0$  V with a pulse width of 20% of  $t_{KC}(\min)$  (3 ns max)

RECOMMENDED DC OPERATING CONDITIONS (Ta = 0 to 70°C)

SYMBOL	PARAMETER	MIN	TYP.	MAX	UNIT
$V_{DD}$	Power Supply Voltage	3.135	3.3	3.465	V
$V_{DDQ}$	Output Buffer Power Supply Voltage	3.135	3.3	3.465	V
$V_{IH}$	Input High Voltage	2.0	-	$V_{DD} + 0.3^{**}$	V
$V_{IH1}$	Input High Voltage for MODE pin	$V_{DD} - 0.3$	$V_{DD}$	$V_{DD} + 0.3$	V
$V_{IL}$	Input Low Voltage	- 0.3 *	-	0.8	V
$V_{IL1}$	Input Low Voltage for MODE and NU pins	- 0.3	0.0	0.3	V

\*: -0.7 V with a pulse width of 20% of  $t_{KC}(\min)$  (3 ns max)

\*\* :  $V_{DDQ} + 0.7$  V with a pulse width of 20% of  $t_{KC}(\min)$  (3 ns max)

Note: NU pin must be low or not connected.

**DC CHARACTERISTICS** ( $T_a = 0$  to  $70^\circ\text{C}$ ,  $V_{DD} = V_{DDQ} = 3.3\text{ V} \pm 5\%$ )

SYMBOL	PARAMETER	TEST CONDITIONS	MIN	TYP.	MAX	UNIT	
$I_{IL}$	Input Leakage Current	$V_{IN} = 0$ to $V_{DD}$	-1	-	1	$\mu\text{A}$	
$I_{NU}$	Input Current (NU pin)	$V_{IN} = 0\text{ V}$ to $0.3\text{ V}$	-1	-	1	$\mu\text{A}$	
$I_{LO}$	Output Leakage Current	Device Deselected or Output Deselected, $V_{OUT} = 0$ to $V_{DDQ}$	-1	-	1	$\mu\text{A}$	
$V_{OH}$	Output High Voltage	$I_{OH} = -8\text{ mA}$	2.4	-	-	V	
		$I_{OH} = -100\ \mu\text{A}$	$V_{DDQ} - 0.2$	-	-		
$V_{OL}$	Output Low Voltage	$I_{OL} = 8\text{ mA}$	-	-	0.4		
		$I_{OL} = 100\ \mu\text{A}$	-	-	0.2		
$I_{DDO1}$	Operating Current	$I_{OUT} = 0\text{ mA}$ , all inputs = $V_{DD} - 0.2\text{ V}/0.2\text{ V}$ Clock $\geq t_{KC}(\text{min})$	83MHz	-	-	240	mA
			75MHz	-	-	230	
$I_{DDO2}$	Operating Current (idle)	Device Deselected $I_{OUT} = 0\text{ mA}$ , all inputs = $V_{DD} - 0.2\text{ V}/0.2\text{ V}$ Clock $\geq t_{KC}(\text{min})$	83MHz	-	-	110	mA
			75MHz	-	-	100	
$I_{DDS1}$	Standby Current (TTL level)	Clock = $V_{SS}$ , all inputs = $V_{IH}$ or $V_{IL}$	-	-	60	mA	
$I_{DDS2}$	Standby Current (MOS level)	Clock = $V_{SS}$ , all inputs = $V_{DD} - 0.2\text{ V}$ or $0.2\text{ V}$	-	-	10	mA	
$I_{DDS3}$	Standby Current (Snooze Mode)	$ZZ \geq V_{DD} - 0.2\text{ V}$ All inputs = $V_{DD} - 0.2\text{ V}$ or $0.2\text{ V}$ Clock $\geq t_{KC}(\text{min})$	-	-	10	mA	
$I_{DDS4}$	Standby Current (CKE Mode)	$\overline{CKE} \geq V_{IH}$ All inputs = $V_{DD} - 0.2\text{ V}$ or $0.2\text{ V}$ Clock $\geq t_{KC}(\text{min})$	-	-	10	mA	

Note: Operating Current( $I_{DDO1}$ ) is specified with 50% Read cycles and 50% Write cycles.

**CAPACITANCE** ( $T_a = 25^\circ\text{C}$ ,  $f = 1.0\text{ MHz}$ )

SYMBOL	PARAMETER	TEST CONDITION	MAX	UNIT
$C_{IN}$	Input Capacitance	$V_{IN} = \text{GND}$	5	pF
$C_{I/O}$	Input/Output Capacitance	$V_{I/O} = \text{GND}$	7	pF
$C_{NU}$	Input Capacitance of NU	$V_{IN} = \text{GND}$	10	pF

Note: This parameter is sampled periodically and is not tested for every device.

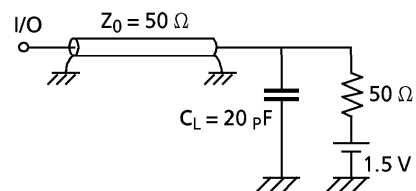
**AC CHARACTERISTICS** ( $T_a = 0$  to  $70^\circ\text{C}$ ,  $V_{DD} = V_{DDQ} = 3.3\text{ V} \pm 5\%$ )

SYMBOL	PARAMETER	TC55VL818FF-83		TC55VL818FF-75		UNIT
		MIN	MAX	MIN	MAX	
$t_{KC}$	CLK Cycle Time	12	–	13	–	ns
$t_{KH}$	CLK High Pulse Width	4	–	4	–	
$t_{KL}$	CLK Low Pulse Width	4	–	4	–	
$t_{KQV}$	CLK High to Output Valid	–	9	–	10	
$t_{KQX}$	CLK High to Output Invalid	3	–	3	–	
$t_{KQLZ}$	CLK High to Output Low-Z	4	–	4	–	
$t_{KQHZ}$	CLK High to Output High-Z	–	5	–	5	
$t_{GQV}$	$\overline{OE}$ Low to Output Valid	–	5	–	6	
$t_{GQLZ}$	$\overline{OE}$ Low to Output Low-Z	0	–	0	–	
$t_{GQHZ}$	$\overline{OE}$ High to Output High-Z	–	5	–	6	
$t_{AS}$	Address Setup Time from CLK	2	–	2	–	
$t_{DS}$	Data Setup Time from CLK	1.5	–	1.7	–	
$t_{WS}$	$\overline{WE}$ Setup Time from CLK	2	–	2	–	
$t_{CES}$	CE Setup Time from CLK	2	–	2	–	
$t_{ADVS}$	ADV Setup Time from CLK	2	–	2	–	
$t_{BWS}$	$\overline{BW}$ Setup Time from CLK	2	–	2	–	
$t_{CKES}$	$\overline{CKE}$ Setup Time from CLK	2	–	2	–	
$t_{AH}$	Address Hold Time from CLK	0.5	–	0.5	–	
$t_{DH}$	Data Hold Time from CLK	0.5	–	0.5	–	
$t_{WH}$	$\overline{WE}$ Hold Time from CLK	0.5	–	0.5	–	
$t_{CEH}$	CE Hold Time from CLK	0.5	–	0.5	–	
$t_{ADVH}$	ADV Hold Time from CLK	0.5	–	0.5	–	
$t_{BWH}$	$\overline{BW}$ Hold Time from CLK	0.5	–	0.5	–	
$t_{CKEH}$	$\overline{CKE}$ Hold Time from CLK	0.5	–	0.5	–	
$t_{ZZ}$	ZZ High to Input Ignored	0	$2t_{KC}$	0	$2t_{KC}$	
$t_{ZZR}$	ZZ Low to Input Sampled	0	$2t_{KC}$	0	$2t_{KC}$	
$t_{ZZHZ}$	ZZ High to Output High-Z	0	$2t_{KC}$	0	$2t_{KC}$	
$t_{ZZLZ}$	ZZ Low to Output Low-Z	0	–	0	–	

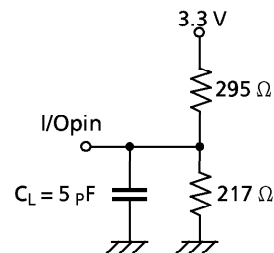
**AC TEST CONDITIONS**

Input Pulse Level	3.0 V/0.0 V
Input Pulse Rise and Fall Time	1 V/ns(20%/80%)
Input Timing Measurement Reference Level	1.5 V
Output Timing Measurement Reference Level	1.5 V
Output Load	As shown in Fig. 1 and Fig. 2

**Fig. 1 : AC test load**

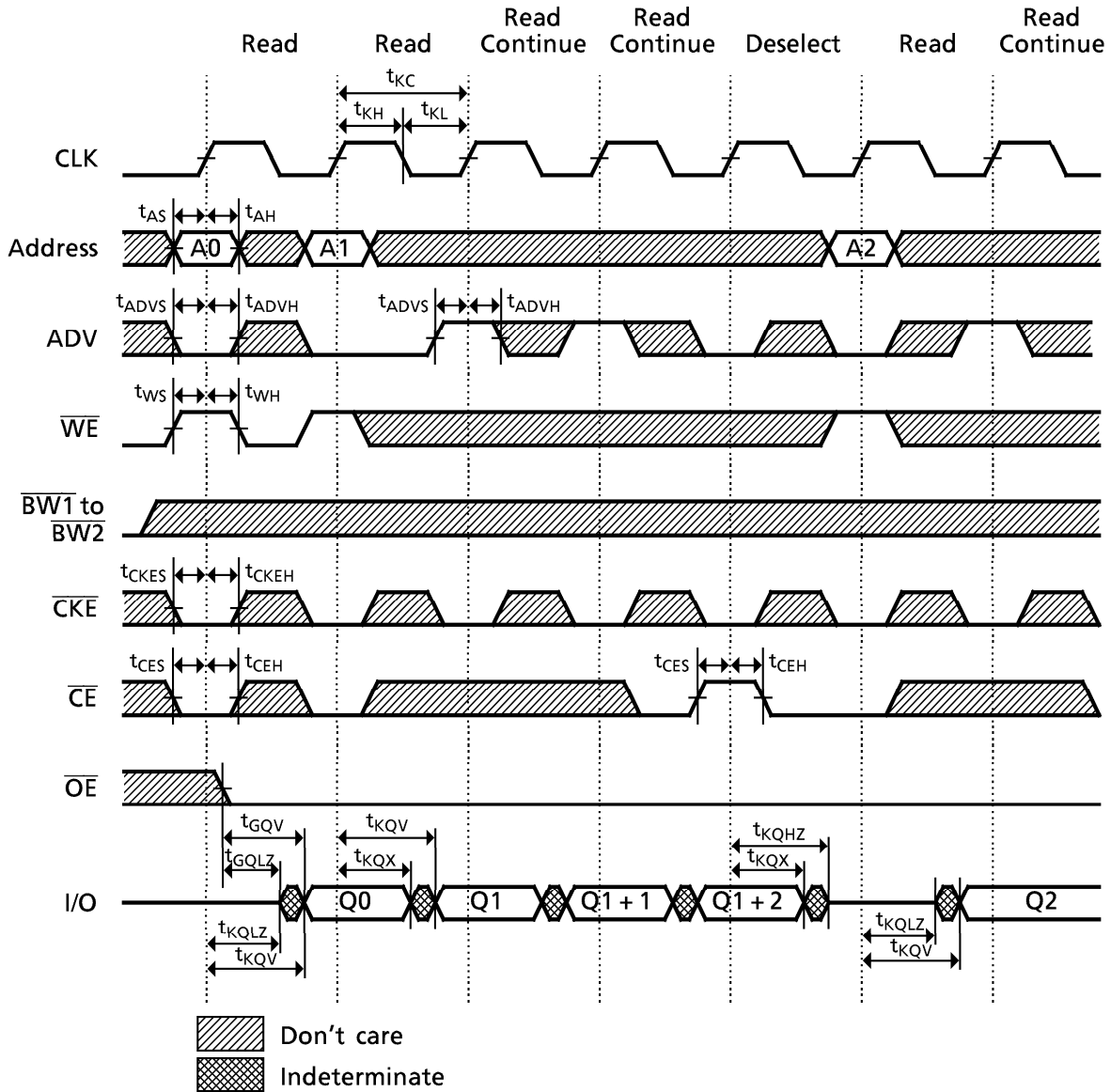


**Fig. 2 : AC test load (for Enable/Disable spec)**

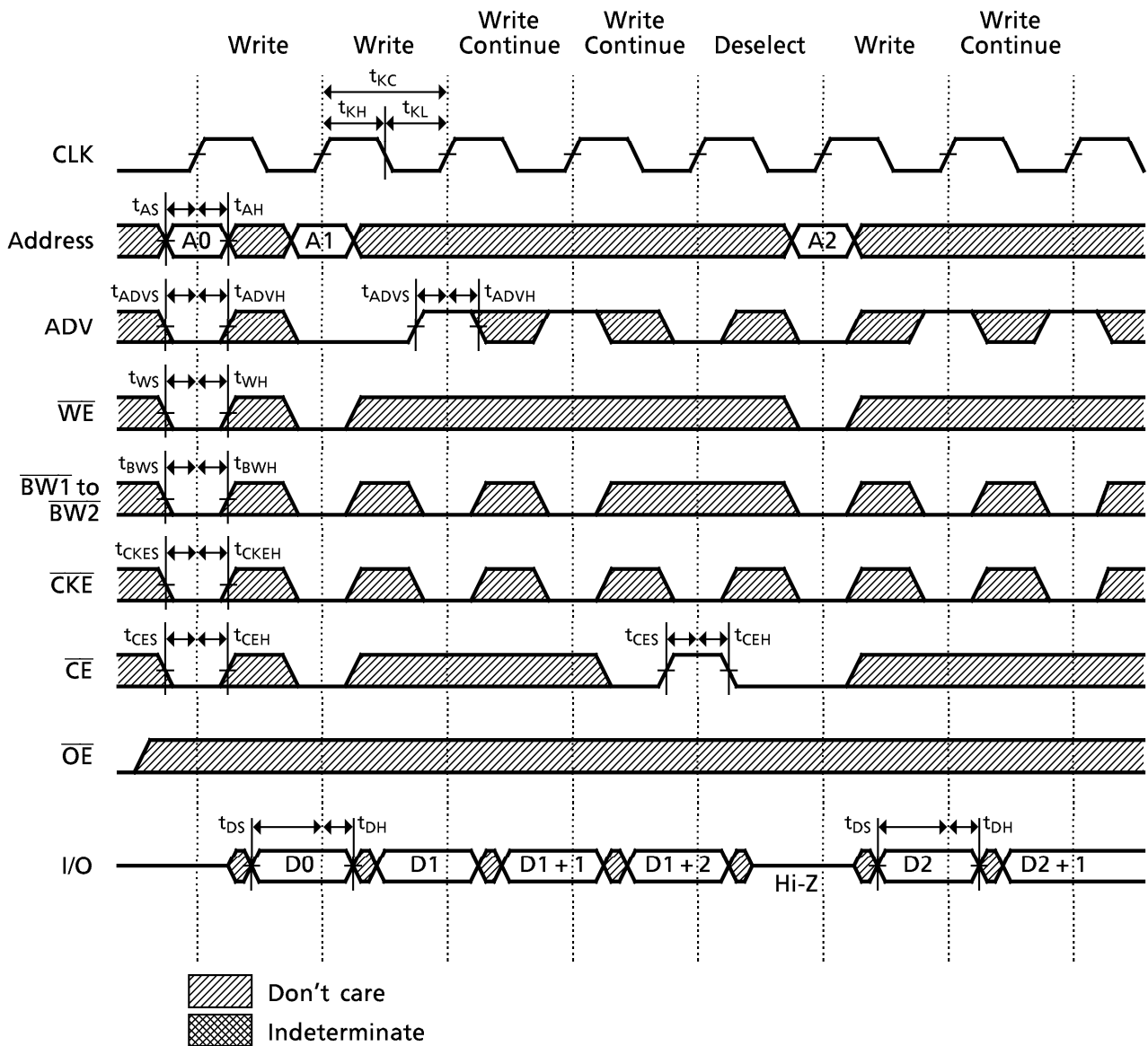


**TIMING DIAGRAMS**

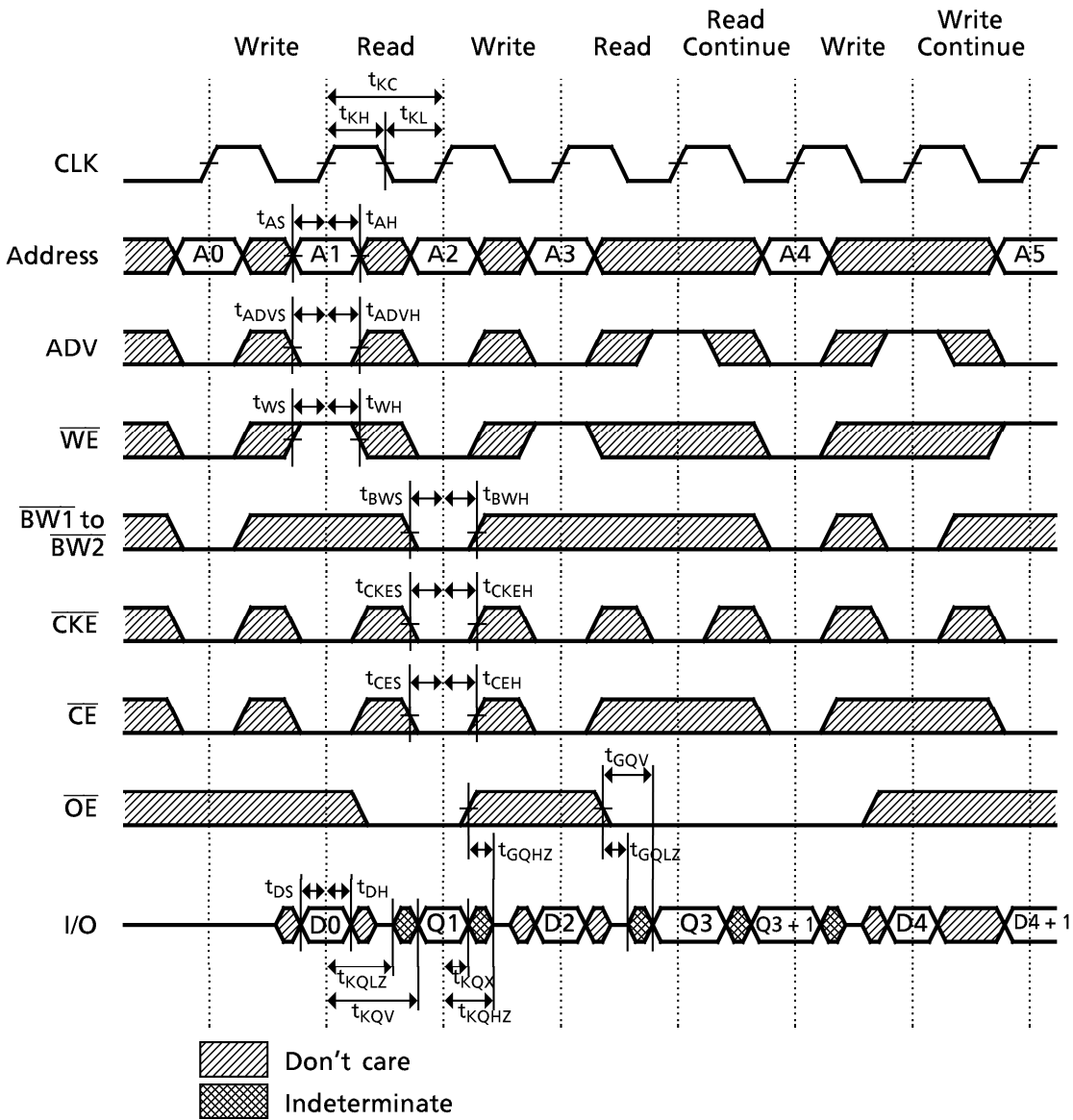
**READ CYCLE**



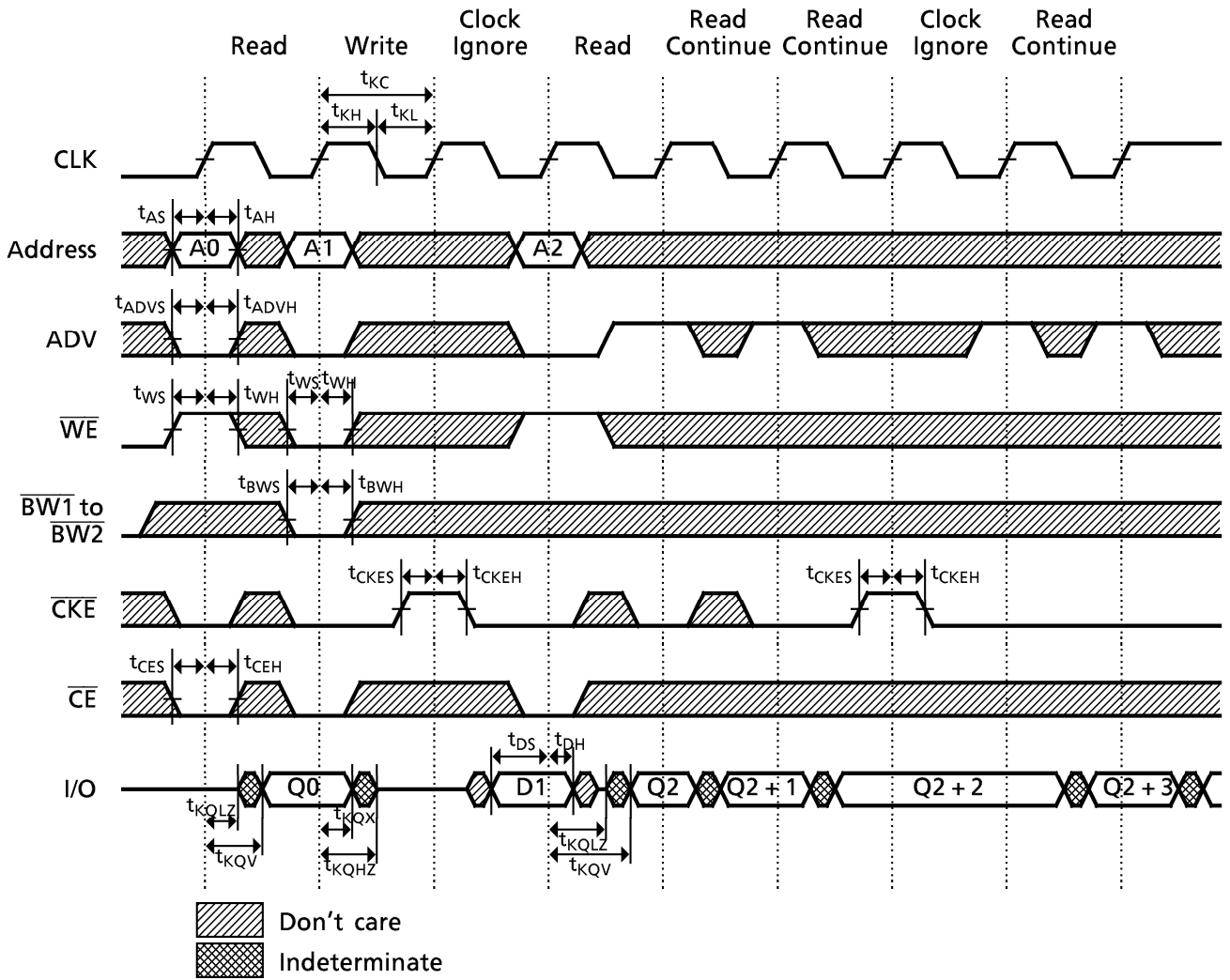
WRITE CYCLE



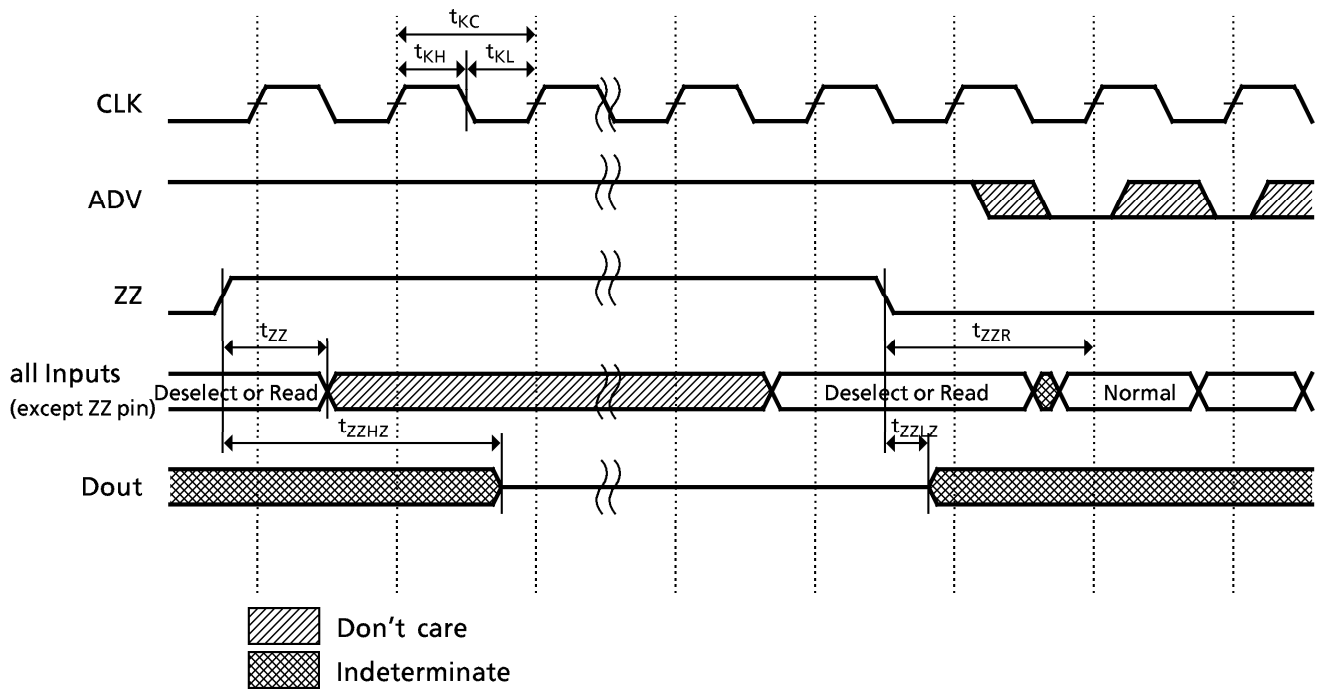
WRITE/READ CYCLE



CLOCK IGNORE CYCLE



SNOOZE CYCLE



Notes: 1. The cycle immediately prior to a Snooze brought about by the ZZ pin must be a Read cycle or Deselect cycle.

2. Memory data is retained during Snooze cycles.



■ **V<sub>DDQ</sub> = 2.5V Interface specification**

**RECOMMENDED DC OPERATING CONDITIONS (Ta = 0 to 70°C)**

SYMBOL	PARAMETER	MIN	TYP.	MAX	UNIT
V <sub>DD</sub>	Power Supply Voltage	3.135	3.3	3.465	V
V <sub>DDQ</sub>	Output Buffer Power Supply Voltage	2.375	2.5	2.9	V
V <sub>IH</sub>	Input High Voltage for Address and Control pins	1.7	-	V <sub>DD</sub> + 0.3**	V
	Input High Voltage for I/O pins	1.7	-	V <sub>DDQ</sub> + 0.3***	
V <sub>IH1</sub>	Input High Voltage for MODE pin	V <sub>DD</sub> - 0.3	V <sub>DD</sub>	V <sub>DD</sub> + 0.3	V
V <sub>IL</sub>	Input Low Voltage	- 0.3 *	-	0.7	V
V <sub>IL1</sub>	Input Low Voltage for MODE and NU pins	- 0.3	0.0	0.3	V

\*: -0.7 V with a pulse width of 20% of t<sub>KC</sub>(min) (3 ns max)  
 \*\*: V<sub>DD</sub> + 0.7 V with a pulse width of 20% of t<sub>KC</sub>(min) (3 ns max)  
 \*\*\*: V<sub>DDQ</sub> + 0.7 V with a pulse width of 20% of t<sub>KC</sub>(min) (3 ns max)

NOTE: NU pin must be low or not connected.

**DC CHARACTERISTICS (Ta = 0 to 70°C, V<sub>DD</sub> = 3.3 V ± 5%, V<sub>DDQ</sub> = 2.375 V to 2.9 V)**

SYMBOL	PARAMETER	TEST CONDITIONS	MIN	TYP.	MAX	UNIT	
I <sub>IL</sub>	Input Leakage Current	V <sub>IN</sub> = 0 to V <sub>DD</sub>	- 1	-	1	μA	
I <sub>NU</sub>	Input Current (NU pin)	V <sub>IN</sub> = 0 V to 0.3 V	- 1	-	1	μA	
I <sub>LO</sub>	Output Leakage Current	Device Deselected or Output Deselected, V <sub>OUT</sub> = 0 to V <sub>DDQ</sub>	- 1	-	1	μA	
V <sub>OH</sub>	Output High Voltage	I <sub>OH</sub> = - 2 mA	1.7	-	-	V	
		I <sub>OH</sub> = - 100 μA	V <sub>DDQ</sub> - 0.2	-	-		
V <sub>OL</sub>	Output Low Voltage	I <sub>OL</sub> = 2 mA	-	-	0.7	V	
		I <sub>OL</sub> = 100 μA	-	-	0.2		
I <sub>DDO1</sub>	Operating Current	I <sub>OUT</sub> = 0 mA, all inputs = V <sub>DD</sub> - 0.2 V/0.2 V Clock ≥ t <sub>KC</sub> (min)	83MHz	-	-	240	mA
			75MHz	-	-	230	
I <sub>DDO2</sub>	Operating Current (idle)	Device Deselected I <sub>OUT</sub> = 0 mA, all inputs = V <sub>DD</sub> - 0.2 V/0.2 V Clock ≥ t <sub>KC</sub> (min)	83MHz	-	-	110	mA
			75MHz	-	-	100	
I <sub>DDS2</sub>	Standby Current (MOS level)	Clock = V <sub>SS</sub> , all inputs = V <sub>DD</sub> - 0.2 V or 0.2 V	-	-	10	mA	
I <sub>DDS3</sub>	Standby Current (Snooze Mode)	ZZ ≥ V <sub>DD</sub> - 0.2 V all inputs = V <sub>DD</sub> - 0.2 V or 0.2 V Clock ≥ t <sub>KC</sub> (min)	-	-	10	mA	
I <sub>DDS4</sub>	Standby Current (CKE Mode)	$\overline{\text{CKE}} \geq V_{IH}$ All inputs = V <sub>DD</sub> - 0.2 V or 0.2 V Clock ≥ t <sub>KC</sub> (min)	-	-	10	mA	

Note: Operating Current(I<sub>DDO1</sub>) is specified with 50% Read cycles and 50% Write cycles.

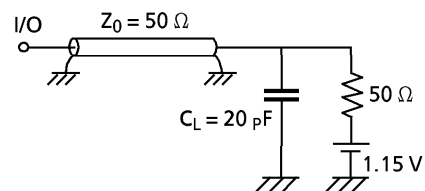
**AC CHARACTERISTICS** ( $T_a = 0$  to  $70^\circ\text{C}$ ,  $V_{DD} = 3.3\text{ V} \pm 5\%$ ,  $V_{DDQ} = 2.375\text{ V}$  to  $2.9\text{ V}$ )

SYMBOL	PARAMETER	TC55VL836FF-83		TC55VL836FF-75		UNIT
		MIN	MAX	MIN	MAX	
$t_{KC}$	CLK Cycle Time	12	–	13	–	ns
$t_{KH}$	CLK High Pulse Width	4	–	4	–	
$t_{KL}$	CLK Low Pulse Width	4	–	4	–	
$t_{KQV}$	CLK High to Output Valid	–	9	–	10	
$t_{KQX}$	CLK High to Output Invalid	3	–	3	–	
$t_{KQLZ}$	CLK High to Output Low-Z	4	–	4	–	
$t_{KQHZ}$	CLK High to Output High-Z	–	5	–	5	
$t_{GQV}$	$\overline{OE}$ Low to Output Valid	–	5	–	6	
$t_{GQLZ}$	$\overline{OE}$ Low to Output Low-Z	0	–	0	–	
$t_{GQHZ}$	$\overline{OE}$ High to Output High-Z	–	5	–	6	
$t_{AS}$	Address Setup Time from CLK	2	–	2	–	
$t_{DS}$	Data Setup Time from CLK	1.5	–	1.7	–	
$t_{WS}$	$\overline{WE}$ Setup Time from CLK	2	–	2	–	
$t_{CES}$	CE Setup Time from CLK	2	–	2	–	
$t_{ADVS}$	ADV Setup Time from CLK	2	–	2	–	
$t_{BWS}$	$\overline{BW}$ Setup Time from CLK	2	–	2	–	
$t_{CKES}$	$\overline{CKE}$ Setup Time from CLK	2	–	2	–	
$t_{AH}$	Address Hold Time from CLK	0.5	–	0.5	–	
$t_{DH}$	Data Hold Time from CLK	0.5	–	0.5	–	
$t_{WH}$	$\overline{WE}$ Hold Time from CLK	0.5	–	0.5	–	
$t_{CEH}$	CE Hold Time from CLK	0.5	–	0.5	–	
$t_{ADVH}$	ADV Hold Time from CLK	0.5	–	0.5	–	
$t_{BWH}$	$\overline{BW}$ Hold Time from CLK	0.5	–	0.5	–	
$t_{CKEH}$	$\overline{CKE}$ Hold Time from CLK	0.5	–	0.5	–	
$t_{ZZ}$	ZZ High to Input Ignored	0	$2t_{KC}$	0	$2t_{KC}$	
$t_{ZZR}$	ZZ Low to Input Sampled	0	$2t_{KC}$	0	$2t_{KC}$	
$t_{ZZHZ}$	ZZ High to Output High-Z	0	$2t_{KC}$	0	$2t_{KC}$	
$t_{ZZLZ}$	ZZ Low to Output Low-Z	0	–	0	–	

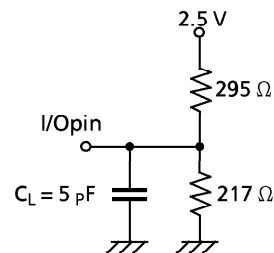
**AC TEST CONDITIONS**

Input Pulse Level	2.3 V/0.0 V
Input Pulse Rise and Fall Time	1 V/ns(20%/80%)
Input Timing Measurement Reference Level	1.15 V
Output Timing Measurement Reference Level	1.15 V
Output Load	As shown in Fig. 1 and Fig. 2

**Fig. 1 : AC test load**



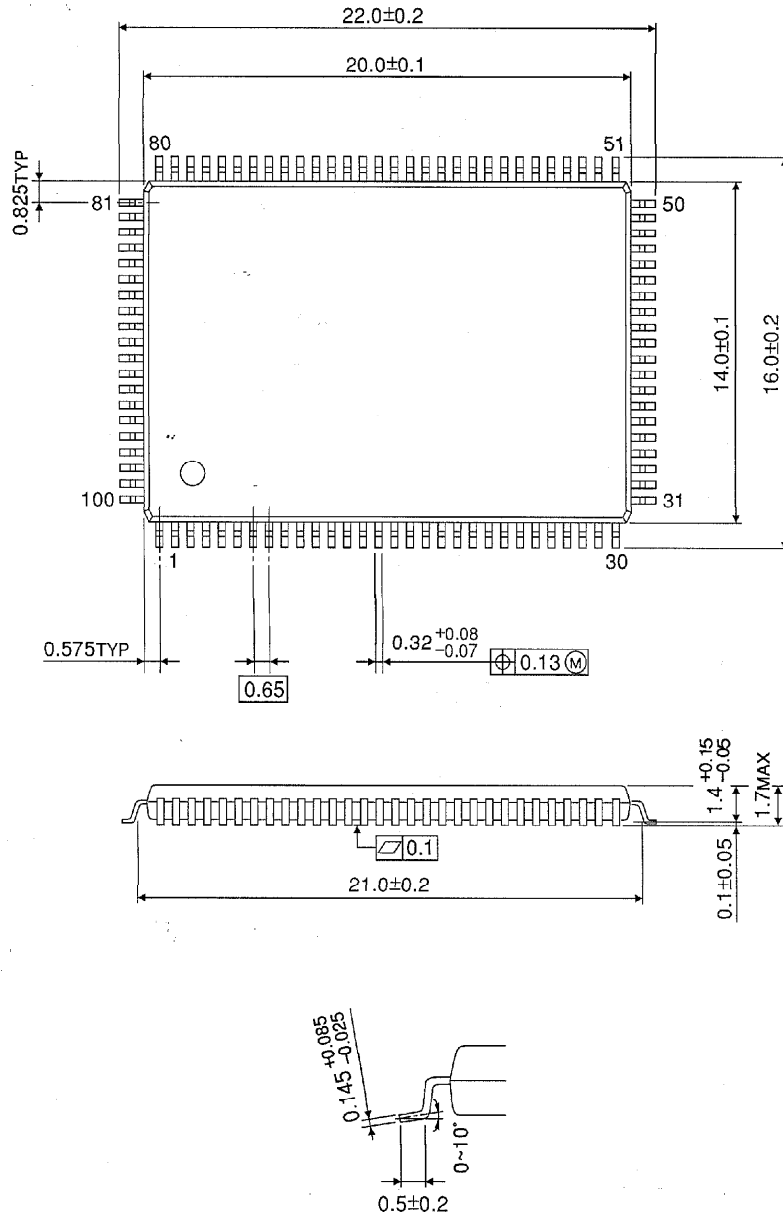
**Fig. 2 : AC test load (for Enable/Disable spec)**



**PACKAGE DIMENSIONS**

Plastic LQFP (LQFP100-P-1420-0.65K)

Unit: mm



Weight: 0.56 g (typ.)