

SURFACE MOUNTABLE FAST RECOVERY RECTIFIER DIODE

Description/Features

The 80EPF..S soft recovery rectifier series has been optimized for combined short reverse recovery time and low forward voltage drop.

The glass passivation ensures stable reliable operation in the most severe temperature and power cycling conditions.

Typical applications are both:

- output rectification and freewheeling in inverters, choppers and converters
- and input rectifications where severe restrictions on conducted EMI should be met.

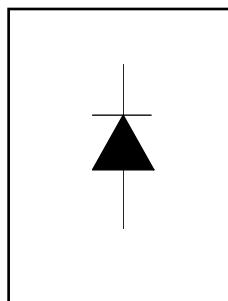

$$V_F < 1V @ 40A$$

$$t_{rr} = 70ns$$

$$V_{RRM} 200 \text{ to } 600V$$

Major Ratings and Characteristics

| Characteristics | 80EPF..S | Units |
|--|------------|------------------|
| $I_{F(AV)}$ Sinusoidal waveform | 80 | A |
| V_{RRM} | 200 to 600 | V |
| I_{FSM} | 830 | A |
| V_F @ 40 A, $T_J = 25^\circ\text{C}$ | 1 | V |
| t_{rr} @ 1A, -100A/ μs | 70 | ns |
| T_J | -40 to 125 | $^\circ\text{C}$ |

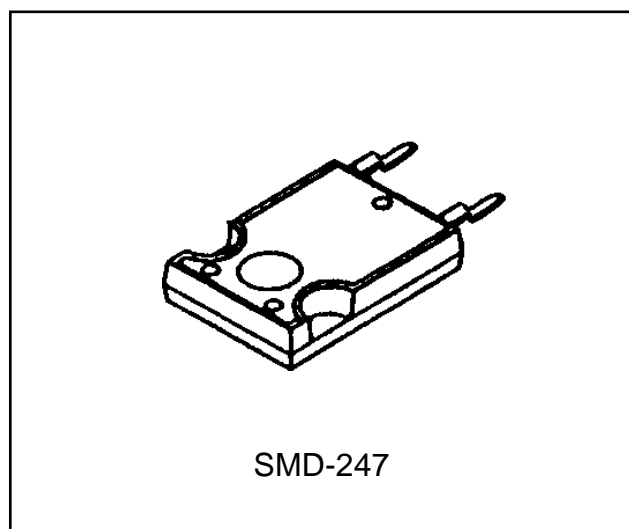

Voltage Ratings

| Part Number | V_{RRM} , maximum peak reverse voltage V | V_{RSM} , maximum non repetitive peak reverse voltage V | I_{RRM} 125°C mA |
|-------------|---|--|--------------------------|
| 80EPF02S | 200 | 300 | 5 |
| 80EPF04S | 400 | 500 | |
| 80EPF06S | 600 | 700 | |

Absolute Maximum Ratings

| Parameters | 80EPF..S | Units | Conditions |
|--|----------|---------------|---|
| $I_{F(AV)}$ Max. Average Forward Current | 80 | A | @ $T_C = 70^\circ C$, 180° conduction half sine wave |
| I_{FSM} Max. Peak One Cycle Non-Repetitive Surge Current | 700 | A | 10ms Sine pulse, rated V_{RRM} applied |
| | 830 | | 10ms Sine pulse, no voltage reapplied |
| I^2t Max. I^2t for fusing | 2450 | A^2s | 10ms Sine pulse, rated V_{RRM} applied |
| | 3465 | | 10ms Sine pulse, no voltage reapplied |
| $I^2\sqrt{t}$ Max. $I^2\sqrt{t}$ for fusing | 34650 | $A^2\sqrt{s}$ | t = 0.1 to 10ms, no voltage reapplied |

Electrical Specifications

| Parameters | 80EPF..S | Units | Conditions | |
|---------------------------------------|----------|-------|---------------------------|-------------------------------|
| V_{FM} Max. Forward Voltage Drop | 1.2 | V | @ 80A, $T_J = 25^\circ C$ | |
| r_t Forward slope resistance | 3.5 | mΩ | $T_J = 125^\circ C$ | |
| $V_{F(TO)}$ Threshold voltage | 0.85 | V | | |
| I_{RM} Max. Reverse Leakage Current | 0.1 | mA | $T_J = 25^\circ C$ | $V_R = \text{rated } V_{RRM}$ |
| | 5 | | $T_J = 125^\circ C$ | |

Recovery Characteristics

| Parameters | 80EPF..S | Units | Conditions | |
|-----------------------------------|----------|-------|------------------|--|
| t_{rr} Reverse Recovery Time | 180 | ns | $I_F @ 80A_{pk}$ | |
| I_{rr} Reverse Recovery Current | 3.4 | A | @ 25A/μs | |
| Q_{rr} Reverse Recovery Charge | 0.5 | μC | @ 25°C | |
| S Snap Factor | 0.5 | | | |

Thermal-Mechanical Specifications

| Parameters | | 80EPF..S | Units | Conditions |
|------------|--|------------|---------|--------------------------------------|
| T_J | Max. Junction Temperature Range | -40 to 125 | °C | |
| T_{stg} | Max. Storage Temperature Range | -40 to 125 | °C | |
| R_{thJC} | Max. Thermal Resistance Junction to Case | 0.35 | °C/W | DC operation |
| R_{thJA} | Max. Thermal Resistance Junction to Ambient | 40 | °C/W | |
| R_{thCS} | Typical Thermal Resistance, Case to Heatsink | 0.2 | °C/W | Mounting surface, smooth and greased |
| wt | Approximate Weight | 6 (0.21) | g (oz.) | |
| T | Mounting Torque | Min. | 6 (5) | Kg-cm (lbf-in) |
| | | Max. | 12 (10) | |
| Case Style | | SMD-247 | | |

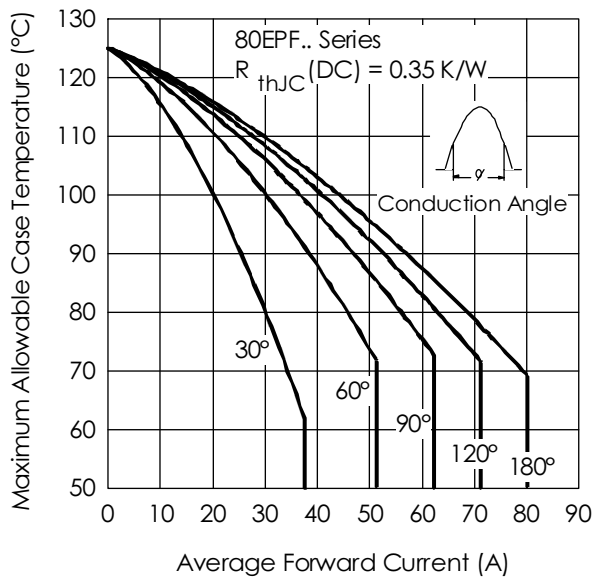

Fig. 1 - Current Rating Characteristics

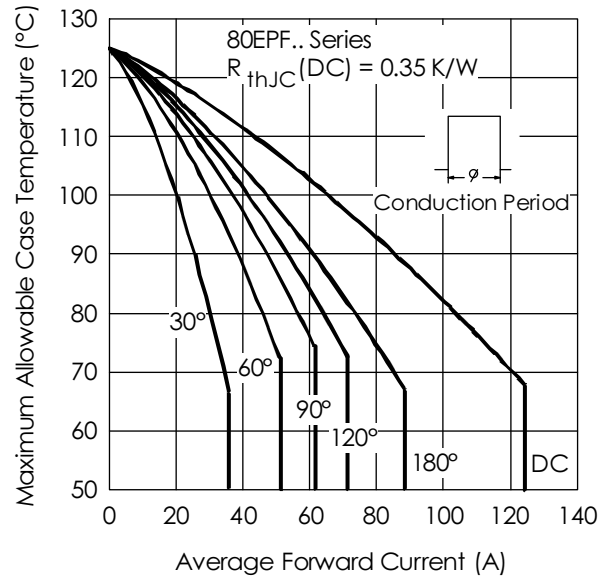

Fig. 2 - Current Rating Characteristics

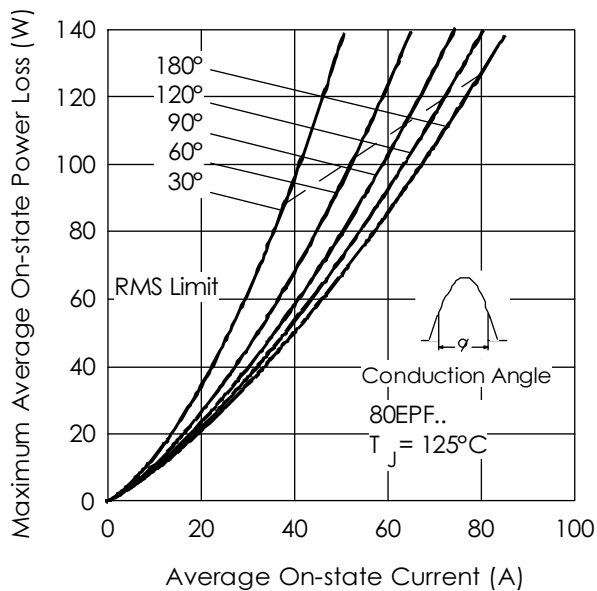

Fig. 3 - Forward Power Loss Characteristics

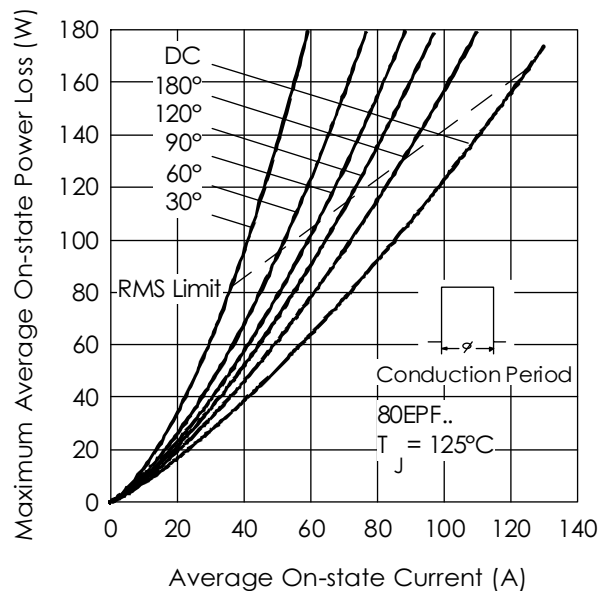

Fig. 4 - Forward Power Loss Characteristics

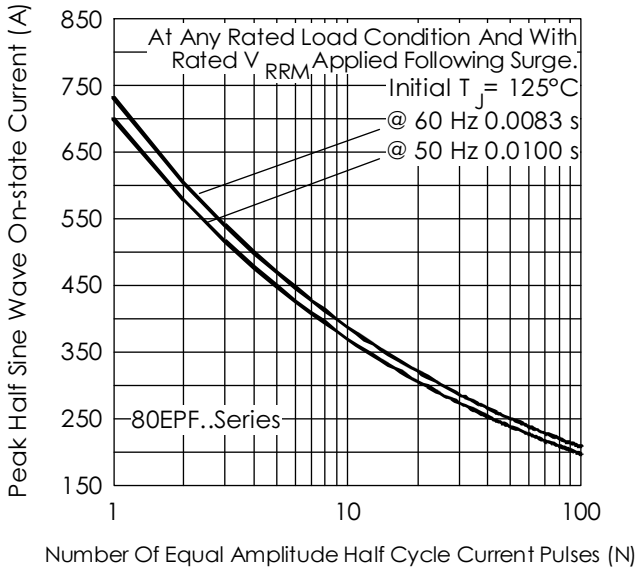

Fig. 5 - Maximum Non-Repetitive Surge Current

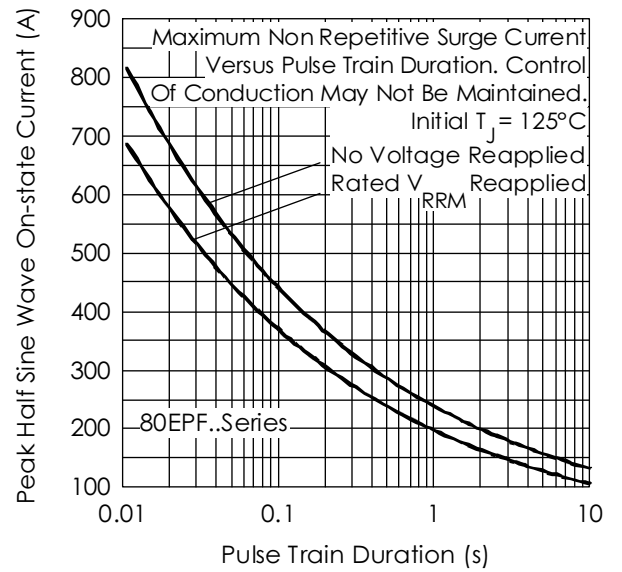

Fig. 6 - Maximum Non-Repetitive Surge Current

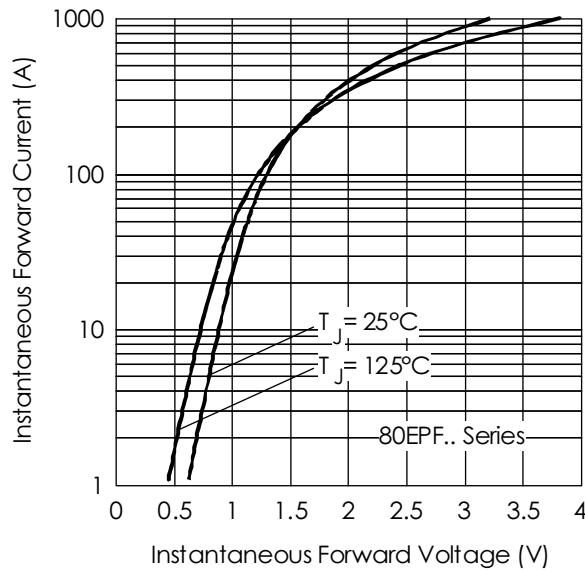

Fig. 7 - Forward Voltage Drop Characteristics

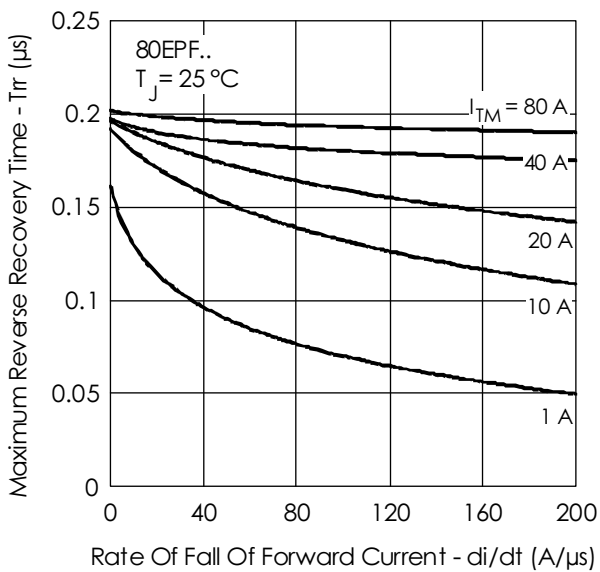

Fig. 8 - Recovery Time Characteristics, $T_J = 25^\circ\text{C}$

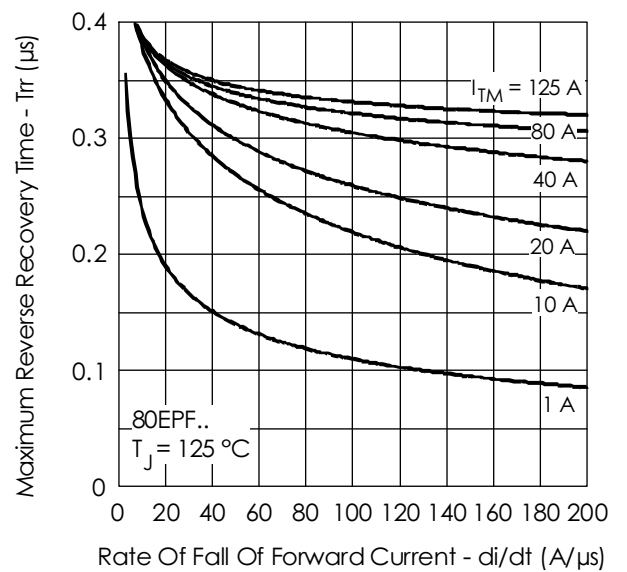

Fig. 9 - Recovery Time Characteristics, $T_J = 125^\circ\text{C}$

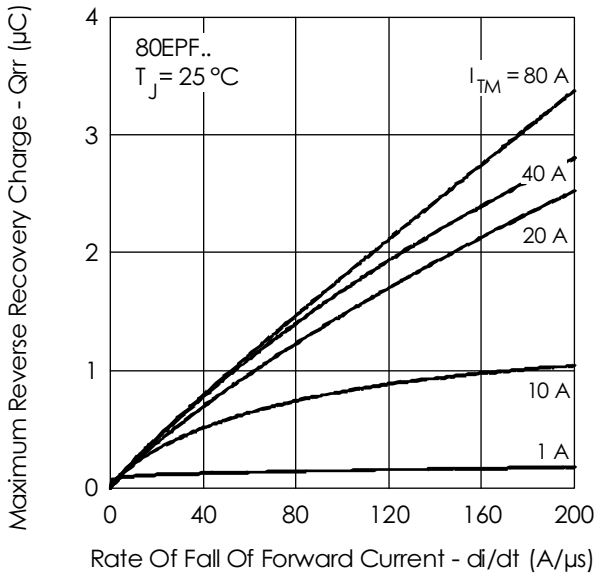

Fig. 10 - Recovery Charge Characteristics, $T_J = 25^\circ\text{C}$

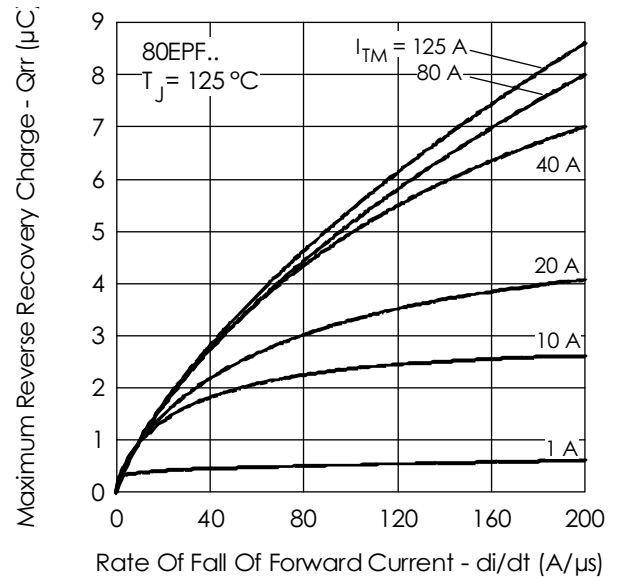

Fig. 11 - Recovery Charge Characteristics, $T_J = 125^\circ\text{C}$

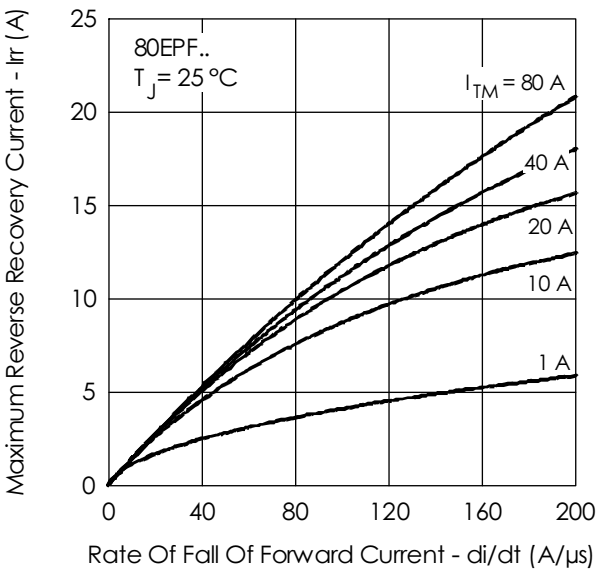

Fig. 12 - Recovery Current Characteristics, $T_J = 25^\circ\text{C}$

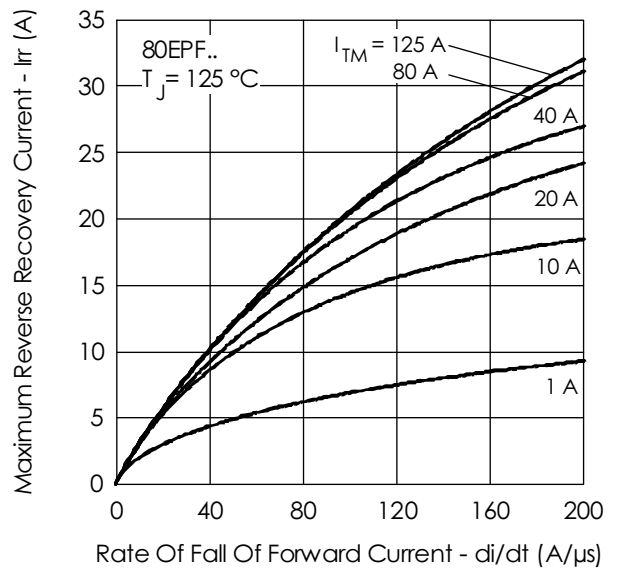

Fig. 13 - Recovery Current Characteristics, $T_J = 125^\circ\text{C}$

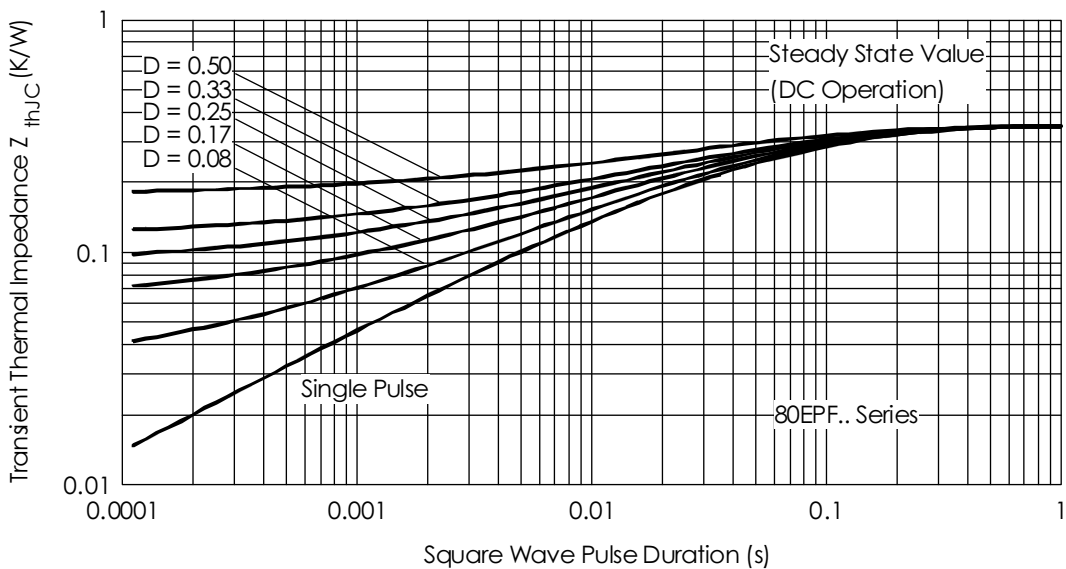
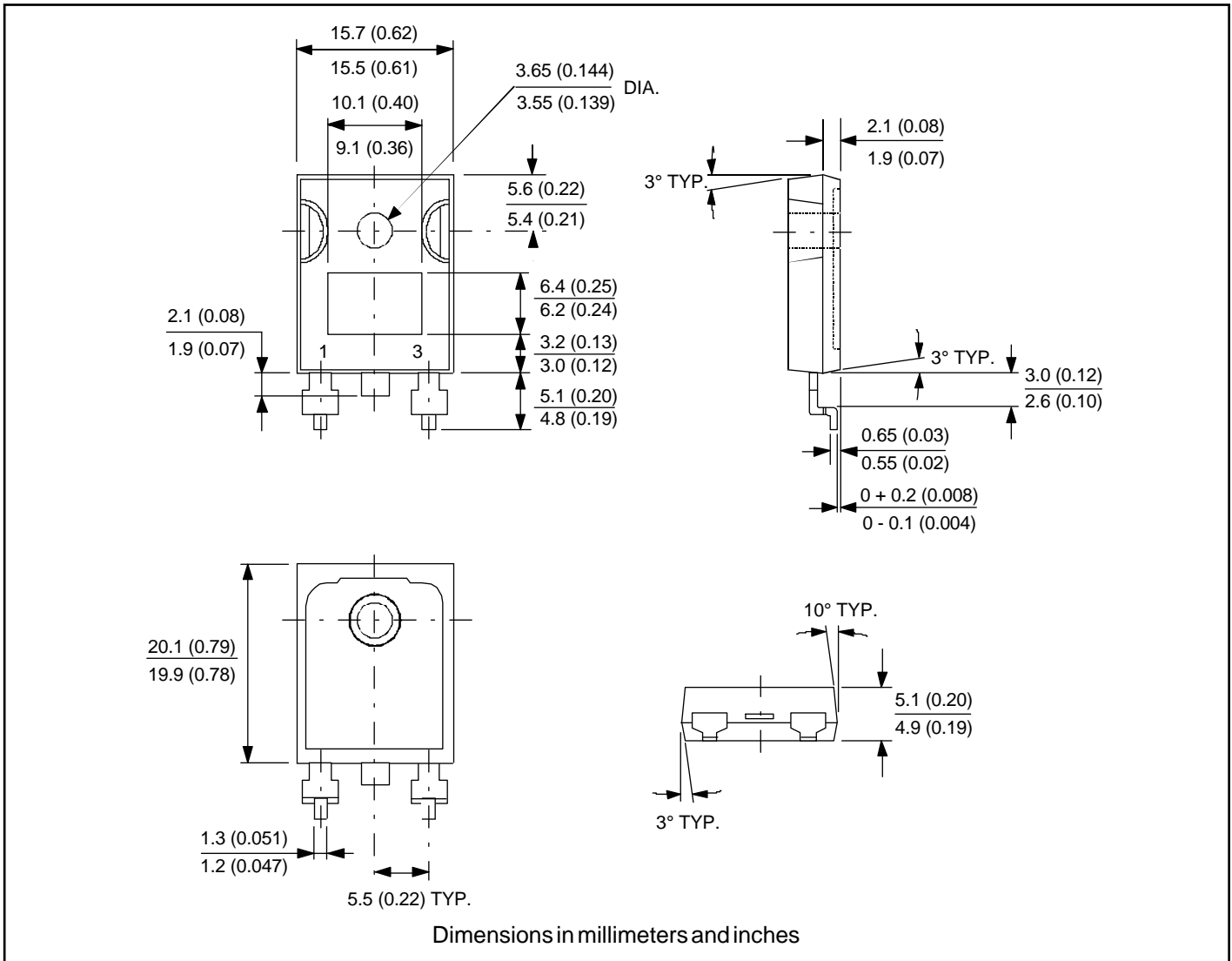

Fig. 14 - Thermal Impedance Z_{thJC} Characteristics

Outline Table



Ordering Information Table

Device Code

| | | | | | |
|-----------|----------|----------|----------|-----------|----------|
| 80 | E | P | F | 06 | S |
| ① | ② | ③ | ④ | ⑤ | ⑥ |

- 1** - Current Rating
- 2** - Circuit Configuration
E = Single Diode
- 3** - Package
P = TO-247AC (Modified)
- 4** - Type of Silicon
F = Fast Recovery
- 5** - Voltage code: Code x 100 = V_{RRM}
- 6** - S = TO-247AC (SMD-247) Version

| | |
|----|--------|
| 02 | = 200V |
| 04 | = 400V |
| 06 | = 600V |

BACK CATHODE 2
ANODE 1 ANODE 3