

6-353293-5 ✓ ACTIVE

AMP Mini CT

TE Internal #: 6-353293-5

Connector Assembly, Receptacle, Wire-to-Board, 15 Position, .06 in [1.5 mm] Centerline, Insulation Displacement (IDC), 1 Row, Blue, AMP Mini CT

[View on TE.com >](#)



Connectors > PCB Connectors > Wire-to-Board Connectors > Wire-to-Board Connector Assemblies & Housings

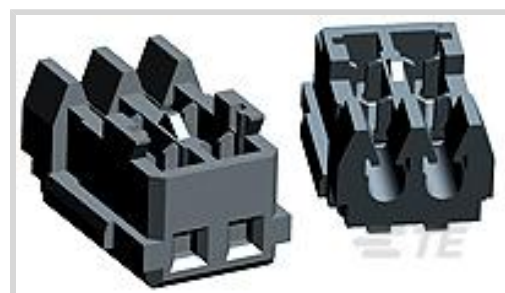

Connector Product Type: **Connector Assembly**

Connector & Housing Type: **Receptacle**

Connector System: **Wire-to-Board**

Number of Positions: **15**

Centerline (Pitch): **1.5 mm [.06 in]**

Features

Product Type Features

Connector Product Type	Connector Assembly
Connector & Housing Type	Receptacle
Connector System	Wire-to-Board
Sealable	No
Connector & Contact Terminates To	Wire & Cable

Configuration Features

Number of Positions	15
Number of Rows	1

Body Features

Primary Product Color	Blue
-----------------------	------

Contact Features

Contact Current Rating (Max)	2 A
------------------------------	-----

Termination Features

Termination Method to Wire & Cable	Insulation Displacement (IDC)
------------------------------------	-------------------------------

Mechanical Attachment

Mating Retention Type	Lock
Mating Retention	With
Connector Mounting Type	Cable Mount (Free-Hanging)



Housing Features

Centerline (Pitch)	1.5 mm[.06 in]
--------------------	----------------

Usage Conditions

Operating Temperature Range	-30 – 105 °C[-22 – 221 °F]
-----------------------------	----------------------------

Operation/Application

Circuit Application	Power & Signal
---------------------	----------------

Product Compliance

[For compliance documentation, visit the product page on TE.com>](#)

EU RoHS Directive 2011/65/EU	Compliant
EU ELV Directive 2000/53/EC	Compliant
China RoHS 2 Directive MIIT Order No 32, 2016	No Restricted Materials Above Threshold
EU REACH Regulation (EC) No. 1907/2006	Current ECHA Candidate List: JUNE 2023 (235) Candidate List Declared Against: JUNE 2023 (235) Does not contain REACH SVHC
Halogen Content	Not Low Halogen - contains Br or Cl > 900 ppm.
Solder Process Capability	Not applicable for solder process capability

Product Compliance Disclaimer

This information is provided based on reasonable inquiry of our suppliers and represents our current actual knowledge based on the information they provided. This information is subject to change. The part numbers that TE has identified as EU RoHS compliant have a maximum concentration of 0.1% by weight in homogenous materials for lead, hexavalent chromium, mercury, PBB, PBDE, DBP, BBP, DEHP, DIBP, and 0.01% for cadmium, or qualify for an exemption to these limits as defined in the Annexes of Directive 2011/65/EU (RoHS2). Finished electrical and electronic equipment products will be CE marked as required by Directive 2011/65/EU. Components may not be CE marked. Additionally, the part numbers that TE has identified as EU ELV compliant have a maximum concentration of 0.1% by weight in homogenous materials for lead, hexavalent chromium, and mercury, and 0.01% for cadmium, or qualify for an exemption to these limits as defined in the Annexes of Directive 2000/53/EC (ELV). Regarding the REACH Regulation, the information TE provides on SVHC in articles for this part number is based on the latest European Chemicals Agency (ECHA) 'Guidance on requirements for substances in articles' posted at this URL: <https://echa.europa.eu/guidance-documents/guidance-on-reach>

Compatible Parts



TE Part # 1-292230-5
1.5 MINI CT SGL V SMT W/BOSS 1



TE Part # 1-292207-5
MINI CT SGL DIP V 15P NAT

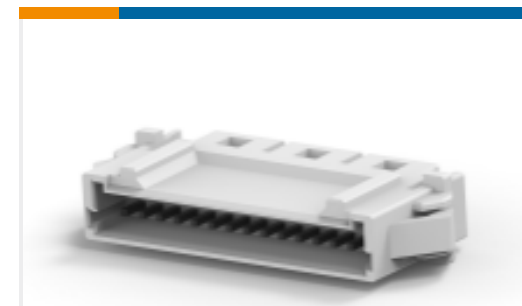

TE Part # 1-292215-5
MINI CT SGL RELAY 15P NAT



TE Part # CAT-AM7053-H342
MINI COMMON TERMINATION HEADERS

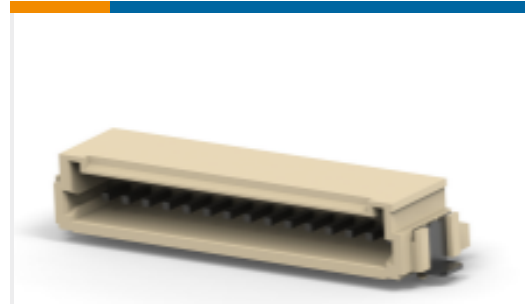

TE Part # 1-292227-5
1.5 MINI CT SGL H SMT W/BOSS 1

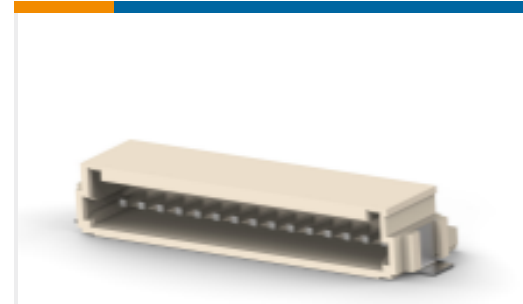

TE Part # 1-292228-5
1.5 MINI CT SGL H SMT W/O BOSS



TE Part # 1-292231-5
1.5 MINI CT SGL V SMT W/O BOSS



TE Part # 6-292207-5
MINI CT SGL DIP V 15P BLUE



TE Part # 6-292215-5
MINI CT SGL RELAY 15P BLUE



TE Part # 6-292227-5
1.5 MINI CT SGL H SMT W/BOSS 1



TE Part # 6-292228-5
1.5 MINI CT SGL H SMT W/O BOSS



TE Part # 6-292230-5
1.5 MINI CT SGL V SMT W/BOSS 1



TE Part # 6-292231-5
1.5 MINI CT SGL V SMT W/O BOSS



TE Part # 6-292272-5
S/R POST HDR ASSY V DIP AU-PL. 15P BLUE

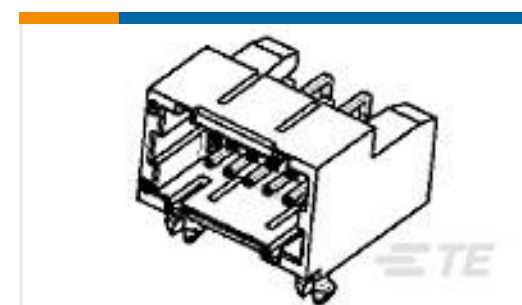

TE Part # 8-292262-0
DBL ROW (H) DIP TYPE WITH BOAR



TE Part # 8-353294-0
AMP MINI D/R HDR HSG 30P BLUE



TE Part # 937317-1
MIMI CT PISTOL TOOL

Also in the Series | **AMP Mini CT**



Connector Hardware(10)

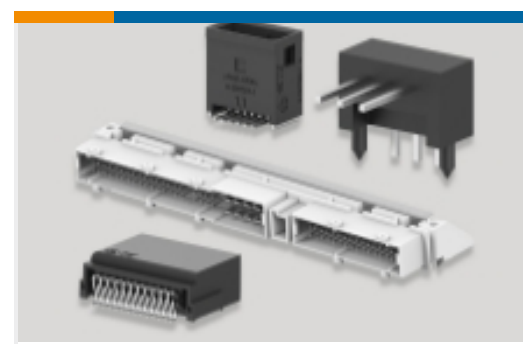

PCB Headers & Receptacles(332)

Wire-to-Board Connector Assemblies
& Housings(172)

Wire-to-Board Connector Contacts(4)

Customers Also Bought

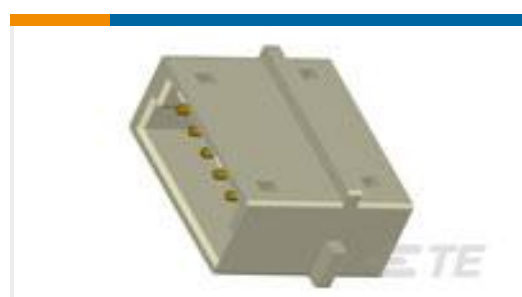
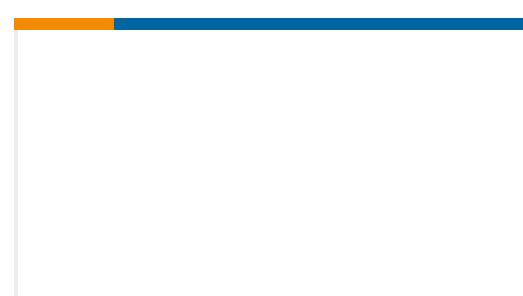
TE Part #6-173977-6
CT CONN MT REC ASSY 6P BLACKTE Part #292156-6
CT RELAY HDR ASSY FREE HANGINGTE Part #179939-1
POWER D/LOCK PLUG HSG 4P /6.5TE Part #292156-3
CT RELAY HDR ASSY FREE HANGINGTE Part #292156-2
CT RELAY HDR ASSY FREE HANGINGTE Part #353293-7
MINI CT MT REC ASSY 7P GRAYTE Part #2-353293-4
1.5MM CT MT REC ASSY 4P BLACKTE Part #292254-2
CT RELAY HDR ASSY 2P NATTE Part #8-292155-4
SGL HDR PANEL MOUNT ASSYTE Part #8-292155-6
SGL HDR PANEL MOUNT ASSY

Documents

CAD Files

Customer View Model

[ENG_CVM_CVM_6-353293-5_K.2d_dxf.zip](#)

English

3D PDF

3D

Customer View Model

[ENG_CVM_CVM_6-353293-5_K.3d_igs.zip](#)



English

Customer View Model

[ENG_CVM_CVM_6-353293-5_K.3d_stp.zip](#)

English

By downloading the CAD file I accept and agree to the [Terms and Conditions](#) of use.

Product Specifications

Application Specification

English

Product Environmental Compliance

Product Compliance

English

Product Compliance

English

Instruction Sheets

AIR MINI PRESS FOR AMP MINI CT CONNECTOR

Japanese

Instruction Sheet (non U.S.)

Japanese

Instruction Sheet for Mini CT DC Drawer Connector SF Type

Japanese

Instruction Sheet (non U.S.)

English

1.5mm Pitch Mini CT DC Drawer Connector SF Type

Japanese

Instruction Sheet (non U.S.)

Japanese

1.5mm Pitch Mini CT Hybrid Drawer Connector SF Type

Japanese

Instruction Sheet (non U.S.)

Japanese

1.5mm Pitch Mini CT Hybrid Drawer Connector Slim Type

Japanese

Instruction Sheet (non U.S.)

Japanese

Agency Approvals

UL

English