

The RF Line
NPN Silicon
High-Frequency Transistor

Designed for low noise, wide dynamic range front-end amplifiers and low-noise VCO's. Available in a surface-mountable plastic package. This Motorola small-signal plastic transistor offers superior quality and performance at low cost.

- High Gain-Bandwidth Product
 $f_T = 7.0 \text{ GHz (Typ) @ 30 mA}$
- Low Noise Figure
 $NF = 1.7 \text{ dB (Typ) @ 500 MHz}$
- High Gain
 $G_{NF} = 17 \text{ dB (Typ) @ 10 mA/500 MHz}$
- State-of-the-Art Technology
Fine Line Geometry
Ion-Implanted Arsenic Emitters
Gold Top Metallization and Wires
Silicon Nitride Passivation
- Available in tape and reel packaging options:
T1 suffix = 3,000 units per reel

MMBR911LT1

$I_C = 60 \text{ mA}$
LOW NOISE
HIGH-FREQUENCY
TRANSISTOR
NPN SILICON

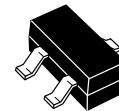

CASE 318-08, STYLE 6
SOT-23
LOW PROFILE

LIFETIME BUY

LAST SHIP: 17MAR01
LAST ORDER: 17SEP00

MAXIMUM RATINGS

Rating	Symbol	Value	Unit
Collector-Emitter Voltage	V_{CEO}	12	Vdc
Collector-Base Voltage	V_{CBO}	20	Vdc
Emitter-Base Voltage	V_{EBO}	2.0	Vdc
Collector Current — Continuous	I_C	60	mA
Power Dissipation @ $T_{case} = 75^\circ\text{C}$ (1) Derate linearly above $T_{case} = 75^\circ\text{C}$	$P_{D(max)}$	333 4.44	mW mW/°C
Storage Temperature	T_{stg}	-55 to +150	°C
Maximum Junction Temperature	T_{Jmax}	150	°C

THERMAL CHARACTERISTICS

Rating	Symbol	Value	Unit
Thermal Resistance, Junction to Case	$R_{\theta JC}$	225	°C/W

DEVICE MARKING

MMBR911LT1 = 7P

NOTE:

1. Case temperature measured on collector lead immediately adjacent to body of package.

ELECTRICAL CHARACTERISTICS ($T_C = 25^\circ\text{C}$ unless otherwise noted)

Characteristic	Symbol	Min	Typ	Max	Unit
----------------	--------	-----	-----	-----	------

OFF CHARACTERISTICS

Collector–Emitter Breakdown Voltage ($I_C = 1.0\text{ mA}$, $I_B = 0$)	$V_{(BR)CEO}$	12	—	—	Vdc
Collector–Base Breakdown Voltage ($I_C = 0.1\text{ mA}$, $I_E = 0$)	$V_{(BR)CBO}$	20	—	—	Vdc
Emitter–Base Breakdown Voltage ($I_E = 0.1\text{ mA}$, $I_C = 0$)	$V_{(BR)EBO}$	2.0	—	—	Vdc
Collector Cutoff Current ($V_{CB} = 15\text{ Vdc}$, $I_E = 0$)	I_{CBO}	—	—	50	nAdc

ON CHARACTERISTICS

DC Current Gain ($I_C = 30\text{ mAdc}$, $V_{CE} = 10\text{ Vdc}$)	h_{FE}	30	—	200	—
--	----------	----	---	-----	---

DYNAMIC CHARACTERISTICS

Collector–Base Capacitance ($V_{CB} = 10\text{ Vdc}$, $I_E = 0$, $f = 1.0\text{ MHz}$)	C_{cb}	—	—	1.0	pF
Current Gain–Bandwidth Product ($V_{CE} = 10\text{ Vdc}$, $I_C = 30\text{ mAdc}$, $f = 1.0\text{ GHz}$)	f_T	—	6.0	—	GHz

FUNCTIONAL TESTS

Gain @ Noise Figure ($I_C = 10\text{ mAdc}$, $V_{CE} = 10\text{ Vdc}$)	$f = 0.5\text{ GHz}$	G_{NF}	—	17	—	dB
	$f = 1.0\text{ GHz}$		—	11	—	
Noise Figure ($I_C = 10\text{ mAdc}$, $V_{CE} = 10\text{ Vdc}$)	$f = 0.5\text{ GHz}$	NF	—	2.0	—	dB
	$f = 1.0\text{ GHz}$		—	2.9	—	

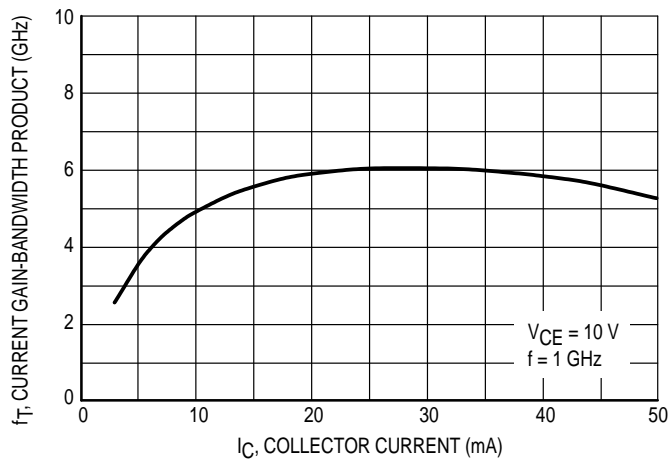

Figure 1. Current Gain–Bandwidth versus Collector Current @ 1.0 GHz

LIFETIME BUY

LAST ORDER: 17SEP00 LAST SHIP: 17MAR01

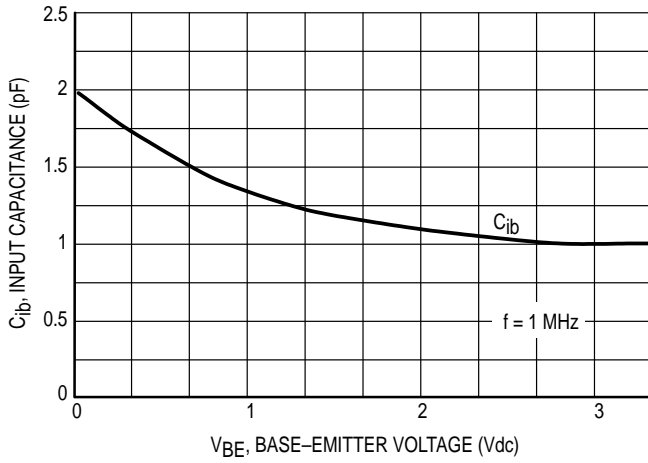

Figure 2. Input Capacitance versus Base-Emitter Voltage

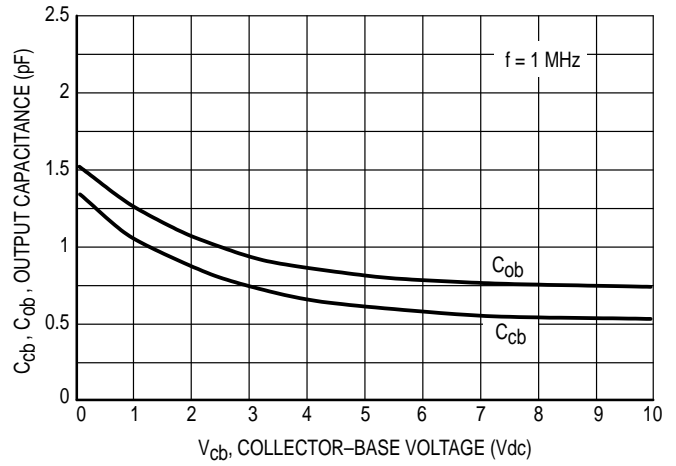

Figure 3. Output Capacitances versus Collector-Base Voltage

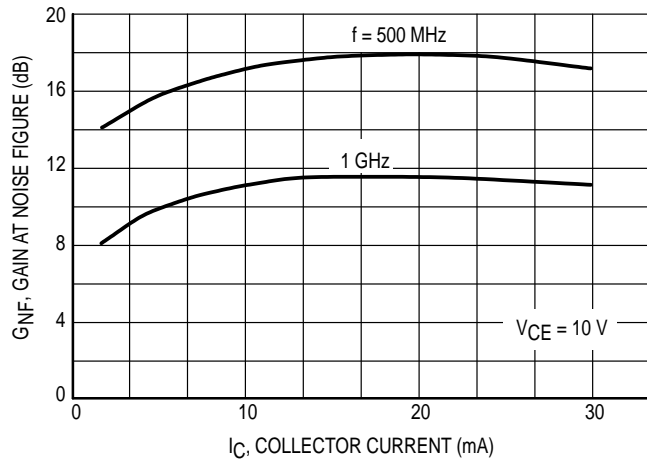

Figure 4. Gain at Noise Figure versus Collector Current

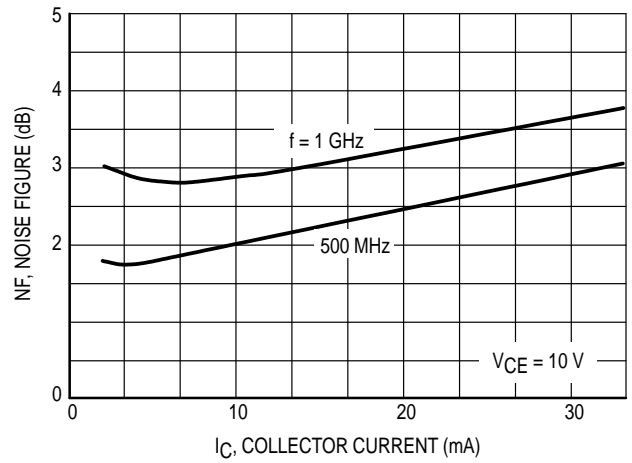

Figure 5. Noise Figure versus Collector Current

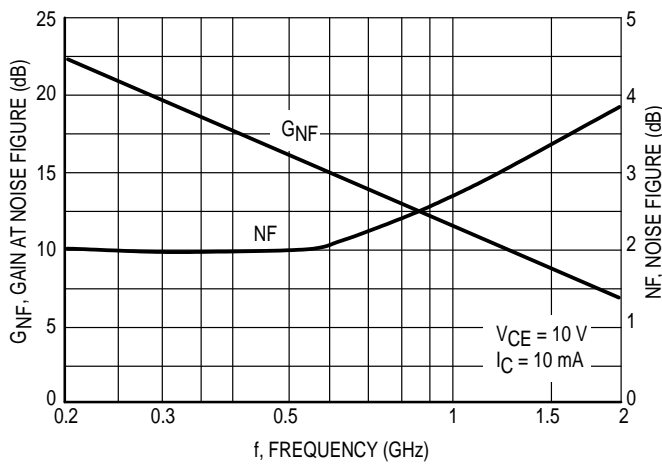

Figure 6. Gain at Noise Figure and Noise Figure versus Frequency

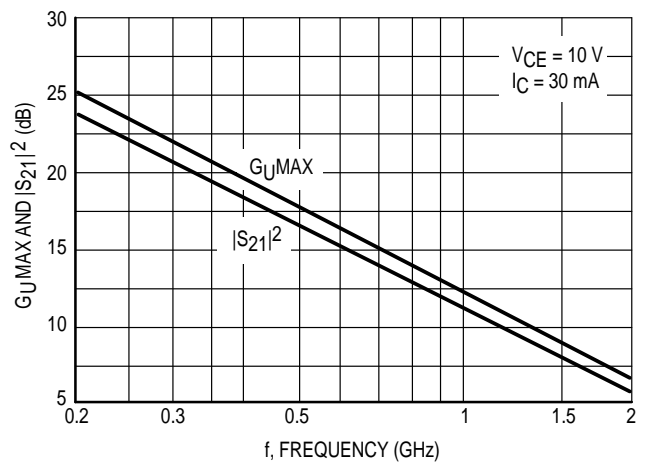

Figure 7. Maximum Unilateral Gain and Insertion Gain versus Frequency

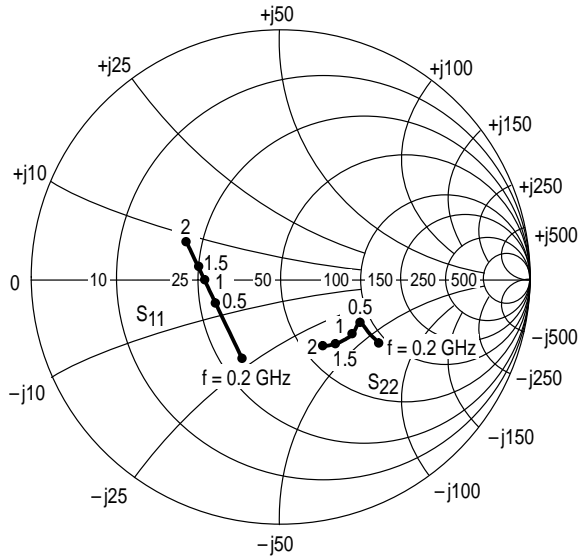

Figure 8. Input and Output Reflection Coefficients versus Frequency
VCE = 10 V, IC = 30 mA

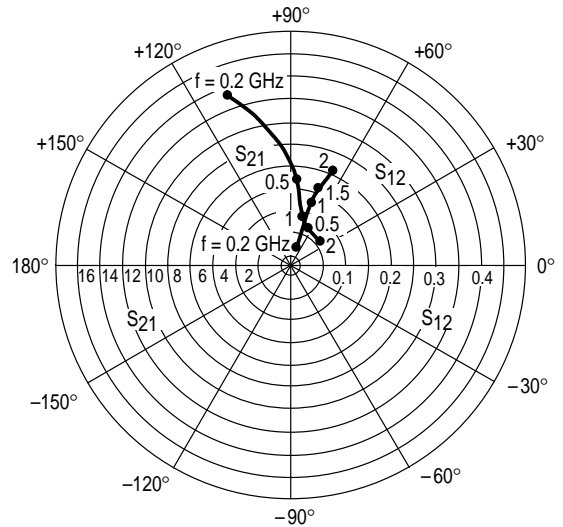
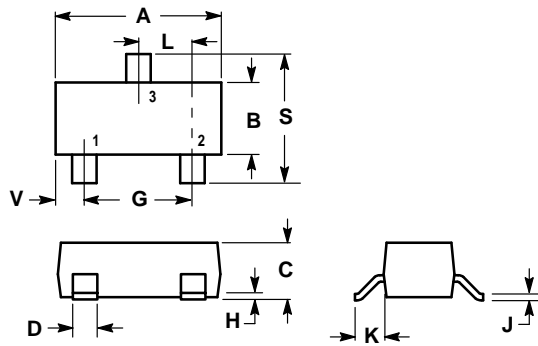

Figure 9. Forward and Reverse Transmission Coefficients versus Frequency
VCE = 10 V, IC = 30 mA

VCE (Volts)	IC (mA)	f (MHz)	S11		S21		S12		S22	
			S11	∠φ	S21	∠φ	S12	∠φ	S22	∠φ
10	2.0	200	0.82	-45	4.14	145	0.06	66	0.88	-16
		500	0.60	-96	3.23	112	0.09	49	0.71	-27
		1000	0.47	-149	2.16	85	0.11	49	0.62	-34
		1500	0.46	-179	1.59	71	0.13	55	0.58	-43
		2000	0.47	162	1.35	57	0.16	62	0.56	-51
	5.0	200	0.66	-63	8.63	134	0.05	64	0.75	-25
		500	0.43	-117	5.29	100	0.07	58	0.55	-31
		1000	0.37	-163	3.05	82	0.11	63	0.48	-36
		1500	0.38	176	2.17	70	0.15	65	0.45	-44
		2000	0.40	160	1.81	57	0.19	65	0.43	-51
	10	200	0.49	-83	12.70	124	0.04	65	0.62	-30
		500	0.33	-134	6.42	94	0.07	66	0.44	-32
		1000	0.32	-171	3.53	80	0.12	70	0.41	-36
		1500	0.35	173	2.46	69	0.16	69	0.38	-45
		2000	0.37	159	2.04	58	0.20	66	0.35	-52
20	200	0.36	-103	15.25	114	0.03	69	0.52	-32	
	500	0.28	-149	6.95	90	0.06	72	0.39	-30	
	1000	0.29	-176	3.73	78	0.12	73	0.37	-35	
	1500	0.33	172	2.60	68	0.17	71	0.34	-43	
	2000	0.36	158	2.14	58	0.21	67	0.32	-52	
30	200	0.32	-114	15.64	109	0.03	71	0.48	-29	
	500	0.27	-156	6.92	88	0.06	73	0.38	-27	
	1000	0.29	-178	3.71	78	0.12	74	0.37	-33	
	1500	0.34	170	2.58	68	0.16	72	0.34	-44	
	2000	0.37	156	2.13	57	0.21	68	0.32	-51	

Table 1. Common Emitter S-Parameters

PACKAGE DIMENSIONS



NOTES:

1. DIMENSIONING AND TOLERANCING PER ANSI Y14.5M, 1982.
2. CONTROLLING DIMENSION: INCH.
3. MAXIMUM LEAD THICKNESS INCLUDES LEAD FINISH THICKNESS. MINIMUM LEAD THICKNESS IS THE MINIMUM THICKNESS OF BASE MATERIAL.

DIM	INCHES		MILLIMETERS	
	MIN	MAX	MIN	MAX
A	0.1102	0.1197	2.80	3.04
B	0.0472	0.0551	1.20	1.40
C	0.0350	0.0440	0.89	1.11
D	0.0150	0.0200	0.37	0.50
G	0.0701	0.0807	1.78	2.04
H	0.0005	0.0040	0.013	0.100
J	0.0034	0.0070	0.085	0.177
K	0.0140	0.0285	0.35	0.69
L	0.0350	0.0401	0.89	1.02
S	0.0830	0.1039	2.10	2.64
V	0.0177	0.0236	0.45	0.60

STYLE 6:

- PIN 1. BASE
2. EMITTER
3. COLLECTOR

CASE 318-08
ISSUE AF

LIFETIME BUY

LAST ORDER: 17SEP00 LAST SHIP: 17MAR01

LIFETIME BUY

LAST ORDER: 17SEP00 LAST SHIP: 17MAR01

Motorola reserves the right to make changes without further notice to any products herein. Motorola makes no warranty, representation or guarantee regarding the suitability of its products for any particular purpose, nor does Motorola assume any liability arising out of the application or use of any product or circuit, and specifically disclaims any and all liability, including without limitation consequential or incidental damages. "Typical" parameters which may be provided in Motorola data sheets and/or specifications can and do vary in different applications and actual performance may vary over time. All operating parameters, including "Typicals" must be validated for each customer application by customer's technical experts. Motorola does not convey any license under its patent rights nor the rights of others. Motorola products are not designed, intended, or authorized for use as components in systems intended for surgical implant into the body, or other applications intended to support or sustain life, or for any other application in which the failure of the Motorola product could create a situation where personal injury or death may occur. Should Buyer purchase or use Motorola products for any such unintended or unauthorized application, Buyer shall indemnify and hold Motorola and its officers, employees, subsidiaries, affiliates, and distributors harmless against all claims, costs, damages, and expenses, and reasonable attorney fees arising out of, directly or indirectly, any claim of personal injury or death associated with such unintended or unauthorized use, even if such claim alleges that Motorola was negligent regarding the design or manufacture of the part. Motorola and  are registered trademarks of Motorola, Inc. Motorola, Inc. is an Equal Opportunity/Affirmative Action Employer.

Mfax is a trademark of Motorola, Inc.

How to reach us:

USA/EUROPE/Locations Not Listed: Motorola Literature Distribution;
P.O. Box 5405, Denver, Colorado 80217. 303-675-2140 or 1-800-441-2447

JAPAN: Nippon Motorola Ltd.: SPD, Strategic Planning Office, 4-32-1,
Nishi-Gotanda, Shinagawa-ku, Tokyo 141, Japan. 81-3-5487-8488

Mfax™: RMFAX0@email.sps.mot.com – TOUCHTONE 602-244-6609
– US & Canada ONLY 1-800-774-1848

ASIA/PACIFIC: Motorola Semiconductors H.K. Ltd.; 8B Tai Ping Industrial Park,
51 Ting Kok Road, Tai Po, N.T., Hong Kong. 852-26629298

INTERNET: <http://motorola.com/sps>



MMBR911LT1/D