

## LM3046 Transistor Array

 Check for Samples: [LM3046](#)

### FEATURES

- Two Matched Pairs of Transistors
  - $V_{BE}$  Matched  $\pm 5$  mV
  - Input Offset Current 2  $\mu$ A Max at  $I_C = 1$  mA
- Five General Purpose Monolithic transistors
- Operation from DC to 120 MHz
- Wide Operating Current Range
- Low Noise Figure: 3.2 dB typ at 1 kHz

### APPLICATIONS

- General Use in All Types of Signal Processing Systems Operating Anywhere in the Frequency Range from DC to VHF
- Custom Designed Differential Amplifiers
- Temperature Compensated Amplifiers

### DESCRIPTION

The LM3046 consists of five general purpose silicon NPN transistors on a common monolithic substrate. Two of the transistors are internally connected to form a differentially-connected pair. The transistors are well suited to a wide variety of applications in low power system in the DC through VHF range. They may be used as discrete transistors in conventional circuits however, in addition, they provide the very significant inherent integrated circuit advantages of close electrical and thermal matching. The LM3046 is supplied in a 14-lead SOIC package.

### Schematic and Connection Diagram

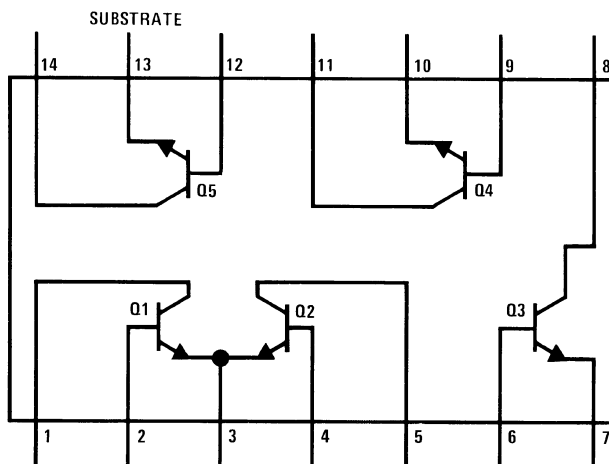

**Figure 1. SOIC Package  
Top View  
See Package Number D (R-PDSO-G14)**



These devices have limited built-in ESD protection. The leads should be shorted together or the device placed in conductive foam during storage or handling to prevent electrostatic damage to the MOS gates.



Please be aware that an important notice concerning availability, standard warranty, and use in critical applications of Texas Instruments semiconductor products and disclaimers thereto appears at the end of this data sheet.

All trademarks are the property of their respective owners.

**Absolute Maximum Ratings<sup>(1)(2)(3)</sup>**

		Each Transistor	Total Package	Units
Power Dissipation	$T_A = 25^\circ\text{C}$	300	750	mW
	$T_A = 25^\circ\text{C}$ to $55^\circ\text{C}$	300	750	
	$T_A > 55^\circ\text{C}$	Derate at 6.67		mW/ $^\circ\text{C}$
	$T_A = 25^\circ\text{C}$ to $75^\circ\text{C}$			mW
	$T_A > 75^\circ\text{C}$			mW/ $^\circ\text{C}$
Collector to Emitter Voltage, $V_{CEO}$		15		V
Collector to Base Voltage, $V_{CBO}$		20		
Collector to Substrate Voltage, $V_{CISO}^{(4)}$		20		
Emitter to Base Voltage, $V_{EBO}$		5		
Collector Current, $I_C$		50		mA
Operating Temperature Range		-40 $^\circ\text{C}$ to +85 $^\circ\text{C}$		
Storage Temperature Range		-65 $^\circ\text{C}$ to +85 $^\circ\text{C}$		
Soldering Information	Dual-In-Line Package Soldering (10 Sec.)	260 $^\circ\text{C}$		
	SOIC Package			
	Vapor Phase (60 Seconds)	215 $^\circ\text{C}$		
	Infrared (15 Seconds)	220 $^\circ\text{C}$		

- (1) "Absolute Maximum Ratings" indicate limits beyond which damage to the device may occur. Operating Ratings indicate conditions for which the device is functional, but do not guarantee specific performance limits.
- (2) See AN-450 "Surface Mounting Methods and Their Effect on Product Reliability" for other methods of soldering surface mount devices.
- (3) If Military/Aerospace specified devices are required, please contact the Texas Instruments Sales Office/ Distributors for availability and specifications.
- (4) The collector of each transistor is isolated from the substrate by an integral diode. The substrate (terminal 13) must be connected to the most negative point in the external circuit to maintain isolation between transistors and to provide for normal transistor action.

**Electrical Characteristics<sup>(1)</sup>**

Parameter	Conditions	Min	Typ	Max	Units
Collector to Base Breakdown Voltage ( $V_{(BR)CBO}$ )	$I_C = 10 \mu A, I_E = 0$	20	60		V
Collector to Emitter Breakdown Voltage ( $V_{(BR)CEO}$ )	$I_C = 1 mA, I_B = 0$	15	24		V
Collector to Substrate Breakdown Voltage ( $V_{(BR)CIO}$ )	$I_C = 10 \mu A, I_{CI} = 0$	20	60		V
Emitter to Base Breakdown Voltage ( $V_{(BR)EBO}$ )	$I_E = 10 \mu A, I_C = 0$	5	7		V
Collector Cutoff Current ( $I_{CBO}$ )	$V_{CB} = 10V, I_E = 0$		0.002	40	nA
Collector Cutoff Current ( $I_{CEO}$ )	$V_{CE} = 10V, I_B = 0$			0.5	$\mu A$
Static Forward Current Transfer Ratio (Static Beta) ( $h_{FE}$ )	$V_{CE} = 3V, I_C = 10 mA$		100		
	$I_C = 1 mA$	40	100		
	$I_C = 10 \mu A$		54		
Input Offset Current for Matched Pair $Q_1$ and $Q_2$ $ I_{O1} - I_{O2} $	$V_{CE} = 3V, I_C = 1 mA$		0.3	2	$\mu A$
Base to Emitter Voltage ( $V_{BE}$ )	$V_{CE} = 3V, I_E = 1 mA$		0.715		V
	$I_E = 10 mA$		0.800		
Magnitude of Input Offset Voltage for Differential Pair $ V_{BE1} - V_{BE2} $	$V_{CE} = 3V, I_C = 1 mA$		0.45	5	mV
Magnitude of Input Offset Voltage for Isolated Transistors $ V_{BE3} - V_{BE4} ,  V_{BE4} - V_{BE5} ,  V_{BE5} - V_{BE3} $	$V_{CE} = 3V, I_C = 1 mA$		0.45	5	mV
Temperature Coefficient of Base to Emitter Voltage $\left(\frac{\Delta V_{BE}}{\Delta T}\right)$ (1)	$V_{CE} = 3V, I_C = 1 mA$		-1.9		mV/°C
Collector to Emitter Saturation Voltage ( $V_{CE(SAT)}$ )	$I_B = 1 mA, I_C = 10 mA$		0.23		V
Temperature Coefficient of Input Offset Voltage $\left(\frac{\Delta V_{10}}{\Delta T}\right)$ (2)	$V_{CE} = 3V, I_C = 1 mA$		1.1		$\mu V/°C$
Low Frequency Noise Figure (NF)	$f = 1 kHz, V_{CE} = 3V, I_C = 100 \mu A, R_S = 1 k\Omega$		3.25		dB
<b>LOW FREQUENCY, SMALL SIGNAL EQUIVALENT CIRCUIT CHARACTERISTICS</b>					
Forward Current Transfer Ratio ( $h_{fe}$ )	$f = 1 kHz, V_{CE} = 3V, I_C = 1 mA$		110		
Short Circuit Input Impedance ( $h_{ie}$ )			3.5		k $\Omega$
Open Circuit Output Impedance ( $h_{oe}$ )			15.6		$\mu mho$
Open Circuit Reverse Voltage Transfer Ratio ( $h_{re}$ )			$1.8 \times 10^{-4}$		
<b>ADMITTANCE CHARACTERISTICS</b>					
Forward Transfer Admittance ( $Y_{fe}$ )	$f = 1 MHz, V_{CE} = 3V, I_C = 1 mA$		$31 - j 1.5$		
Input Admittance ( $Y_{ie}$ )			$0.3 + j 0.04$		
Output Admittance ( $Y_{oe}$ )			$0.001 + j 0.03$		
Reverse Transfer Admittance ( $Y_{re}$ )			See Figure 16		
Gain Bandwidth Product ( $f_T$ )	$V_{CE} = 3V, I_C = 3 mA$	300	550		
Emitter to Base Capacitance ( $C_{EB}$ )	$V_{EB} = 3V, I_E = 0$		0.6		pF
Collector to Base Capacitance ( $C_{CB}$ )	$V_{CB} = 3V, I_C = 0$		0.58		pF
Collector to Substrate Capacitance ( $C_{CI}$ )	$V_{CS} = 3V, I_C = 0$		2.8		pF

(1) ( $T_A = 25^\circ C$  unless otherwise specified)

### Typical Performance Characteristics

Typical Collector To Base Cutoff Current vs Ambient Temperature for Each Transistor

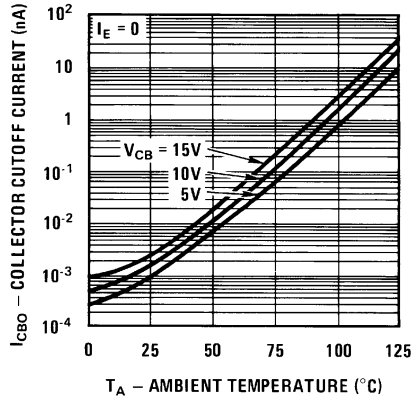

Figure 2.

Typical Collector To Emitter Cutoff Current vs Ambient Temperature for Each Transistor

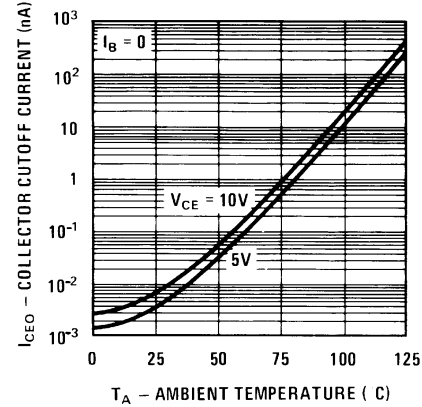

Figure 3.

Typical Static Forward Current-Transfer Ratio and Beta Ratio for Transistors Q<sub>1</sub> and Q<sub>2</sub> vs Emitter Current

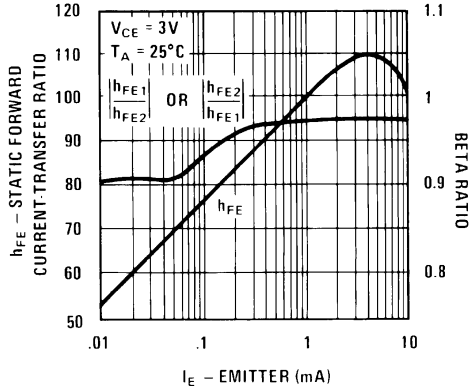

Figure 4.

Typical Input Offset Current for Matched Transistor Pair Q<sub>1</sub> Q<sub>2</sub> vs Collector Current

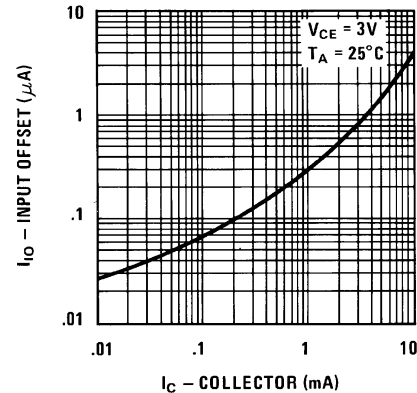

Figure 5.

Typical Static Base To Emitter Voltage Characteristic and Input Offset Voltage for Differential Pair and Paired Isolated Transistors vs Emitter Current

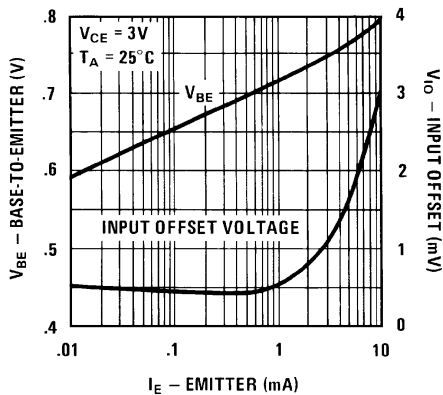

Figure 6.

Typical Base To Emitter Voltage Characteristic for Each Transistor vs Ambient Temperature

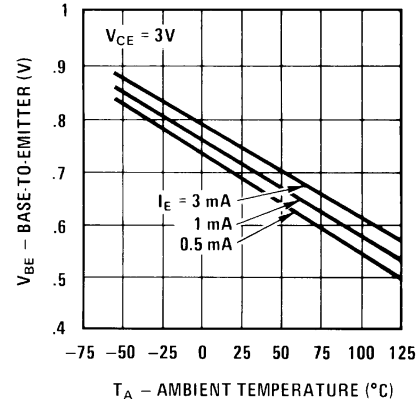

Figure 7.

Typical Performance Characteristics (continued)

Typical Input Offset Voltage Characteristics for Differential Pair and Paired Isolated Transistors vs Ambient Temperature

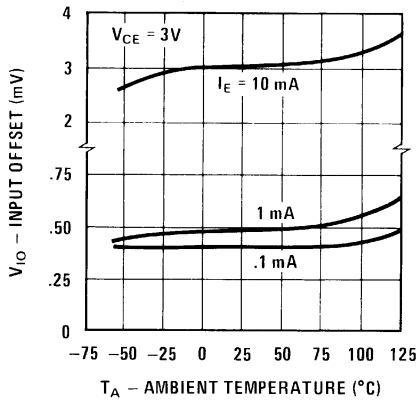

Figure 8.

Typical Noise Figure vs Collector Current

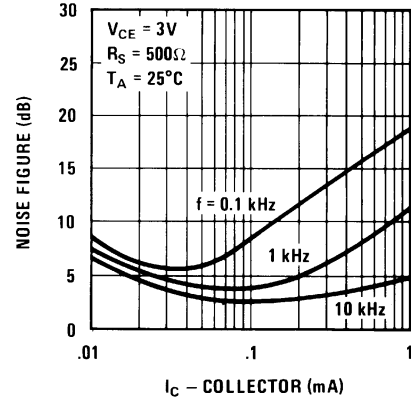

Figure 9.

Typical Noise Figure vs Collector Current

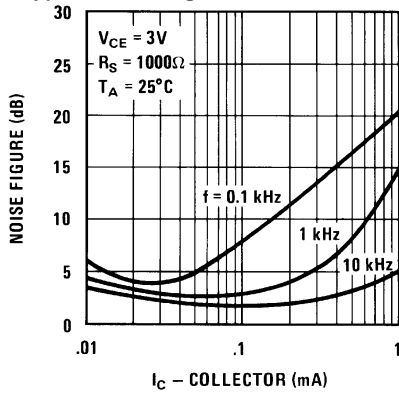

Figure 10.

Typical Noise Figure vs Collector Current

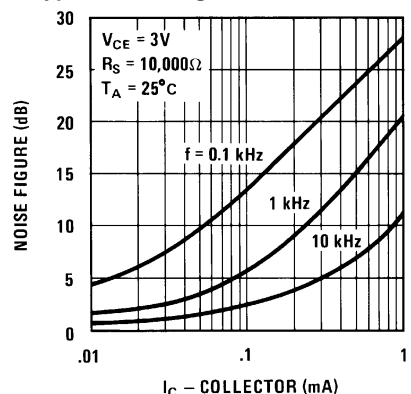

Figure 11.

Typical Normalized Forward Current Transfer Ratio, Short Circuit Input Impedance, Open Circuit Output Impedance, and Open Circuit Reverse Transfer Ratio vs Collector Current

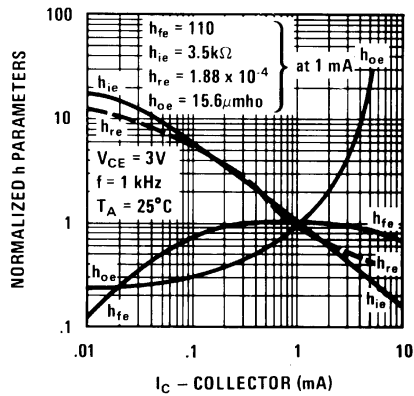

Figure 12.

Typical Forward Transfer Admittance vs Frequency

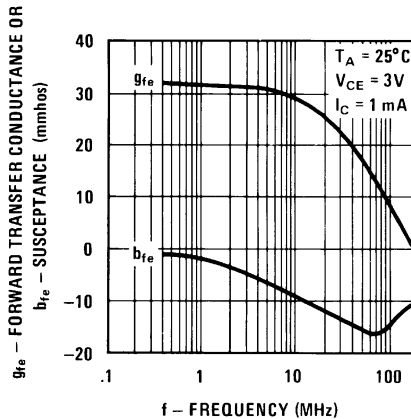

Figure 13.

**Typical Performance Characteristics (continued)**

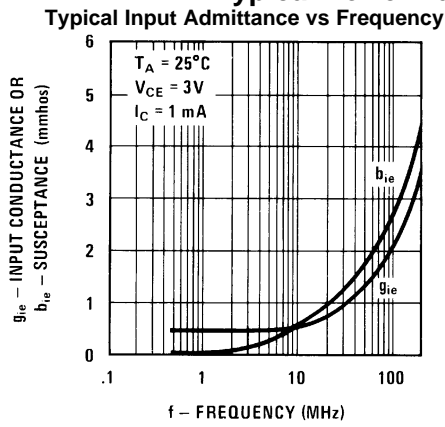

Figure 14.

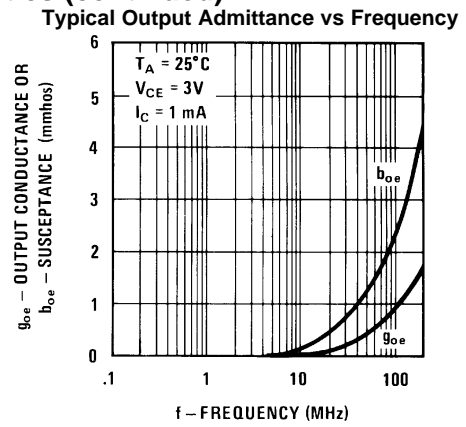

Figure 15.

**Typical Reverse Transfer Admittance vs Frequency**

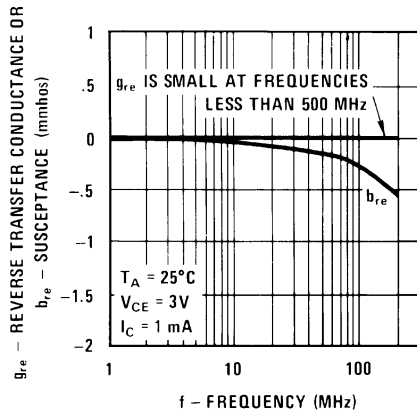

Figure 16.

**Typical Gain-Bandwidth Product vs Collector Current**

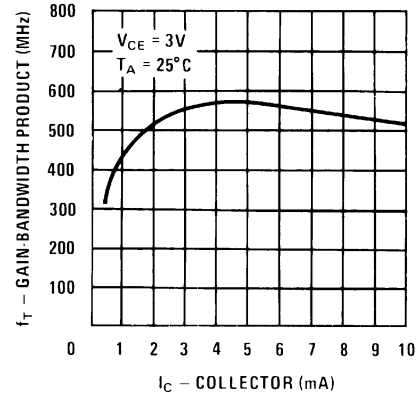

Figure 17.

---

**REVISION HISTORY**

<b>Changes from Revision A (March 2013) to Revision B</b>	<b>Page</b>
• Changed layout of National Data Sheet to TI format .....	<a href="#">4</a>

---

**PACKAGING INFORMATION**

Orderable Device	Status (1)	Package Type	Package Drawing	Pins	Package Qty	Eco Plan (2)	Lead/Ball Finish (6)	MSL Peak Temp (3)	Op Temp (°C)	Device Marking (4/5)	Samples
LM3046M	NRND	SOIC	D	14	55	TBD	Call TI	Call TI	-40 to 85	LM3046M	
LM3046M/NOPB	ACTIVE	SOIC	D	14	55	Green (RoHS & no Sb/Br)	CU SN	Level-1-260C-UNLIM	-40 to 85	LM3046M	<b>Samples</b>
LM3046MX	NRND	SOIC	D	14		TBD	Call TI	Call TI	-40 to 85	LM3046M	
LM3046MX/NOPB	ACTIVE	SOIC	D	14	2500	Green (RoHS & no Sb/Br)	CU SN	Level-1-260C-UNLIM	-40 to 85	LM3046M	<b>Samples</b>

(1) The marketing status values are defined as follows:

**ACTIVE:** Product device recommended for new designs.

**LIFEBUY:** TI has announced that the device will be discontinued, and a lifetime-buy period is in effect.

**NRND:** Not recommended for new designs. Device is in production to support existing customers, but TI does not recommend using this part in a new design.

**PREVIEW:** Device has been announced but is not in production. Samples may or may not be available.

**OBSELETE:** TI has discontinued the production of the device.

(2) Eco Plan - The planned eco-friendly classification: Pb-Free (RoHS), Pb-Free (RoHS Exempt), or Green (RoHS & no Sb/Br) - please check <http://www.ti.com/productcontent> for the latest availability information and additional product content details.

**TBD:** The Pb-Free/Green conversion plan has not been defined.

**Pb-Free (RoHS):** TI's terms "Lead-Free" or "Pb-Free" mean semiconductor products that are compatible with the current RoHS requirements for all 6 substances, including the requirement that lead not exceed 0.1% by weight in homogeneous materials. Where designed to be soldered at high temperatures, TI Pb-Free products are suitable for use in specified lead-free processes.

**Pb-Free (RoHS Exempt):** This component has a RoHS exemption for either 1) lead-based flip-chip solder bumps used between the die and package, or 2) lead-based die adhesive used between the die and leadframe. The component is otherwise considered Pb-Free (RoHS compatible) as defined above.

**Green (RoHS & no Sb/Br):** TI defines "Green" to mean Pb-Free (RoHS compatible), and free of Bromine (Br) and Antimony (Sb) based flame retardants (Br or Sb do not exceed 0.1% by weight in homogeneous material)

(3) MSL, Peak Temp. - The Moisture Sensitivity Level rating according to the JEDEC industry standard classifications, and peak solder temperature.

(4) There may be additional marking, which relates to the logo, the lot trace code information, or the environmental category on the device.

(5) Multiple Device Markings will be inside parentheses. Only one Device Marking contained in parentheses and separated by a "~" will appear on a device. If a line is indented then it is a continuation of the previous line and the two combined represent the entire Device Marking for that device.

(6) Lead/Ball Finish - Orderable Devices may have multiple material finish options. Finish options are separated by a vertical ruled line. Lead/Ball Finish values may wrap to two lines if the finish value exceeds the maximum column width.

**Important Information and Disclaimer:** The information provided on this page represents TI's knowledge and belief as of the date that it is provided. TI bases its knowledge and belief on information provided by third parties, and makes no representation or warranty as to the accuracy of such information. Efforts are underway to better integrate information from third parties. TI has taken and



continues to take reasonable steps to provide representative and accurate information but may not have conducted destructive testing or chemical analysis on incoming materials and chemicals. TI and TI suppliers consider certain information to be proprietary, and thus CAS numbers and other limited information may not be available for release.

In no event shall TI's liability arising out of such information exceed the total purchase price of the TI part(s) at issue in this document sold by TI to Customer on an annual basis.

## TAPE AND REEL INFORMATION



### QUADRANT ASSIGNMENTS FOR PIN 1 ORIENTATION IN TAPE



\*All dimensions are nominal

Device	Package Type	Package Drawing	Pins	SPQ	Reel Diameter (mm)	Reel Width W1 (mm)	A0 (mm)	B0 (mm)	K0 (mm)	P1 (mm)	W (mm)	Pin1 Quadrant
LM3046MX/NOPB	SOIC	D	14	2500	330.0	16.4	6.5	9.35	2.3	8.0	16.0	Q1

**TAPE AND REEL BOX DIMENSIONS**



\*All dimensions are nominal

Device	Package Type	Package Drawing	Pins	SPQ	Length (mm)	Width (mm)	Height (mm)
LM3046MX/NOPB	SOIC	D	14	2500	367.0	367.0	35.0

D (R-PDSO-G14)

PLASTIC SMALL OUTLINE

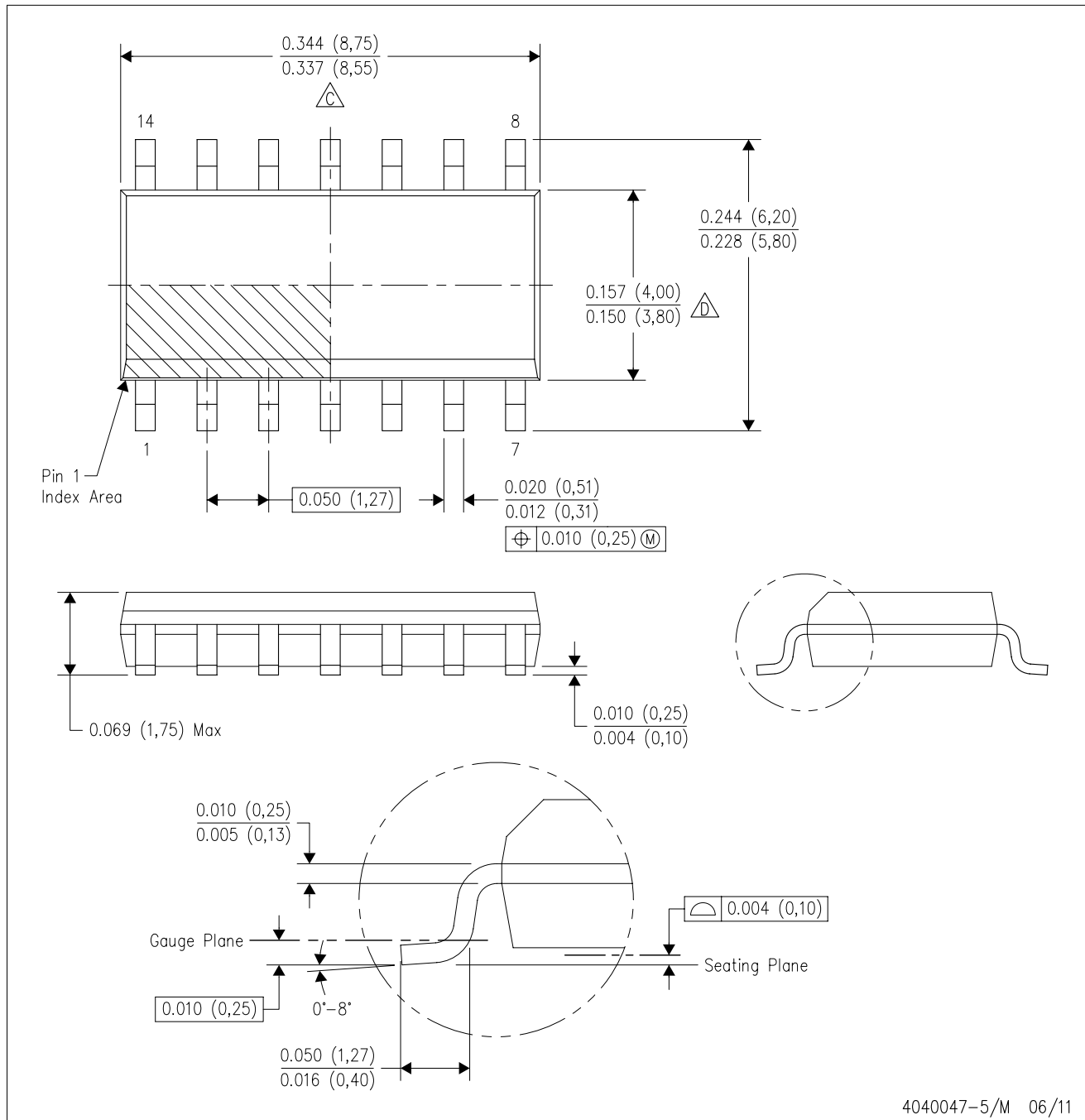

- NOTES:
- A. All linear dimensions are in inches (millimeters).
  - B. This drawing is subject to change without notice.
  - Body length does not include mold flash, protrusions, or gate burrs. Mold flash, protrusions, or gate burrs shall not exceed 0.006 (0,15) each side.
  - Body width does not include interlead flash. Interlead flash shall not exceed 0.017 (0,43) each side.
  - E. Reference JEDEC MS-012 variation AB.

## IMPORTANT NOTICE

Texas Instruments Incorporated and its subsidiaries (TI) reserve the right to make corrections, enhancements, improvements and other changes to its semiconductor products and services per JESD46, latest issue, and to discontinue any product or service per JESD48, latest issue. Buyers should obtain the latest relevant information before placing orders and should verify that such information is current and complete. All semiconductor products (also referred to herein as "components") are sold subject to TI's terms and conditions of sale supplied at the time of order acknowledgment.

TI warrants performance of its components to the specifications applicable at the time of sale, in accordance with the warranty in TI's terms and conditions of sale of semiconductor products. Testing and other quality control techniques are used to the extent TI deems necessary to support this warranty. Except where mandated by applicable law, testing of all parameters of each component is not necessarily performed.

TI assumes no liability for applications assistance or the design of Buyers' products. Buyers are responsible for their products and applications using TI components. To minimize the risks associated with Buyers' products and applications, Buyers should provide adequate design and operating safeguards.

TI does not warrant or represent that any license, either express or implied, is granted under any patent right, copyright, mask work right, or other intellectual property right relating to any combination, machine, or process in which TI components or services are used. Information published by TI regarding third-party products or services does not constitute a license to use such products or services or a warranty or endorsement thereof. Use of such information may require a license from a third party under the patents or other intellectual property of the third party, or a license from TI under the patents or other intellectual property of TI.

Reproduction of significant portions of TI information in TI data books or data sheets is permissible only if reproduction is without alteration and is accompanied by all associated warranties, conditions, limitations, and notices. TI is not responsible or liable for such altered documentation. Information of third parties may be subject to additional restrictions.

Resale of TI components or services with statements different from or beyond the parameters stated by TI for that component or service voids all express and any implied warranties for the associated TI component or service and is an unfair and deceptive business practice. TI is not responsible or liable for any such statements.

Buyer acknowledges and agrees that it is solely responsible for compliance with all legal, regulatory and safety-related requirements concerning its products, and any use of TI components in its applications, notwithstanding any applications-related information or support that may be provided by TI. Buyer represents and agrees that it has all the necessary expertise to create and implement safeguards which anticipate dangerous consequences of failures, monitor failures and their consequences, lessen the likelihood of failures that might cause harm and take appropriate remedial actions. Buyer will fully indemnify TI and its representatives against any damages arising out of the use of any TI components in safety-critical applications.

In some cases, TI components may be promoted specifically to facilitate safety-related applications. With such components, TI's goal is to help enable customers to design and create their own end-product solutions that meet applicable functional safety standards and requirements. Nonetheless, such components are subject to these terms.

No TI components are authorized for use in FDA Class III (or similar life-critical medical equipment) unless authorized officers of the parties have executed a special agreement specifically governing such use.

Only those TI components which TI has specifically designated as military grade or "enhanced plastic" are designed and intended for use in military/aerospace applications or environments. Buyer acknowledges and agrees that any military or aerospace use of TI components which have **not** been so designated is solely at the Buyer's risk, and that Buyer is solely responsible for compliance with all legal and regulatory requirements in connection with such use.

TI has specifically designated certain components as meeting ISO/TS16949 requirements, mainly for automotive use. In any case of use of non-designated products, TI will not be responsible for any failure to meet ISO/TS16949.

### Products

Audio	<a href="http://www.ti.com/audio">www.ti.com/audio</a>
Amplifiers	<a href="http://amplifier.ti.com">amplifier.ti.com</a>
Data Converters	<a href="http://dataconverter.ti.com">dataconverter.ti.com</a>
DLP® Products	<a href="http://www.dlp.com">www.dlp.com</a>
DSP	<a href="http://dsp.ti.com">dsp.ti.com</a>
Clocks and Timers	<a href="http://www.ti.com/clocks">www.ti.com/clocks</a>
Interface	<a href="http://interface.ti.com">interface.ti.com</a>
Logic	<a href="http://logic.ti.com">logic.ti.com</a>
Power Mgmt	<a href="http://power.ti.com">power.ti.com</a>
Microcontrollers	<a href="http://microcontroller.ti.com">microcontroller.ti.com</a>
RFID	<a href="http://www.ti-rfid.com">www.ti-rfid.com</a>
OMAP Applications Processors	<a href="http://www.ti.com/omap">www.ti.com/omap</a>
Wireless Connectivity	<a href="http://www.ti.com/wirelessconnectivity">www.ti.com/wirelessconnectivity</a>

### Applications

Automotive and Transportation	<a href="http://www.ti.com/automotive">www.ti.com/automotive</a>
Communications and Telecom	<a href="http://www.ti.com/communications">www.ti.com/communications</a>
Computers and Peripherals	<a href="http://www.ti.com/computers">www.ti.com/computers</a>
Consumer Electronics	<a href="http://www.ti.com/consumer-apps">www.ti.com/consumer-apps</a>
Energy and Lighting	<a href="http://www.ti.com/energy">www.ti.com/energy</a>
Industrial	<a href="http://www.ti.com/industrial">www.ti.com/industrial</a>
Medical	<a href="http://www.ti.com/medical">www.ti.com/medical</a>
Security	<a href="http://www.ti.com/security">www.ti.com/security</a>
Space, Avionics and Defense	<a href="http://www.ti.com/space-avionics-defense">www.ti.com/space-avionics-defense</a>
Video and Imaging	<a href="http://www.ti.com/video">www.ti.com/video</a>

### TI E2E Community

[e2e.ti.com](http://e2e.ti.com)