

Product Preview

256K x 36 and 512K x 18 Bit Flow-Through BurstRAM Synchronous Fast Static RAM

The MCM63F837 and MCM63F919 are 8M-bit synchronous fast static RAMs designed to provide a burstable, high performance, secondary cache for the PowerPC™ and other high performance microprocessors. The MCM63F837 (organized as 256K words by 36 bits) and the MCM63F919 (organized as 512K words by 18 bits) are fabricated in Motorola's high performance silicon gate CMOS technology. Synchronous design allows precise cycle control with the use of an external clock (K).

Addresses (SA), data inputs (DQx), and all control signals except output enable (\overline{G}), sleep mode (ZZ), and linear burst order (\overline{LBO}) are clock (K) controlled through positive-edge-triggered noninverting registers.

Bursts can be initiated with either \overline{ADSP} or \overline{ADSC} input pins. Subsequent burst addresses can be generated internally by the MCM63F837 and MCM63F919 (burst sequence operates in linear or interleaved mode dependent upon the state of \overline{LBO}) and controlled by the burst address advance (\overline{ADV}) input pin.

Write cycles are internally self-timed and are initiated by the rising edge of the clock (K) input. This feature eliminates complex off-chip write pulse generation and provides increased timing flexibility for incoming signals.

Synchronous byte write (\overline{SBx}), synchronous global write (\overline{SGW}), and synchronous write enable (\overline{SW}) are provided to allow writes to either individual bytes or to all bytes. The bytes are designated as "a", "b", etc. \overline{SBa} controls DQa, \overline{SBb} controls DQb, etc. Individual bytes are written if the selected byte writes \overline{SBx} are asserted with \overline{SW} . All bytes are written if either \overline{SGW} is asserted or if all \overline{SBx} and \overline{SW} are asserted.

For read cycles, a flow-through SRAM allows output data to simply flow freely from the memory array.

The MCM63F837 and MCM63F919 operate from a 3.3 V core power supply and all outputs operate on a 2.5 V or 3.3 V power supply. All inputs and outputs are JEDEC standard JESD8-A and JESD8-5 compatible.

- MCM63F837/MCM63F919-7 = 7 ns Access/8.5 ns Cycle (117 MHz)
MCM63F837/MCM63F919-8 = 8 ns Access/10 ns Cycle (100 MHz)
MCM63F837/MCM63F919-8.5 = 8.5 ns Access/11 ns Cycle (90 MHz)
- 3.3 V $\pm 5\%$ Core Power Supply, 2.5 V or 3.3 V I/O Supply
- \overline{ADSP} , \overline{ADSC} , and \overline{ADV} Burst Control Pins
- Selectable Burst Sequencing Order (Linear/Interleaved)
- Single-Cycle Deselect Timing
- Internally Self-Timed Write Cycle
- Byte Write and Global Write Control
- Sleep Mode (ZZ)
- Simplified JTAG
- JEDEC Standard 100-Pin TQFP and 119-Bump PBGA Packages

MCM63F837
MCM63F919

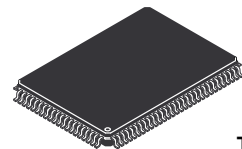

TQ PACKAGE
TQFP
CASE 983A-01

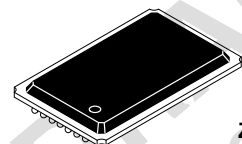

ZP PACKAGE
PBGA
CASE 999-02

The PowerPC name is a trademark of IBM Corp., used under license therefrom.

This document contains information on a product under development. Motorola reserves the right to change or discontinue this product without notice.

REV 1
8/23/99



FUNCTIONAL BLOCK DIAGRAM

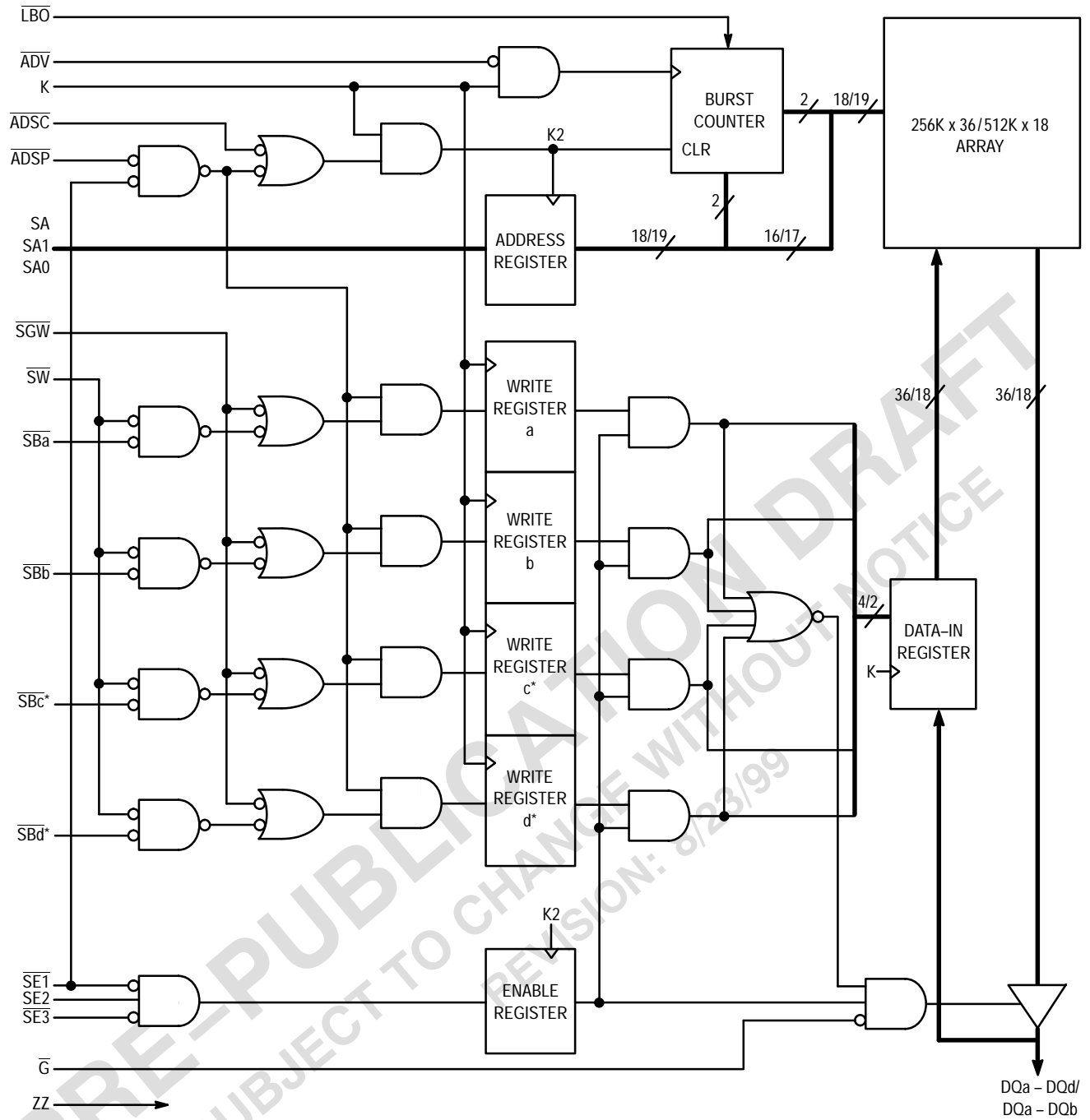

* Valid only for MCM63F837.

Freescale Semiconductor, Inc.

Freescale Semiconductor, Inc.

MCM63F837 TQFP PIN DESCRIPTIONS

Pin Locations	Symbol	Type	Description
85	\overline{ADSC}	Input	Synchronous Address Status Controller: Active low, interrupts any ongoing burst and latches a new external address. Used to initiate a READ, WRITE, or chip deselect.
84	\overline{ADSP}	Input	Synchronous Address Status Processor: Active low, interrupts any ongoing burst and latches a new external address. Used to initiate a new READ, WRITE, or chip deselect (exception — chip deselect does not occur when ADSP is asserted and SE1 is high).
83	\overline{ADV}	Input	Synchronous Address Advance: Increments address count in accordance with counter type selected (linear/interleaved).
(a) 51, 52, 53, 56, 57, 58, 59, 62, 63 (b) 68, 69, 72, 73, 74, 75, 78, 79, 80 (c) 1, 2, 3, 6, 7, 8, 9, 12, 13 (d) 18, 19, 22, 23, 24, 25, 28, 29, 30	DQx	I/O	Synchronous Data I/O: "x" refers to the byte being read or written (byte a, b, c, d).
86	\overline{G}	Input	Asynchronous Output Enable Input: Low — enables output buffers (DQx pins). High — DQx pins are high impedance.
89	K	Input	Clock: This signal registers the address, data in, and all control signals except \overline{G} , LBO, and ZZ.
31	\overline{LBO}	Input	Linear Burst Order Input: This pin must remain in steady state (this signal not registered or latched). It must be tied high or low. Low — linear burst counter (68K/PowerPC). High — interleaved burst counter (486/i960/Pentium).
32, 33, 34, 35, 43, 44, 45, 46, 47, 48, 49, 50, 81, 82, 99, 100	SA	Input	Synchronous Address Inputs: These inputs are registered and must meet setup and hold times.
36, 37	SA1, SA0	Input	Synchronous Address Inputs: These pins must be wired to the two LSBs of the address bus for proper burst operation. These inputs are registered and must meet setup and hold times.
93, 94, 95, 96 (a) (b) (c) (d)	\overline{SBx}	Input	Synchronous Byte Write Inputs: "x" refers to the byte being written (byte a, b, c, d). \overline{SGW} overrides \overline{SBx} .
98	$\overline{SE1}$	Input	Synchronous Chip Enable: Active low to enable chip. Negated high — blocks \overline{ADSP} or deselects chip when \overline{ADSC} is asserted.
97	SE2	Input	Synchronous Chip Enable: Active high for depth expansion.
92	$\overline{SE3}$	Input	Synchronous Chip Enable: Active low for depth expansion.
88	\overline{SGW}	Input	Synchronous Global Write: This signal writes all bytes regardless of the status of the \overline{SBx} and \overline{SW} signals. If only byte write signals \overline{SBx} are being used, tie this pin high.
87	\overline{SW}	Input	Synchronous Write: This signal writes only those bytes that have been selected using the byte write \overline{SBx} pins. If only byte write signals \overline{SBx} are being used, tie this pin low.
64	ZZ	Input	Sleep Mode: This active high asynchronous signal places the RAM into the lowest power mode. The ZZ pin disables the RAMs internal clock when placed in this mode. When ZZ is negated, the RAM remains in low power mode until it is commanded to READ or WRITE. Data integrity is maintained upon returning to normal operation.
15, 41, 65, 91	V _{DD}	Supply	Core Power Supply.
4, 11, 20, 27, 54, 61, 70, 77	V _{DDQ}	Supply	I/O Power Supply.
5, 10, 17, 21, 26, 40, 55, 60, 67, 71, 76, 90	V _{SS}	Supply	Ground.
14, 16, 38, 39, 42, 66	NC	—	No Connection: There is no connection to the chip.

Freescale Semiconductor, Inc.

MCM63F837 PBGA PIN DESCRIPTIONS

Pin Locations	Symbol	Type	Description
4B	\overline{ADSC}	Input	Synchronous Address Status Controller: Active low, interrupts any ongoing burst and latches a new external address. Used to initiate a READ, WRITE, or chip deselect.
4A	\overline{ADSP}	Input	Synchronous Address Status Processor: Active low, interrupts any ongoing burst and latches a new external address. Used to initiate a new READ, WRITE, or chip deselect (exception — chip deselect does not occur when \overline{ADSP} is asserted and $\overline{SE1}$ is high).
4G	\overline{ADV}	Input	Synchronous Address Advance: Increments address count in accordance with counter type selected (linear/interleaved).
(a) 6K, 7K, 6L, 7L, 6M, 6N, 7N, 6P, 7P (b) 6D, 7D, 6E, 7E, 6F, 6G, 7G, 6H, 7H (c) 1D, 2D, 1E, 2E, 2F, 1G, 2G, 1H, 2H (d) 1K, 2K, 1L, 2L, 2M, 1N, 2N, 1P, 2P	DQx	I/O	Synchronous Data I/O: "x" refers to the byte being read or written (byte a, b, c, d).
4F	\overline{G}	Input	Asynchronous Output Enable Input: Low — enables output buffers (DQx pins). High — DQx pins are high impedance.
4K	K	Input	Clock: This signal registers the address, data in, and all control signals except \overline{G} , LBO, and ZZ.
3R	\overline{LBO}	Input	Linear Burst Order Input: This pin must remain in steady state (this signal not registered or latched). It must be tied high or low. Low — linear burst counter (68K/PowerPC). High — interleaved burst counter (486/i960/Pentium).
2A, 3A, 5A, 6A, 3B, 5B, 6B, 2C, 3C, 5C, 6C, 2R, 6R, 3T, 4T, 5T	SA	Input	Synchronous Address Inputs: These inputs are registered and must meet setup and hold times.
4N, 4P	SA1, SA0	Input	Synchronous Address Inputs: These pins must be wired to the two LSBs of the address bus for proper burst operation. These inputs are registered and must meet setup and hold times.
5L, 5G, 3G, 3L (a) (b) (c) (d)	\overline{SBx}	Input	Synchronous Byte Write Inputs: "x" refers to the byte being written (byte a, b, c, d). \overline{SGW} overrides \overline{SBx} .
4E	$\overline{SE1}$	Input	Synchronous Chip Enable: Active low to enable chip. Negated high — blocks \overline{ADSP} or deselects chip when \overline{ADSC} is asserted.
2B	SE2	Input	Synchronous Chip Enable: Active high for depth expansion.
4H	\overline{SGW}	Input	Synchronous Global Write: This signal writes all bytes regardless of the status of the \overline{SBx} and \overline{SW} signals. If only byte write signals \overline{SBx} are being used, tie this pin high.
4M	\overline{SW}	Input	Synchronous Write: This signal writes only those bytes that have been selected using the byte write \overline{SBx} pins. If only byte write signals \overline{SBx} are being used, tie this pin low.
4U	TCK	Input	Boundary Scan Pin, Test Clock: If boundary scan is not used, TCK must be tied to V_{DD} or V_{SS} .
3U	TDI	Input	Boundary Scan Pin, Test Data In.
5U	TDO	Output	Boundary Scan Pin, Test Data Out.
2U	TMS	Input	Boundary Scan Pin, Test Mode Select.
6U	\overline{TRST}	Input	Boundary Scan Pin, Asynchronous Test Reset: If boundary scan is not used, \overline{TRST} must be tied to V_{SS} .
7T	ZZ	Input	Sleep Mode: This active high asynchronous signal places the RAM into the lowest power mode. The ZZ pin disables the RAMs internal clock when placed in this mode. When ZZ is negated, the RAM remains in low power mode until it is commanded to READ or WRITE. Data integrity is maintained upon returning to normal operation.
4C, 2J, 4J, 6J, 4R	V_{DD}	Supply	Core Power Supply.
1A, 7A, 1F, 7F, 1J, 7J, 1M, 7M, 1U, 7U	V_{DDQ}	Supply	I/O Power Supply.
3D, 5D, 3E, 5E, 3F, 5F, 3H, 5H, 3K, 5K, 3M, 5M, 3N, 5N, 3P, 5P	V_{SS}	Supply	Ground.
1B, 7B, 1C, 7C, 4D, 3J, 5J, 4L, 1R, 5R, 7R, 1T, 2T, 6T	NC	—	No Connection: There is no connection to the chip.

Freescale Semiconductor, Inc.

MCM63F919 PIN ASSIGNMENTS

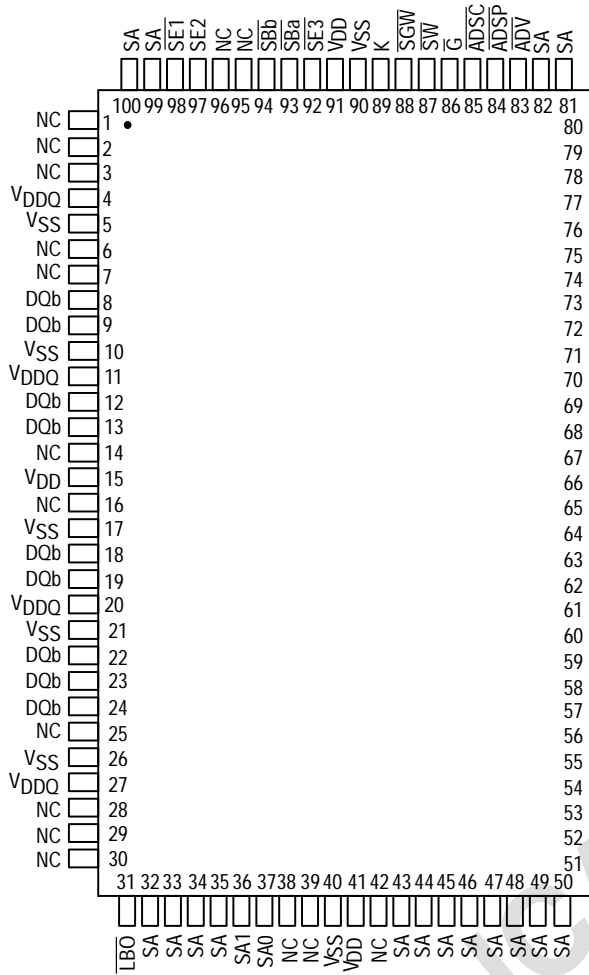

100-PIN TQFP
TOP VIEW

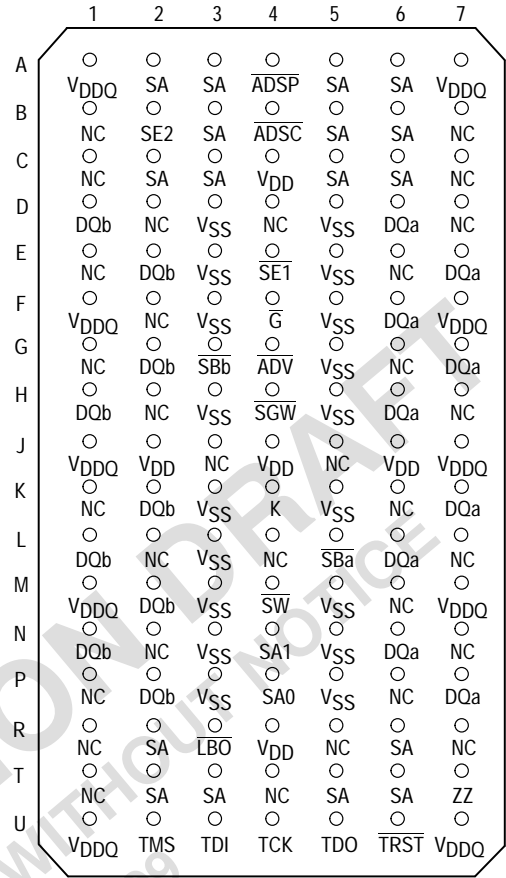

119-BUMP PBGA
TOP VIEW

Not to Scale

Freescale Semiconductor, Inc.

Freescale Semiconductor, Inc.

MCM63F919 TQFP PIN DESCRIPTIONS

Pin Locations	Symbol	Type	Description
85	\overline{ADSC}	Input	Synchronous Address Status Controller: Active low, interrupts any ongoing burst and latches a new external address. Used to initiate a READ, WRITE, or chip deselect.
84	\overline{ADSP}	Input	Synchronous Address Status Processor: Active low, interrupts any ongoing burst and latches a new external address. Used to initiate a new READ, WRITE, or chip deselect (exception — chip deselect does not occur when ADSP is asserted and SE1 is high).
83	\overline{ADV}	Input	Synchronous Address Advance: Increments address count in accordance with counter type selected (linear/interleaved).
(a) 58, 59, 62, 63, 68, 69, 72, 73, 74 (b) 8, 9, 12, 13, 18, 19, 22, 23, 24	DQx	I/O	Synchronous Data I/O: "x" refers to the byte being read or written (byte a, b).
86	\overline{G}	Input	Asynchronous Output Enable Input: Low — enables output buffers (DQx pins). High — DQx pins are high impedance.
89	K	Input	Clock: This signal registers the address, data in, and all control signals except \overline{G} , \overline{LBO} , and ZZ.
31	\overline{LBO}	Input	Linear Burst Order Input: This pin must remain in steady state (this signal not registered or latched). It must be tied high or low. Low — linear burst counter (68K/PowerPC). High — interleaved burst counter (486/i960/Pentium).
32, 33, 34, 35, 43, 44, 45, 46, 47, 48, 49, 50, 80, 81, 82, 99, 100	SA	Input	Synchronous Address Inputs: These inputs are registered and must meet setup and hold times.
36, 37	SA1, SA0	Input	Synchronous Address Inputs: These pins must be wired to the two LSBs of the address bus for proper burst operation. These inputs are registered and must meet setup and hold times.
93, 94 (a) (b)	\overline{SBx}	Input	Synchronous Byte Write Inputs: "x" refers to the byte being written (byte a, b). SGW overrides \overline{SBx} .
88	\overline{SGW}	Input	Synchronous Global Write: This signal writes all bytes regardless of the status of the \overline{SBx} and \overline{SW} signals. If only byte write signals \overline{SBx} are being used, tie this pin high.
98	$\overline{SE1}$	Input	Synchronous Chip Enable: Active low to enable chip. Negated high — blocks ADSP or deselects chip when \overline{ADSC} is asserted.
97	SE2	Input	Synchronous Chip Enable: Active high for depth expansion.
92	$\overline{SE3}$	Input	Synchronous Chip Enable: Active low for depth expansion.
87	SW	Input	Synchronous Write: This signal writes only those bytes that have been selected using the byte write \overline{SBx} pins. If only byte write signals \overline{SBx} are being used, tie this pin low.
64	ZZ	Input	Sleep Mode: This active high asynchronous signal places the RAM into the lowest power mode. The ZZ pin disables the RAMs internal clock when placed in this mode. When ZZ is negated, the RAM remains in low power mode until it is commanded to READ or WRITE. Data integrity is maintained upon returning to normal operation.
15, 41, 65, 91	V _{DD}	Supply	Core Power Supply.
4, 11, 20, 27, 54, 61, 70, 77	V _{DDQ}	Supply	I/O Power Supply.
5, 10, 17, 21, 26, 40, 55, 60, 67, 71, 76, 90	V _{SS}	Supply	Ground.
1, 2, 3, 6, 7, 14, 16, 25, 28, 29, 30, 38, 39, 42, 51, 52, 53, 56, 57, 66, 75, 78, 79, 95, 96	NC	—	No Connection: There is no connection to the chip.

Freescale Semiconductor, Inc.

MCM63F919 PBGA PIN DESCRIPTIONS

Pin Locations	Symbol	Type	Description
4B	\overline{ADSC}	Input	Synchronous Address Status Controller: Active low, interrupts any ongoing burst and latches a new external address. Used to initiate a READ, WRITE, or chip deselect.
4A	\overline{ADSP}	Input	Synchronous Address Status Processor: Active low, interrupts any ongoing burst and latches a new external address. Used to initiate a new READ, WRITE, or chip deselect (exception — chip deselect does not occur when \overline{ADSP} is asserted and $\overline{SE1}$ is high).
4G	\overline{ADV}	Input	Synchronous Address Advance: Increments address count in accordance with counter type selected (linear/interleaved).
(a) 6D, 7E, 6F, 7G, 6H, 7K, 6L, 6N, 7P (b) 1D, 2E, 2G, 1H, 2K, 1L, 2M, 1N, 2P	DQx	I/O	Synchronous Data I/O: "x" refers to the byte being read or written (byte a, b).
4F	\overline{G}	Input	Asynchronous Output Enable Input: Low — enables output buffers (DQx pins). High — DQx pins are high impedance.
4K	K	Input	Clock: This signal registers the address, data in, and all control signals except \overline{G} , \overline{LBO} , and ZZ.
3R	\overline{LBO}	Input	Linear Burst Order Input: This pin must remain in steady state (this signal not registered or latched). It must be tied high or low. Low — linear burst counter (68K/PowerPC). High — interleaved burst counter (486/i960/Pentium).
2A, 3A, 5A, 6A, 3B, 5B, 6B, 2C, 3C, 5C, 6C, 2R, 6R, 2T, 3T, 5T, 6T	SA	Input	Synchronous Address Inputs: These inputs are registered and must meet setup and hold times.
4N, 4P	SA1, SA0	Input	Synchronous Address Inputs: These pins must be wired to the two LSBs of the address bus for proper burst operation. These inputs are registered and must meet setup and hold times.
5L, 3G (a) (b)	\overline{SBx}	Input	Synchronous Byte Write Inputs: "x" refers to the byte being written (byte a, b). SGW overrides \overline{SBx} .
4E	$\overline{SE1}$	Input	Synchronous Chip Enable: Active low to enable chip. Negated high — blocks \overline{ADSP} or deselects chip when \overline{ADSC} is asserted.
2B	SE2	Input	Synchronous Chip Enable: Active high for depth expansion.
4H	\overline{SGW}	Input	Synchronous Global Write: This signal writes all bytes regardless of the status of the \overline{SBx} and \overline{SW} signals. If only byte write signals \overline{SBx} are being used, tie this pin high.
4M	\overline{SW}	Input	Synchronous Write: This signal writes only those bytes that have been selected using the byte write \overline{SBx} pins. If only byte write signals \overline{SBx} are being used, tie this pin low.
4U	TCK	Input	Boundary Scan Pin, Test Clock: If boundary scan is not used, TCK must be tied to V_{DD} or V_{SS} .
3U	TDI	Input	Boundary Scan Pin, Test Data In.
5U	TDO	Output	Boundary Scan Pin, Test Data Out.
2U	TMS	Input	Boundary Scan Pin, Test Mode Select.
6U	\overline{TRST}	Input	Boundary Scan Pin, Asynchronous Test Reset: If boundary scan is not used, \overline{TRST} must be tied to V_{SS} .
7T	ZZ	Input	Sleep Mode: This active high asynchronous signal places the RAM into the lowest power mode. The ZZ pin disables the RAMs internal clock when placed in this mode. When ZZ is negated, the RAM remains in low power mode until it is commanded to READ or WRITE. Data integrity is maintained upon returning to normal operation.
4C, 2J, 4J, 6J, 4R	V_{DD}	Supply	Core Power Supply.
1A, 7A, 1F, 7F, 1J, 7J, 1M, 7M, 1U, 7U	V_{DDQ}	Supply	I/O Power Supply.
3D, 5D, 3E, 5E, 3F, 5F, 5G, 3H, 5H, 3K, 5K, 3L, 3M, 5M, 3N, 5N, 3P, 5P	V_{SS}	Supply	Ground.
1B, 7B, 1C, 7C, 2D, 4D, 7D, 1E, 6E, 2F, 1G, 6G, 2H, 7H, 3J, 5J, 1K, 6K, 2L, 4L, 7L, 6M, 2N, 7N, 1P, 6P, 1R, 5R, 7R, 1T, 4T	NC	—	No Connection: There is no connection to the chip.

Freescale Semiconductor, Inc.

TRUTH TABLE (See Notes 1 Through 5)

Next Cycle	Address Used	$\overline{SE1}$	SE2	$\overline{SE3}$	\overline{ADSP}	\overline{ADSC}	\overline{ADV}	\overline{G}^3	DQx	Write 2, 4
Deselect	None	1	X	X	X	0	X	X	High-Z	X
Deselect	None	0	X	1	0	X	X	X	High-Z	X
Deselect	None	0	0	X	0	X	X	X	High-Z	X
Deselect	None	X	X	1	1	0	X	X	High-Z	X
Deselect	None	X	0	X	1	0	X	X	High-Z	X
Begin Read	External	0	1	0	0	X	X	0	High-Z	X
Begin Read	External	0	1	0	1	0	X	0	High-Z	READ
Continue Read	Next	X	X	X	1	1	0	1	High-Z	READ
Continue Read	Next	X	X	X	1	1	0	0	DQ	READ
Continue Read	Next	1	X	X	X	1	0	1	High-Z	READ
Continue Read	Next	1	X	X	X	1	0	0	DQ	READ
Suspend Read	Current	X	X	X	1	1	1	1	High-Z	READ
Suspend Read	Current	X	X	X	1	1	1	0	DQ	READ
Suspend Read	Current	1	X	X	X	1	1	1	High-Z	READ
Suspend Read	Current	1	X	X	X	1	1	0	DQ	READ
Begin Write	External	0	1	0	1	0	X	X	High-Z	WRITE
Continue Write	Next	X	X	X	1	1	0	X	High-Z	WRITE
Continue Write	Next	1	X	X	X	1	0	X	High-Z	WRITE
Suspend Write	Current	X	X	X	1	1	1	X	High-Z	WRITE
Suspend Write	Current	1	X	X	X	1	1	X	High-Z	WRITE

NOTES:

1. X = don't care. 1 = logic high. 0 = logic low.
2. Write is defined as either 1) any SBx and SW low or 2) \overline{SGW} is low.
3. \overline{G} is an asynchronous signal and is not sampled by the clock K. \overline{G} drives the bus immediately (t_{GLQX}) following \overline{G} going low.
4. On write cycles that follow read cycles, \overline{G} must be negated prior to the start of the write cycle to ensure proper write data setup times. \overline{G} must also remain negated at the completion of the write cycle to ensure proper write data hold times.

ASYNCHRONOUS TRUTH TABLE

Operation	ZZ	\overline{G}	I/O Status
Read	L	L	Data Out (DQx)
Read	L	H	High-Z
Write	L	X	High-Z
Deselected	L	X	High-Z
Sleep	H	X	High-Z

LINEAR BURST ADDRESS TABLE ($\overline{LB0} = V_{SS}$)

1st Address (External)	2nd Address (Internal)	3rd Address (Internal)	4th Address (Internal)
X...X00	X...X01	X...X10	X...X11
X...X01	X...X10	X...X11	X...X00
X...X10	X...X11	X...X00	X...X01
X...X11	X...X00	X...X01	X...X10

INTERLEAVED BURST ADDRESS TABLE ($\overline{LB0} = V_{DD}$)

1st Address (External)	2nd Address (Internal)	3rd Address (Internal)	4th Address (Internal)
X...X00	X...X01	X...X10	X...X11
X...X01	X...X00	X...X11	X...X10
X...X10	X...X11	X...X00	X...X01
X...X11	X...X10	X...X01	X...X00

Freescale Semiconductor, Inc.

WRITE TRUTH TABLE

Cycle Type	\overline{SGW}	\overline{SW}	\overline{SBa}	\overline{SBb}	\overline{SBc} (See Note 1)	\overline{SBd} (See Note 1)
Read	H	H	X	X	X	X
Read	H	L	H	H	H	H
Write Byte a	H	L	L	H	H	H
Write Byte b	H	L	H	L	H	H
Write Byte c (See Note 1)	H	L	H	H	L	H
Write Byte d (See Note 1)	H	L	H	H	H	L
Write All Bytes	H	L	L	L	L	L
Write All Bytes	L	X	X	X	X	X

NOTE:

- Valid Only for MCM63F837.

ABSOLUTE MAXIMUM RATINGS (See Note 1)

Rating	Symbol	Value	Unit	Notes
Power Supply Voltage	V_{DD}	$V_{SS} - 0.5$ to 4.6	V	
I/O Supply Voltage	V_{DDQ}	$V_{SS} - 0.5$ to V_{DD}	V	2
Input Voltage Relative to V_{SS} for Any Pin Except V_{DD}	V_{in}, V_{out}	$V_{SS} - 0.5$ to $V_{DD} + 0.5$	V	2
Input Voltage (Three-State I/O)	V_{IT}	$V_{SS} - 0.5$ to $V_{DDQ} + 0.5$	V	2
Output Current (per I/O)	I_{out}	± 20	mA	
Package Power Dissipation	P_D	1.6	W	3
Temperature Under Bias	T_{bias}	-10 to 85	$^{\circ}C$	
Storage Temperature	T_{stg}	-55 to 125	$^{\circ}C$	

This device contains circuitry to protect the inputs against damage due to high static voltages or electric fields; however, it is advised that normal precautions be taken to avoid application of any voltage higher than maximum rated voltages to this high-impedance circuit.

NOTES:

- Permanent device damage may occur if ABSOLUTE MAXIMUM RATINGS are exceeded. Functional operation should be restricted to RECOMMENDED OPERATING CONDITIONS. Exposure to higher than recommended voltages for extended periods of time could affect device reliability.
- This is a steady-state DC parameter that is in effect after the power supply has achieved its nominal operating level. Power sequencing is not necessary.
- Power dissipation capability is dependent upon package characteristics and use environment. See Package Thermal Characteristics.

PACKAGE THERMAL CHARACTERISTICS

Rating	Symbol	Max	Unit	Notes
--------	--------	-----	------	-------

TQFP

Junction to Ambient (@ 200 lfm)	Single-Layer Board Four-Layer Board	$R_{\theta JA}$	40 25	$^{\circ}C/W$	1, 2
Junction to Board (Bottom)		$R_{\theta JB}$	17	$^{\circ}C/W$	3
Junction to Case (Top)		$R_{\theta JC}$	9	$^{\circ}C/W$	4

PBGA

Junction to Ambient (@ 200 lfm)	Single-Layer Board Four-Layer Board	$R_{\theta JA}$	38 22	$^{\circ}C/W$	1, 2
Junction to Board (Bottom)		$R_{\theta JB}$	14	$^{\circ}C/W$	3
Junction to Case (Top)		$R_{\theta JC}$	5	$^{\circ}C/W$	4

NOTES:

- Junction temperature is a function of on-chip power dissipation, package thermal resistance, mounting site (board) temperature, ambient temperature, air flow, board population, and board thermal resistance.
- Per SEMI G38-87.
- Indicates the average thermal resistance between the die and the printed circuit board.
- Indicates the average thermal resistance between the die and the case top surface via the cold plate method (MIL SPEC-883 Method 1012.1).

Freescale Semiconductor, Inc.

DC OPERATING CONDITIONS AND CHARACTERISTICS

($V_{DD} = 3.3 \text{ V} \pm 5\%$, $T_A = 0 \text{ to } 70^\circ\text{C}$, Unless Otherwise Noted)

RECOMMENDED OPERATING CONDITIONS AND DC CHARACTERISTICS (Voltages Referenced to $V_{SS} = 0 \text{ V}$)

Parameter	Symbol	Min	Typ	Max	Unit
2.5 V I/O SUPPLY					
Supply Voltage	V_{DD}	3.135	3.3	3.465	V
I/O Supply Voltage	V_{DDQ}	2.375	2.5	2.9	V
Input Low Voltage	V_{IL}	-0.3*	—	0.7	V
Input High Voltage	V_{IH}	1.7	—	$V_{DD} + 0.3^{**}$	V
Input High Voltage I/O Pins	V_{IH2}	1.7	—	$V_{DDQ} + 0.3^{**}$	V
Output Low Voltage ($I_{OL} = 2 \text{ mA}$)	V_{OL}	—	—	0.7	V
Output High Voltage ($I_{OH} = -2 \text{ mA}$)	V_{OH}	1.7	—	—	V

3.3 V I/O SUPPLY

Supply Voltage	V_{DD}	3.135	3.3	3.465	V
I/O Supply Voltage	V_{DDQ}	3.135	3.3	V_{DD}	V
Input Low Voltage	V_{IL}	-0.5*	—	0.8	V
Input High Voltage	V_{IH}	2	—	$V_{DD} + 0.5^{**}$	V
Input High Voltage I/O Pins	V_{IH2}	2	—	$V_{DDQ} + 0.5^{**}$	V
Output Low Voltage ($I_{OL} = 8 \text{ mA}$)	V_{OL}	—	—	0.4	V
Output High Voltage ($I_{OH} = -4 \text{ mA}$)	V_{OH}	2.4	—	—	V

* Undershoot: $V_{IL} \leq -1.5 \text{ V}$ for $t < 20\% t_{KHKH}$.

** Overshoot: $V_{IH}/V_{IH2} \leq V_{DD}/V_{DDQ} + 1.0 \text{ V}$ (not to exceed 4.6 V) for $t < 20\% t_{KHKH}$.

SUPPLY CURRENTS

Parameter	Symbol	Min	Typ	Max	Unit	Notes
Input Leakage Current ($0 \text{ V} \leq V_{in} \leq V_{DD}$)	$I_{kg}(I)$	—	—	± 1	μA	1
Output Leakage Current ($0 \text{ V} \leq V_{in} \leq V_{DDQ}$)	$I_{kg}(O)$	—	—	± 1	μA	
AC Supply Current (Device Selected, All Outputs Open, Freq = Max) Includes V_{DD} Only	I_{DDA}	—	—	TBD	mA	2, 3, 4
CMOS Standby Supply Current (Device Deselected, Freq = 0, $V_{DD} = \text{Max}$, All Inputs Static at CMOS Levels)	I_{SB2}	—	—	TBD	mA	5, 6
Sleep Mode Supply Current (Device Deselected, Freq = Max, $V_{DD} = \text{Max}$, All Other Inputs Static at CMOS Levels, $ZZ \geq V_{DD} - 0.2 \text{ V}$)	I_{ZZ}	—	—	TBD	mA	1, 5, 6
TTL Standby Supply Current (Device Deselected, Freq = 0, $V_{DD} = \text{Max}$, All Inputs Static at TTL Levels)	I_{SB3}	—	—	TBD	mA	5, 7
Clock Running (Device Deselected, Freq = Max, $V_{DD} = \text{Max}$, All Inputs Toggling at CMOS Levels)	I_{SB4}	—	—	TBD	mA	5, 6
Static Clock Running (Device Deselected, Freq = Max, $V_{DD} = \text{Max}$, All Inputs Static at TTL Levels)	I_{SB5}	—	—	TBD	mA	5, 7

NOTES:

1. \overline{LBO} and ZZ pins have an internal pull-up and pull-down, and will exhibit leakage currents of $\pm 5 \mu\text{A}$.
2. Reference AC Operating Conditions and Characteristics for input and timing.
3. All addresses transition simultaneously low (LSB) then high (MSB).
4. Data states are all zero.
5. Device is deselected as defined by the Truth Table.
6. CMOS levels for I/Os are $V_{IT} \leq V_{SS} + 0.2 \text{ V}$ or $\geq V_{DDQ} - 0.2 \text{ V}$. CMOS levels for other inputs are $V_{in} \leq V_{SS} + 0.2 \text{ V}$ or $\geq V_{DD} - 0.2 \text{ V}$.
7. TTL levels for I/Os are $V_{IT} \leq V_{IL}$ or $\geq V_{IH2}$. TTL levels for other inputs are $V_{in} \leq V_{IL}$ or $\geq V_{IH}$.

Freescale Semiconductor, Inc.

CAPACITANCE (f = 1.0 MHz, T_A = 0 to 70°C, Periodically Sampled Rather Than 100% Tested)

Parameter	Symbol	Min	Typ	Max	Unit
Input Capacitance	C _{in}	—	2	4	pF
Input/Output Capacitance	C _{I/O}	—	3	5	pF

AC OPERATING CONDITIONS AND CHARACTERISTICS

(V_{DD} = 3.3 V ±5%, T_A = 0 to 70°C, Unless Otherwise Noted)

Input Timing Measurement Reference Level 1.5 V
 Input Pulse Levels 0 to 3.0 V
 Input Rise/Fall Time 1.0 V/ns (20% to 80%)

Output Timing Reference Level 1.5 V
 Output Load See Figure 1 Unless Otherwise Noted

READ/WRITE CYCLE TIMING (See Notes 1 and 2)

Parameter	Symbol	MCM63F837-7 MCM63F919-7		MCM63F837-8 MCM63F919-8		MCM63F837-8.5 MCM63F919-8.5		Unit	Notes
		Min	Max	Min	Max	Min	Max		
Cycle Time	t _{KHKH}	8.5	—	10	—	11	—	ns	
Clock High Pulse Width	t _{KHKL}	3.4	—	4	—	4.5	—	ns	
Clock Low Pulse Width	t _{KLKH}	3.4	—	4	—	4.5	—	ns	
Clock Access Time	t _{KHQV}	—	7	—	8	—	8.5	ns	
Output Enable to Output Valid	t _{GLQV}	—	3.5	—	3.5	—	3.5	ns	
Clock High to Output Active	t _{KHQX1}	2	—	2	—	2	—	ns	3, 4, 5
Clock High to Output Change	t _{KHQX2}	2	—	2	—	2	—	ns	3, 4
Output Enable to Output Active	t _{GLQX}	0	—	0	—	0	—	ns	3, 4
Output Disable to Q High-Z	t _{GHQZ}	—	3.5	—	3.5	—	3.5	ns	3, 4
Clock High to Q High-Z	t _{KHQZ}	2	3.5	2	3.5	2	3.5	ns	3, 4, 5
Sleep Mode Standby	t _{ZZS}	—	2	—	2	—	2	cycles	
Sleep Mode Recovery	t _{ZZREC}	—	2	—	2	—	2	cycles	
Sleep Mode to Q High-Z	t _{ZZQZ}	—	15	—	15	—	15	ns	
Setup Times: Address ADSP, ADSC, ADV Data In Write Chip Enable	t _{ADKH} t _{ADSKH} t _{DVKH} t _{WVKH} t _{EVKH}	1.5	—	1.5	—	1.5	—	ns	
Hold Times: Address ADSP, ADSC, ADV Data In Write Chip Enable	t _{KHAX} t _{KHADSX} t _{KHDX} t _{KHWX} t _{KHEX}	0.5	—	0.5	—	0.5	—	ns	

NOTES:

1. Write is defined as either any \overline{SBx} and \overline{SW} low or \overline{SGW} is low. Chip Enable is defined as $\overline{SE1}$ low, $\overline{SE2}$ high, and $\overline{SE3}$ low whenever \overline{ADSP} or \overline{ADSC} is asserted.
2. All read and write cycle timings are referenced from K or \overline{G} .
3. Measured at ±200 mV from steady state.
4. This parameter is sampled and not 100% tested.
5. At any given voltage and temperature, t_{KHQZ} max is less than t_{KHQX1} min for a given device and from device to device.

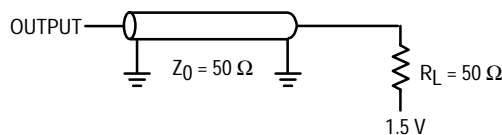

Figure 1. AC Test Load

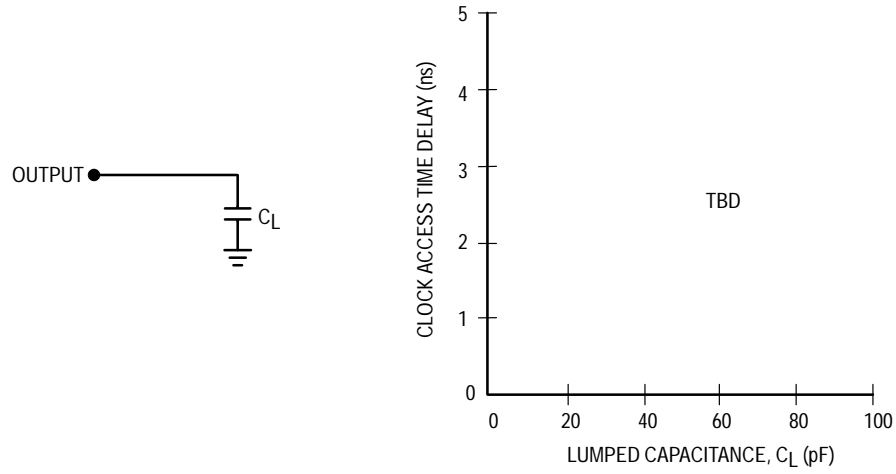

Figure 2. Lumped Capacitive Load and Typical Derating Curve

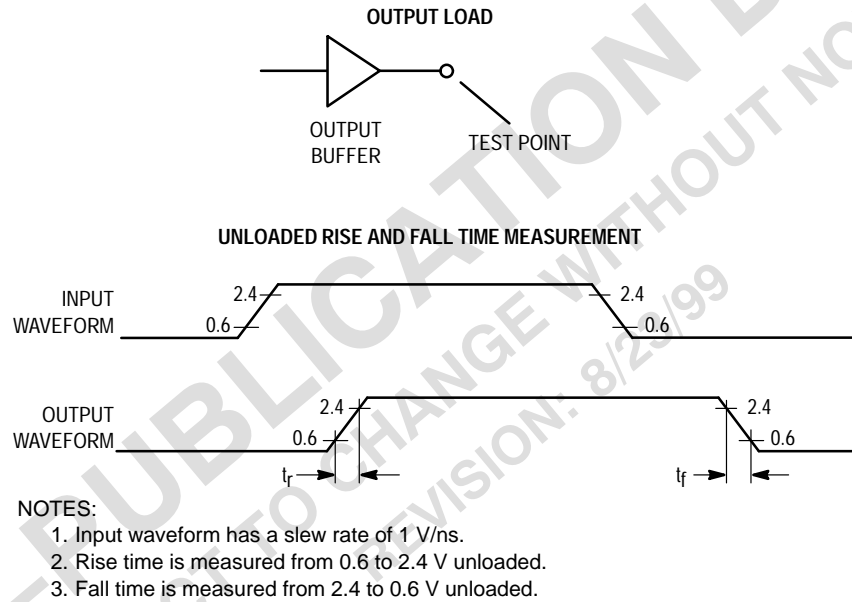
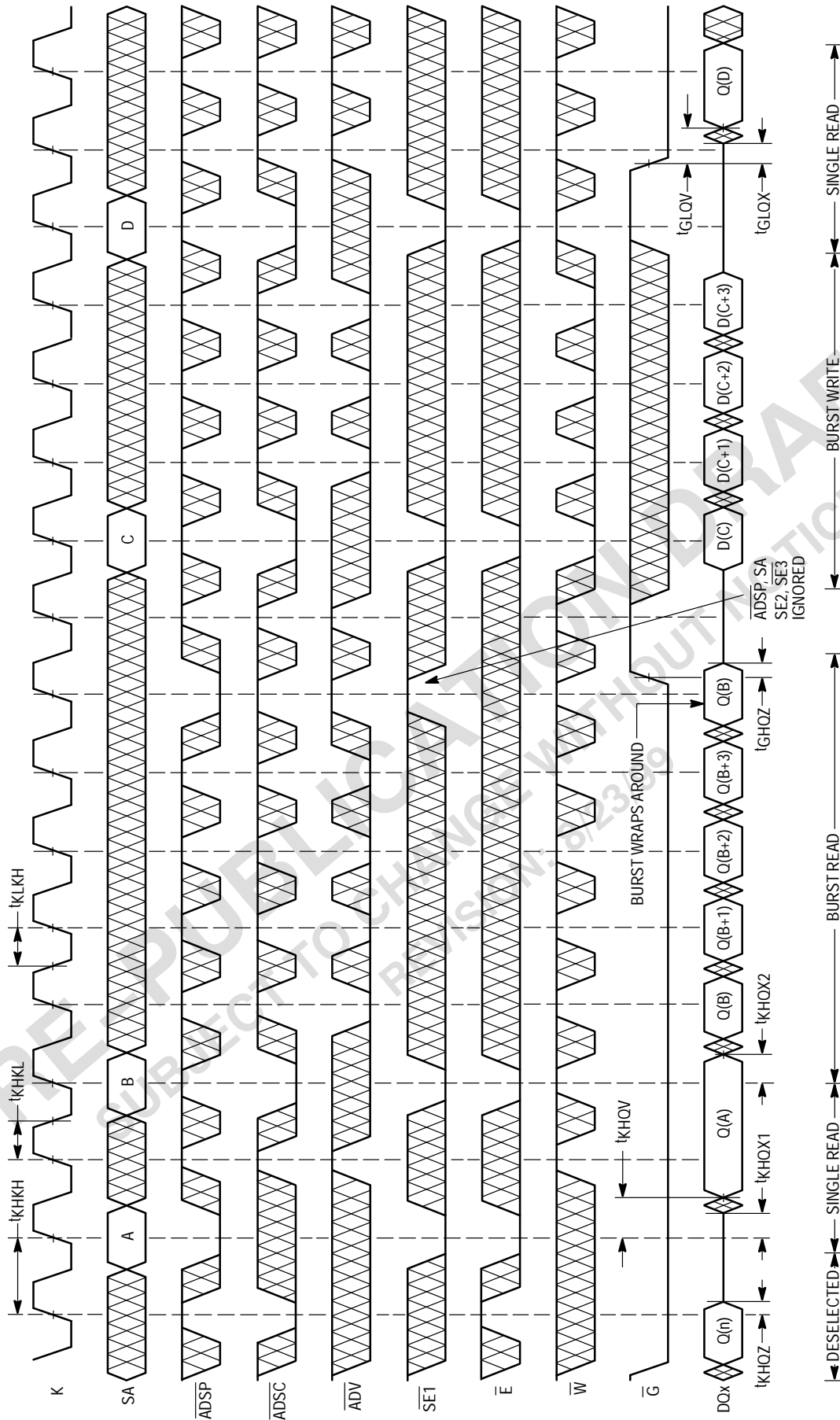

Figure 3. Unloaded Rise and Fall Time Characterization

PRE-PUBLICATION DRAFT
SUBJECT TO CHANGE WITHOUT NOTICE

READ/WRITE CYCLES



NOTE: \overline{E} low = $\overline{SE2}$ high and $\overline{SE3}$ low.
 \overline{W} low = \overline{SGW} low and/or \overline{SW} and \overline{SBx} low.

READ CYCLES

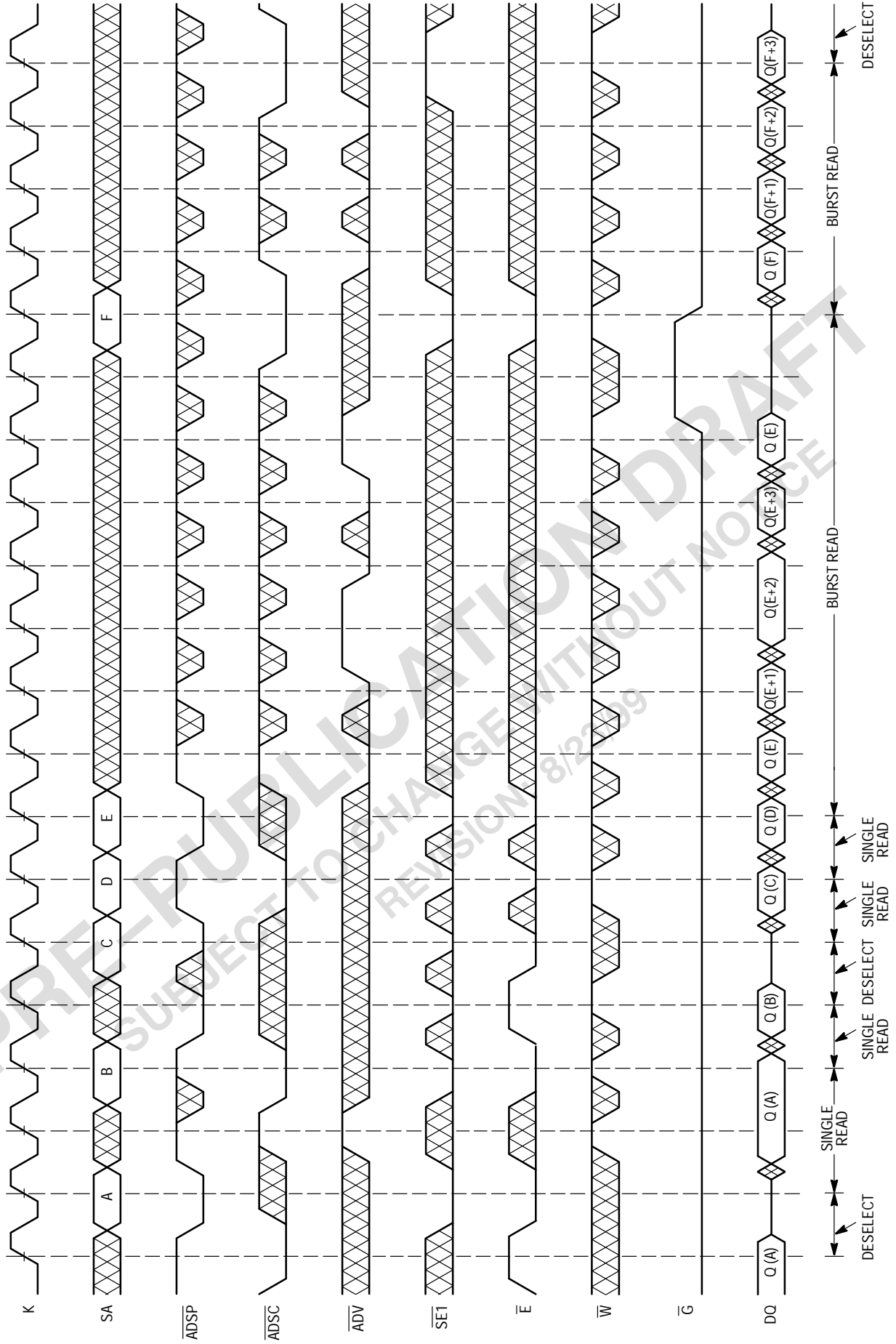

WRITE CYCLES

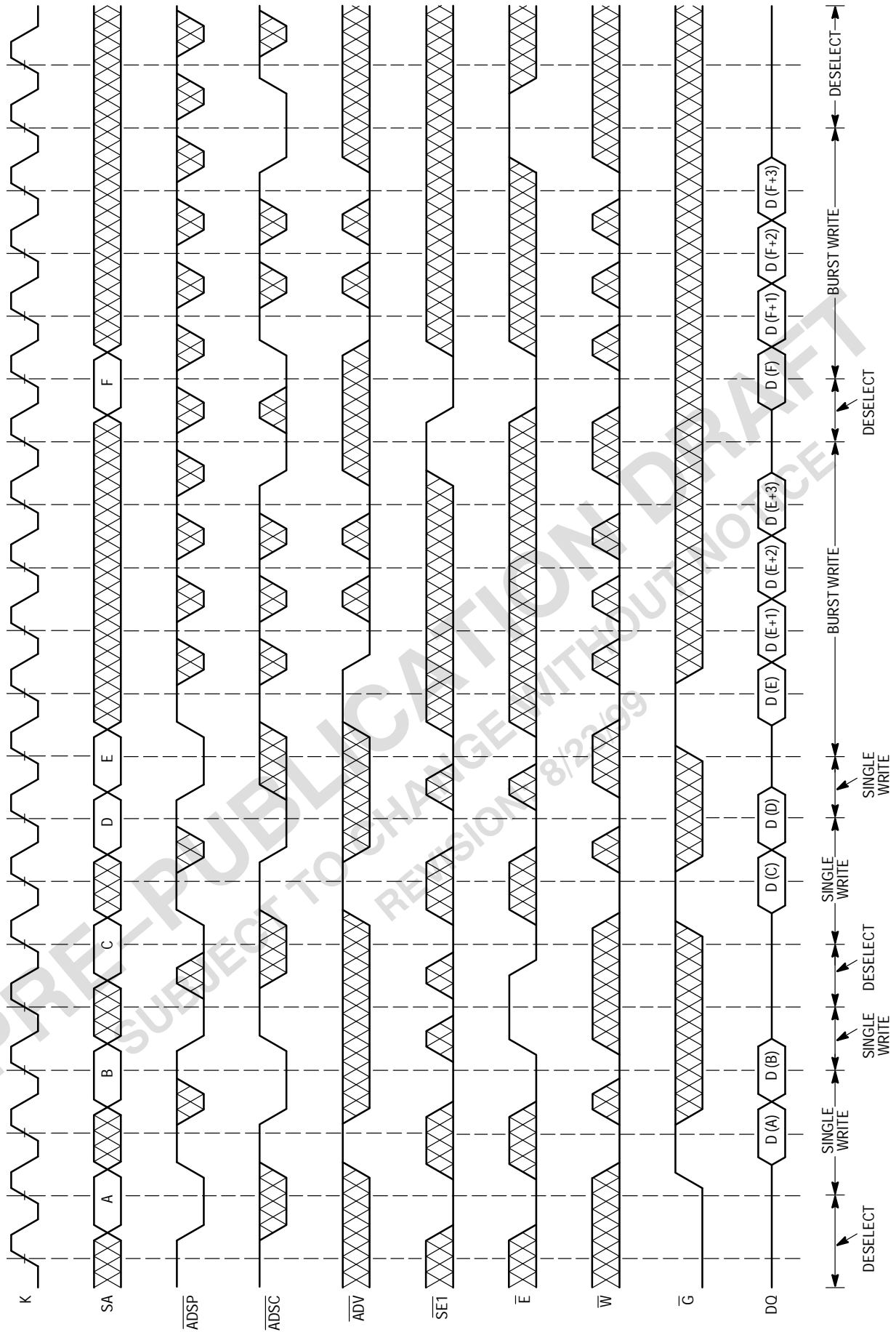

SLEEP MODE TIMING

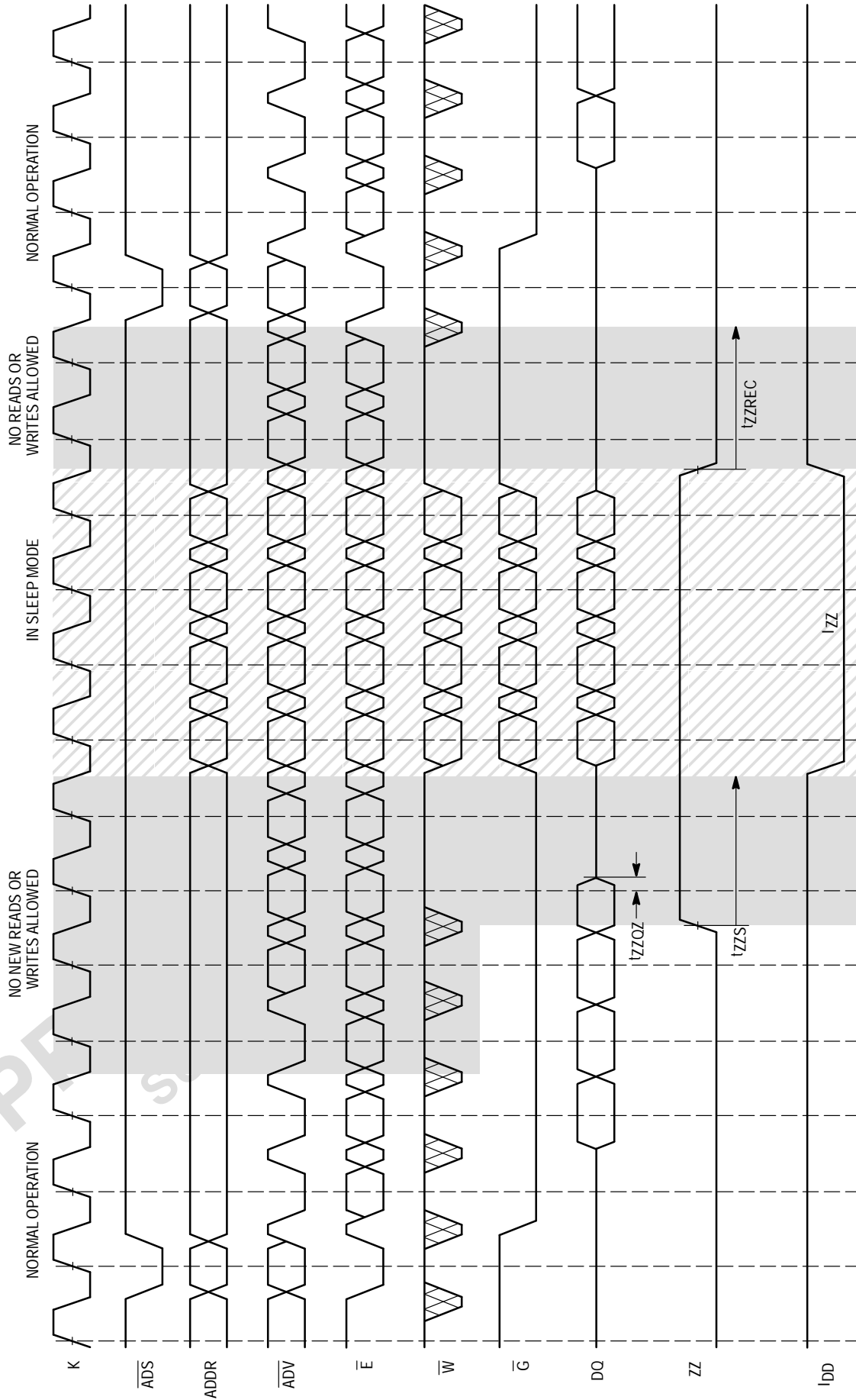

NOTE: ADS low = \overline{ADSC} low or \overline{ADSP} low.
 ADS high = both \overline{ADSC} , \overline{ADSP} high.
 E low = SE1 low, SE2 high, SE3 low.
 IZZ (max) specifications will not be met if inputs toggle.

APPLICATION INFORMATION

SLEEP MODE

A sleep mode feature, the ZZ pin, has been implemented on the MCM63F837 and MCM63F919. It allows the system designer to place the RAM in the lowest possible power condition by asserting ZZ. The sleep mode timing diagram shows the different modes of operation: Normal Operation, No READ/WRITE Allowed, and Sleep Mode. Each mode has its own set of constraints and conditions that are allowed.

Normal Operation: All inputs must meet setup and hold times prior to sleep and t_{ZZREC} nanoseconds after recovering from sleep. Clock (K) must also meet cycle, high, and low times during these periods. Two cycles prior to sleep, initiation of either a read or write operation is not allowed.

No READ/WRITE: During the period of time just prior to sleep and during recovery from sleep, the assertion of either \overline{ADSP} , \overline{ADSC} , or any write signal is not allowed. If a write operation occurs during these periods, the memory array may be corrupted. Validity of data out from the RAM can not be guaranteed immediately after ZZ is asserted (prior to being in sleep).

Sleep Mode: The RAM automatically deselects itself. The RAM disconnects its internal clock buffer. The external clock may continue to run without impacting the RAMs sleep

current (I_{ZZ}). All inputs are allowed to toggle — the RAM will not be selected and perform any reads or writes. However, if inputs toggle, the I_{ZZ} (max) specification will not be met.

Note: It is invalid to go from stop clock mode directly into sleep mode.

NON-BURST SYNCHRONOUS OPERATION

Although this BurstRAM has been designed for PowerPC and other high end MPU-based systems, these SRAMs can be used in other high speed L2 cache or memory applications that do not require the burst address feature. Most L2 caches designed with a synchronous interface can make use of the MCM63F837 and MCM63F919. The burst counter feature of the BurstRAM can be disabled, and the SRAM can be configured to act upon a continuous stream of addresses. See Figure 4.

CONTROL PIN TIE VALUES EXAMPLE ($H \geq V_{IH}$, $L \leq V_{IL}$)

Non-Burst	ADSP	ADSC	ADV	SE1	SE2	LBO
Sync Non-Burst, Flow-Through SRAM	H	L	H	L	H	X

NOTE: Although X is specified in the table as a don't care, the pin must be tied either high or low.

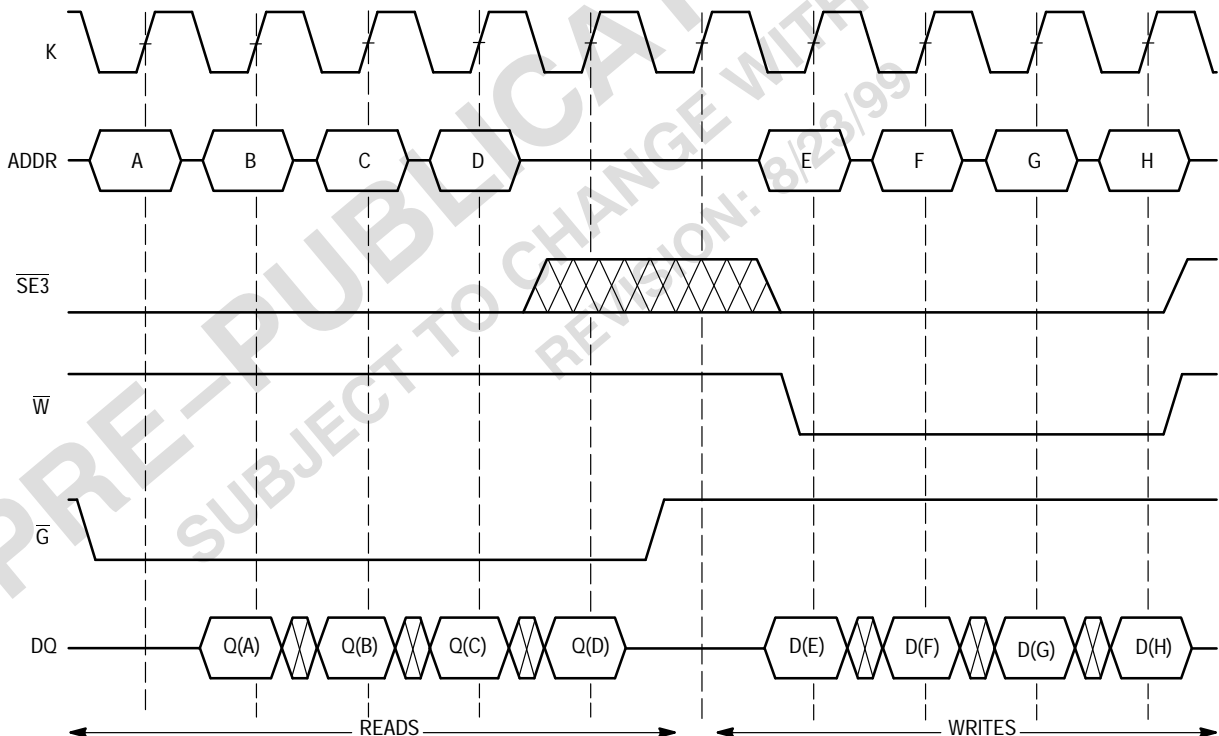

Figure 4. Example Configuration as Non-Burst Synchronous SRAM

Freescale Semiconductor, Inc.

SERIAL BOUNDARY SCAN TEST ACCESS PORT OPERATION

OVERVIEW

The serial boundary scan test access port (TAP) on this RAM is designed to operate in a manner consistent with IEEE Standard 1149.1–1990 (commonly referred to as JTAG), but does not implement all of the functions required for IEEE 1149.1 compliance. Certain functions have been modified or eliminated because their implementation places extra delays in the RAMs critical speed path. Nevertheless, the RAM supports the standard TAP controller architecture (the TAP controller is the state machine that controls the

TAPs operation) and can be expected to function in a manner that does not conflict with the operation of devices with IEEE Standard 1149.1 compliant TAPs. The TAP operates using a 3.3 V tolerant logic level signaling.

DISABLING THE TEST ACCESS PORT

It is possible to use this device without utilizing the TAP. To disable the TAP controller without interfering with normal operation of the device, $\overline{\text{TRST}}$ should be tied low and TCK, TDI, and TMS should be pulled through a resistor to 3.3 V. TDO should be left unconnected.

TAP DC OPERATING CHARACTERISTICS

($T_A = 0$ to 70°C , Unless Otherwise Noted)

Parameter	Symbol	Min	Max	Unit	Notes
Input Logic Low	V_{IL1}	-0.5	0.8	V	
Input Logic High	V_{IH1}	2	3.6	V	
Input Leakage Current	I_{lk}	—	± 10	μA	1
Output Logic Low	V_{OL1}	—	0.4	V	2
Output Logic High	V_{OH1}	2.4	—	V	

NOTES:

- $0\text{ V} \leq V_{in} \leq V_{DDQ}$ for all logic input pins.
- For $V_{OL} = 0.4\text{ V}$, $14\text{ mA} \leq I_{OL} \leq 28\text{ mA}$.

TAP AC OPERATING CONDITIONS AND CHARACTERISTICS

($T_A = 0$ to 70°C , Unless Otherwise Noted)

AC TEST CONDITIONS

Parameter	Value	Unit
Input Timing Reference Level	1.5	V
Input Pulse Levels	0 to 3.0	V
Input Rise/Fall Time (20% to 80%)	1	V/ns
Output Timing Reference Level	1.5	V
Output Load (See Figure 1 Unless Otherwise Noted)	—	—

TAP CONTROLLER TIMING

Parameter	Symbol	Min	Max	Unit	Notes	
TCK Cycle Time	t_{THTH}	60	—	ns		
TCK Clock High Time	t_{TH}	25	—	ns		
TCK Clock Low Time	t_{TL}	25	—	ns		
TDO Access Time	t_{TLQV}	1	10	ns		
\overline{TRST} Pulse Width	t_{TSRT}	40	—	ns		
Setup Times	Capture	t_{CS}	5	—	ns	1
	TDI	t_{DVTH}	5			
	TMS	t_{MVTH}	5			
Hold Times	Capture	t_{CH}	13	—	ns	1
	TDI	t_{THDX}	14			
	TMS	t_{THMX}	14			

NOTE:

- t_{CS} and t_{CH} define the minimum pauses in RAM I/O transitions to assure accurate pad data capture.

TAP CONTROLLER TIMING DIAGRAM

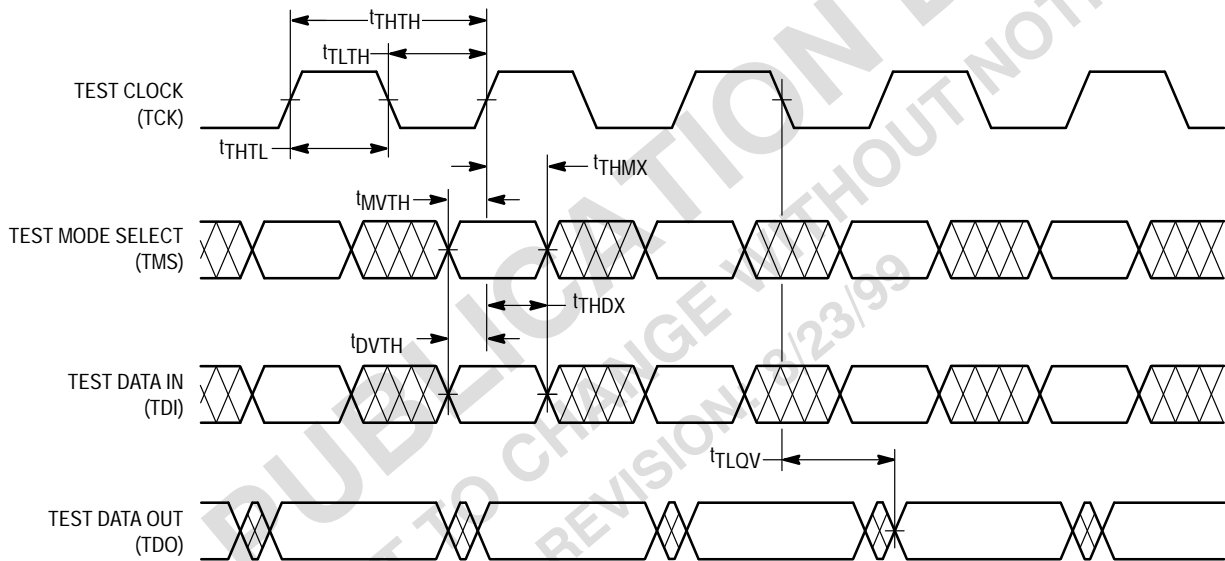

TEST ACCESS PORT PINS

TCK — TEST CLOCK (INPUT)

Clocks all TAP events. All inputs are captured on the rising edge of TCK and all outputs propagate from the falling edge of TCK.

TMS — TEST MODE SELECT (INPUT)

The TMS input is sampled on the rising edge of TCK. This is the command input for the TAP controller state machine. An undriven TMS input will not produce the same result as a logic 1 input level (not IEEE 1149.1 compliant).

TDI — TEST DATA IN (INPUT)

The TDI input is sampled on the rising edge of TCK. This is the input side of the serial registers placed between TDI and TDO. The register placed between TDI and TDO is determined by the state of the TAP controller state machine and the instruction that is currently loaded in the TAP instruction register (see Figure 6). An undriven TDI pin will not produce the same result as a logic 1 input level (not IEEE 1149.1 compliant).

TDO — TEST DATA OUT (OUTPUT)

Output that is active depending on the state of the TAP state machine (see Figure 6). Output changes in response to the falling edge of TCK. This is the output side of the serial registers placed between TDI and TDO.

$\overline{\text{TRST}}$ — TAP RESET

The $\overline{\text{TRST}}$ is an asynchronous input that resets the TAP controller and preloads the instruction register with the IDCODE command. This type of reset does not affect the operation of the system logic. The reset affects test logic only.

TEST ACCESS PORT REGISTERS

OVERVIEW

The various TAP registers are selected (one at a time) via the sequences of 1s and 0s input to the TMS pin as the TCK is strobed. Each of the TAPs registers are serial shift registers that capture serial input data on the rising edge of TCK and push serial data out on subsequent falling edge of TCK. When a register is selected it is “placed” between the TDI and TDO pins.

INSTRUCTION REGISTER

The instruction register holds the instructions that are executed by the TAP controller when it is moved into the run test/idle or the various data register states. The instructions are 3 bits long. The register can be loaded when it is placed between the TDI and TDO pins. The parallel outputs of the instruction register are automatically preloaded with the IDCODE instruction when $\overline{\text{TRST}}$ is asserted or whenever the controller is placed in the test-logic-reset state. The two least significant bits of the serial instruction register are loaded with a binary “or” pattern in the capture-IR state.

BYPASS REGISTER

The bypass register is a single bit register that can be placed between TDI and TDO. It allows serial test data to be

passed through the RAMs TAP to another device in the scan chain with as little delay as possible.

BOUNDARY SCAN REGISTER

The boundary scan register is identical in length to the number of active input and I/O connections on the RAM (not counting the TAP pins). This also includes a number of place holder locations (always set to a logic 0) reserved for density upgrade address pins. There are a total of 70 bits in the case of the x36 device and 51 bits in the case of the x18 device. The boundary scan register, under the control of the TAP controller, is loaded with the contents of the RAMs I/O ring when the controller is in capture-DR state and then is placed between the TDI and TDO pins when the controller is moved to shift-DR state.

The Bump/Bit Scan Order table describes which device bump connects to each boundary scan register location. The first column defines the bit's position in the boundary scan register. The shift register bit nearest TDO (i.e., first to be shifted out) is defined as bit 1. The second column is the name of the input or I/O at the bump and the third column is the bump number.

IDENTIFICATION (ID) REGISTER

The ID register is a 32-bit register that is loaded with a device and vendor specific 32-bit code when the controller is put in capture-DR state with the IDCODE command loaded in the instruction register. The code is loaded from a 32-bit on-chip ROM. It describes various attributes of the RAM as indicated below. The register is then placed between the TDI and TDO pins when the controller is moved into shift-DR state. Bit 0 in the register is the LSB and the first to reach TDO when shifting begins.

ID Register Presence Indicator

Bit No.	0
Value	1

Motorola JEDEC ID Code (Compressed Format, per IEEE Standard 1149.1-1990)

Bit No.	11	10	9	8	7	6	5	4	3	2	1
Value	0	0	0	0	0	0	0	1	1	1	0

Reserved For Future Use

Bit No.	17	16	15	14	13	12
Value	x	x	x	x	x	x

Device Width

Bit No.	22	21	20	19	18
256K x 36	0	0	1	0	0
512K x 18	0	0	0	1	1

Device Depth

Bit No.	27	26	25	24	23
256K x 36	0	0	1	1	0
512K x 18	0	0	1	1	1

Revision Number

Bit No.	31	30	29	28
Value	0	0	0	1

Figure 5. ID Register Bit Meanings

Freescale Semiconductor, Inc.

MCM63F837 BOUNDARY SCAN ORDER

Bit No.	Signal Name	Bump ID
1	SA	TBD
2	SA	TBD
3	SA	TBD
4	SA	TBD
5	SA	TBD
6	SA	TBD
7	SA	TBD
8	DQa	TBD
9	DQa	TBD
10	DQa	TBD
11	DQa	TBD
12	DQa	TBD
13	DQa	TBD
14	DQa	TBD
15	DQa	TBD
16	DQa	TBD
17	ZZ	TBD
18	DQb	TBD
19	DQb	TBD
20	DQb	TBD
21	DQb	TBD
22	DQb	TBD
23	DQb	TBD
24	DQb	TBD
25	DQb	TBD
26	DQb	TBD
27	SA	TBD
28	SA	TBD
29	ADV	TBD
30	ADSP	TBD
31	ADSC	TBD
32	\overline{G}	TBD
33	\overline{SW}	TBD
34	\overline{SGW}	TBD

Bit No.	Signal Name	Bump ID
35	K	TBD
36	$\overline{SE3}$	TBD
37	\overline{SBa}	TBD
38	\overline{SBb}	TBD
39	\overline{SBc}	TBD
40	\overline{SBd}	TBD
41	SE2	TBD
42	$\overline{SE1}$	TBD
43	SA	TBD
44	SA	TBD
45	DQc	TBD
46	DQc	TBD
47	DQc	TBD
48	DQc	TBD
49	DQc	TBD
50	DQc	TBD
51	DQc	TBD
52	DQc	TBD
53	DQc	TBD
54	VSS	TBD
55	DQd	TBD
56	DQd	TBD
57	DQd	TBD
58	DQd	TBD
59	DQd	TBD
60	DQd	TBD
61	DQd	TBD
62	DQd	TBD
63	DQd	TBD
64	LBO	TBD
65	SA	TBD
66	SA	TBD
67	SA	TBD
68	SA	TBD
69	SA1	TBD
70	SA0	TBD

Freescale Semiconductor, Inc.

MCM63F919 BOUNDARY SCAN ORDER

Bit No.	Signal Name	Bump ID
1	SA	TBD
2	SA	TBD
3	SA	TBD
4	SA	TBD
5	SA	TBD
6	SA	TBD
7	SA	TBD
8	DQa	TBD
9	DQa	TBD
10	DQa	TBD
11	DQa	TBD
12	ZZ	TBD
13	DQa	TBD
14	DQa	TBD
15	DQa	TBD
16	DQa	TBD
17	DQa	TBD
18	SA	TBD
19	SA	TBD
20	SA	TBD
21	\overline{ADV}	TBD
22	\overline{ADSP}	TBD
23	\overline{ADSC}	TBD
24	\overline{G}	TBD
25	SW	TBD

Bit No.	Signal Name	Bump ID
26	SGW	TBD
27	K	TBD
28	$\overline{SE3}$	TBD
29	\overline{SBa}	TBD
30	\overline{SBb}	TBD
31	SE2	TBD
32	$\overline{SE1}$	TBD
33	SA	TBD
34	SA	TBD
35	DQb	TBD
36	DQb	TBD
37	DQb	TBD
38	VSS	TBD
39	DQb	TBD
40	DQb	TBD
41	DQb	TBD
42	DQb	TBD
43	DQb	TBD
44	DQb	TBD
45	\overline{LBO}	TBD
46	SA	TBD
47	SA	TBD
48	SA	TBD
49	SA	TBD
50	SA1	TBD
51	SA0	TBD

TAP CONTROLLER INSTRUCTION SET

OVERVIEW

There are two classes of instructions defined in the IEEE Standard 1149.1–1990; the standard (public) instructions and device specific (private) instructions. Some public instructions, are mandatory for IEEE 1149.1 compliance. Optional public instructions must be implemented in prescribed ways.

Although the TAP controller in this device follows the IEEE 1149.1 conventions, it is not IEEE 1149.1 compliant because some of the mandatory instructions are not fully implemented. The TAP on this device may be used to monitor all input and I/O pads, but can not be used to load address, data, or control signals into the RAM or to preload the I/O buffers. In other words, the device will not perform IEEE 1149.1 EXTEST, INTEST, or the preload portion of the SAMPLE/PRELOAD command.

When the TAP controller is placed in capture–IR state, the two least significant bits of the instruction register are loaded with 01. When the controller is moved to the shift–IR state the instruction register is placed between TDI and TDO. In this state the desired instruction is serially loaded through the TDI input (while the previous contents are shifted out at TDO). For all instructions, the TAP executes newly loaded instructions only when the controller is moved to update–IR state. The TAP instruction sets for this device are listed in the following tables.

STANDARD (PUBLIC) INSTRUCTIONS

BYPASS

The BYPASS instruction is loaded in the instruction register when the bypass register is placed between TDI and TDO. This occurs when the TAP controller is moved to the shift–DR state. This allows the board level scan path to be shortened to facilitate testing of other devices in the scan path.

SAMPLE/PRELOAD

SAMPLE/PRELOAD is an IEEE 1149.1 mandatory public instruction. When the SAMPLE/PRELOAD instruction is loaded in the Instruction register, moving the TAP controller out of the capture–DR state loads the data in the RAMs input and I/O buffers into the boundary scan register. Because the RAM clock(s) are independent from the TAP clock (TCK), it is

possible for the TAP to attempt to capture the I/O ring contents while the input buffers are in transition (i.e., in a metastable state). Although allowing the TAP to sample metastable inputs will not harm the device, repeatable results can not be expected. RAM input signals must be stabilized for long enough to meet the TAPs input data capture setup plus hold time (t_{CS} plus t_{CH}). The RAMs clock inputs need not be paused for any other TAP operation except capturing the I/O ring contents into the boundary scan register.

Moving the controller to shift–DR state then places the boundary scan register between the TDI and TDO pins. Because the PRELOAD portion of the command is not implemented in this device, moving the controller to the update–DR state with the SAMPLE/PRELOAD instruction loaded in the instruction register has the same effect as the pause–DR command. This functionality is not IEEE 1149.1 compliant.

EXTEST

EXTEST is an IEEE 1149.1 mandatory public instruction. It is to be executed whenever the instruction register, whatever length it may be in the device, is loaded with all logic 0s. EXTEST is not implemented in this device.

IDCODE

The IDCODE instruction causes the ID ROM to be loaded into the ID register when the controller is in capture–DR mode and places the ID register between the TDI and TDO pins in shift–DR mode. The IDCODE instruction is the default instruction loaded in at \overline{TRST} assertion and any time the controller is placed in the test–logic–reset state.

THE DEVICE SPECIFIC (PUBLIC) INSTRUCTION

SAMPLE–Z

If the SAMPLE–Z instruction is loaded in the instruction register, all DQ pins are forced to an inactive drive state (High–Z) and the bypass register is connected between TDI and TDO when the TAP controller is moved to the shift–DR state.

THE DEVICE SPECIFIC (PRIVATE) INSTRUCTION

NO OP

Do not use these instructions; they are reserved for future use.

Freescale Semiconductor, Inc.

STANDARD AND DEVICE SPECIFIC (PUBLIC) INSTRUCTION CODES

Instruction	Code*	Description
IDCODE	001**	Preloads ID register and places it between TDI and TDO. Does not affect RAM operation.
HIGH-Z	010	Captures I/O ring contents. Places the bypass register between TDI and TDO. Forces all DQ pins to High-Z. NOT IEEE 1149.1 COMPLIANT.
BYPASS	011	Places bypass register between TDI and TDO. Does not affect RAM operation. NOT IEEE 1149.1 COMPLIANT.
SAMPLE/PRELOAD	100	Captures I/O ring contents. Places the boundary scan register between TDI and TDO. Does not affect RAM operation. Does not implement IEEE 1149.1 Preload function. NOT IEEE 1149.1 COMPLIANT.

* Instruction codes expressed in binary, MSB on left, LSB on right.

** Default instruction automatically loaded when TRST asserted or in test-logic-reset state.

STANDARD (PRIVATE) INSTRUCTION CODES

Instruction	Code*	Description
NO OP	000	Do not use these instructions; they are reserved for future use.
NO OP	101	Do not use these instructions; they are reserved for future use.
NO OP	110	Do not use these instructions; they are received for future use.
NO OP	111	Do not use these instructions; they are reserved for future use.

* Instruction codes expressed in binary, MSB on left, LSB on right.

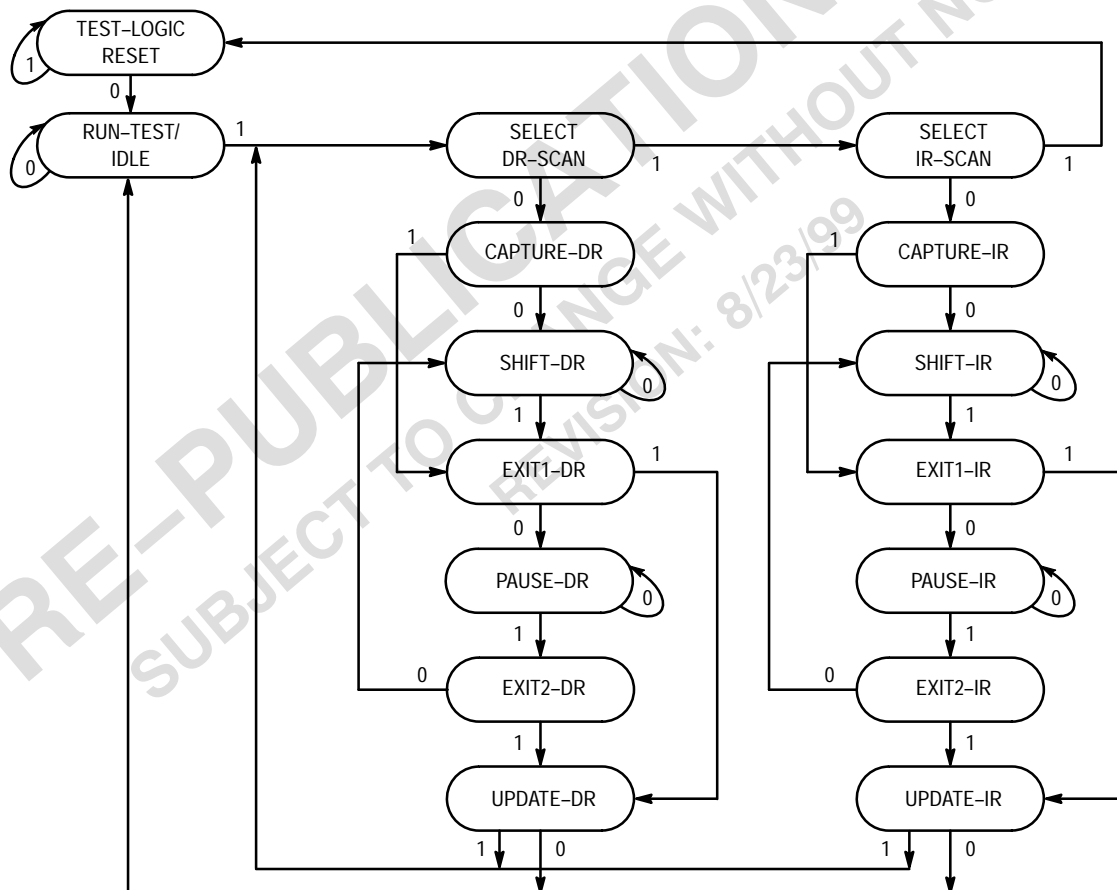

NOTE: The value adjacent to each state transition represents the signal present at TMS at the rising edge of TCK.

Figure 6. TAP Controller State Diagram

Freescale Semiconductor, Inc.

ORDERING INFORMATION (Order by Full Part Number)

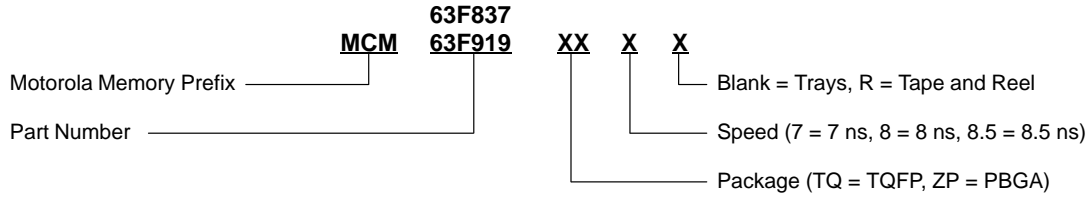

Full Part Numbers —	MCM63F837TQ7	MCM63F837TQ8	MCM63F837TQ8.5
	MCM63F837TQ7R	MCM63F837TQ8R	MCM63F837TQ8.5R
	MCM63F837ZP7	MCM63F837ZP8	MCM63F837ZP8.5
	MCM63F837ZP7R	MCM63F837ZP8R	MCM63F837ZP8.5R
	MCM63F919TQ7	MCM63F919TQ8	MCM63F919TQ8.5
	MCM63F919TQ7R	MCM63F919TQ8R	MCM63F919TQ8.5R
	MCM63F919ZP7	MCM63F919ZP8	MCM63F919ZP8.5
	MCM63F919ZP7R	MCM63F919ZP8R	MCM63F919ZP8.5R

Freescale Semiconductor, Inc.

PRE-PUBLICATION DRAFT

SUBJECT TO CHANGE WITHOUT NOTICE

REVISION: 8/23/99

Freescale Semiconductor, Inc.

PACKAGE DIMENSIONS

TQ PACKAGE
TQFP
CASE 983A-01

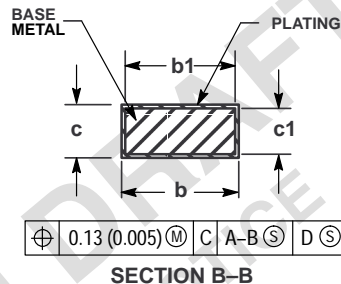
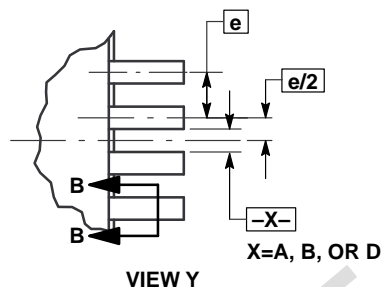
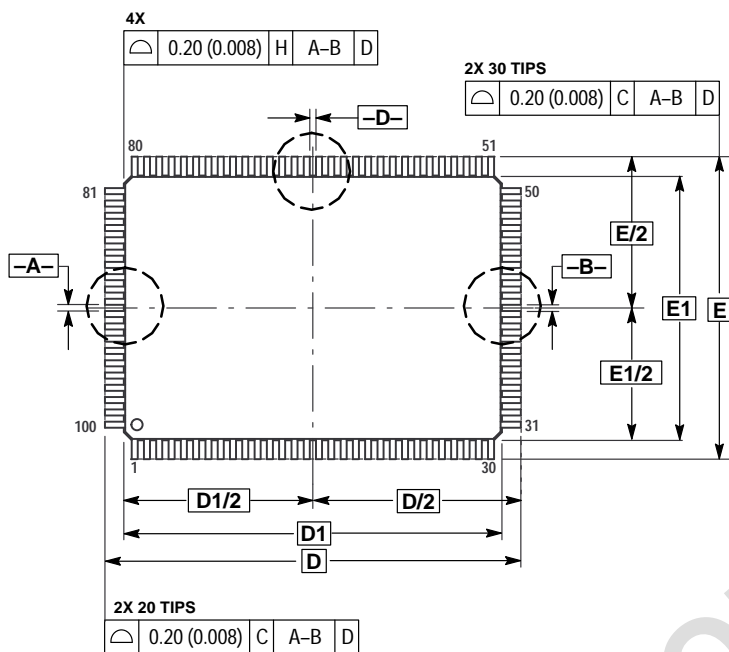

NOTES:

1. DIMENSIONING AND TOLERANCING PER ANSI Y14.5M, 1982.
2. CONTROLLING DIMENSION: MILLIMETER.
3. DATUM PLANE -H- IS LOCATED AT BOTTOM OF LEAD AND IS COINCIDENT WITH THE LEAD WHERE THE LEAD EXITS THE PLASTIC BODY AT THE BOTTOM OF THE PARTING LINE.
4. DATUMS -A-, -B- AND -D- TO BE DETERMINED AT DATUM PLANE -H-.
5. DIMENSIONS D AND E TO BE DETERMINED AT SEATING PLANE -C-.
6. DIMENSIONS D1 AND E1 DO NOT INCLUDE MOLD PROTRUSION. ALLOWABLE PROTRUSION IS 0.25 (0.010) PER SIDE. DIMENSIONS D1 AND B1 DO INCLUDE MOLD MISMATCH AND ARE DETERMINED AT DATUM PLANE -H-.
7. DIMENSION b DOES NOT INCLUDE DAMBAR PROTRUSION. DAMBAR PROTRUSION SHALL NOT CAUSE THE b DIMENSION TO EXCEED 0.45 (0.018).

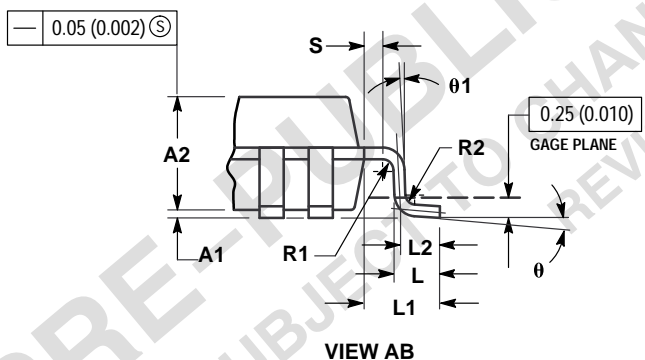
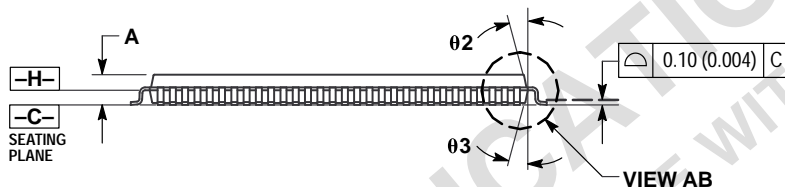

DIM	MILLIMETERS		INCHES	
	MIN	MAX	MIN	MAX
A	---	1.60	---	0.063
A1	0.05	0.15	0.002	0.006
A2	1.35	1.45	0.053	0.057
b	0.22	0.38	0.009	0.015
b1	0.22	0.33	0.009	0.013
c	0.09	0.20	0.004	0.008
c1	0.09	0.16	0.004	0.006
D	22.00 BSC		0.866 BSC	
D1	20.00 BSC		0.787 BSC	
E	16.00 BSC		0.630 BSC	
E1	14.00 BSC		0.551 BSC	
e	0.65 BSC		0.026 BSC	
L	0.45	0.75	0.018	0.030
L1	1.00 REF		0.039 REF	
L2	0.50 REF		0.020 REF	
S	0.20	---	0.008	---
R1	0.08	---	0.003	---
R2	0.08	0.20	0.003	0.008
theta	0°	7°	0°	7°
theta 1	0°	---	0°	---
theta 2	11°	13°	11°	13°
theta 3	11°	13°	11°	13°

Freescale Semiconductor, Inc.

ZP PACKAGE
PBGA
CASE 999-02

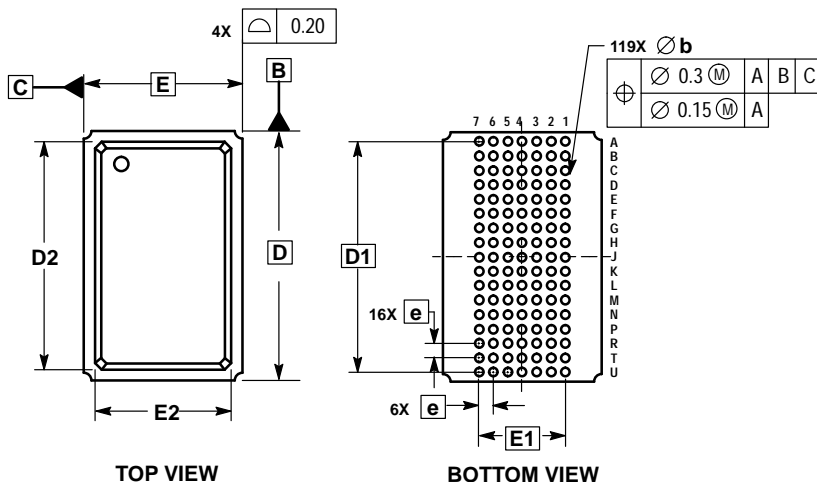

- NOTES:
1. DIMENSIONING AND TOLERANCING PER ASME Y14.5M, 1994.
 2. ALL DIMENSIONS IN MILLIMETERS.
 3. DIMENSION b IS THE MAXIMUM SOLDER BALL DIAMETER MEASURED PARALLEL TO DATUM A.
 4. DATUM A, THE SEATING PLANE, IS DEFINED BY THE SPHERICAL CROWNS OF THE SOLDER BALLS.

DIM	MILLIMETERS	
	MIN	MAX
A	---	2.40
A1	0.50	0.70
A2	1.30	1.70
A3	0.80	1.00
D	22.00 BSC	
D1	20.32 BSC	
D2	19.40	19.60
E	14.00 BSC	
E1	7.62 BSC	
E2	11.90	12.10
b	0.60	0.90
e	1.27 BSC	

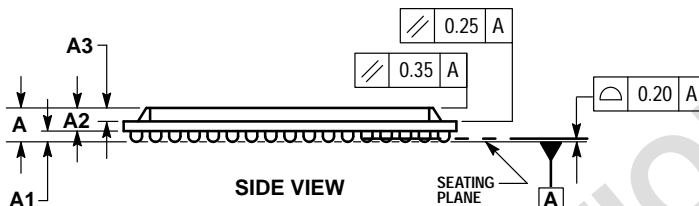

Motorola reserves the right to make changes without further notice to any products herein. Motorola makes no warranty, representation or guarantee regarding the suitability of its products for any particular purpose, nor does Motorola assume any liability arising out of the application or use of any product or circuit, and specifically disclaims any and all liability, including without limitation consequential or incidental damages. "Typical" parameters which may be provided in Motorola data sheets and/or specifications can and do vary in different applications and actual performance may vary over time. All operating parameters, including "Typicals" must be validated for each customer application by customer's technical experts. Motorola does not convey any license under its patent rights nor the rights of others. Motorola products are not designed, intended, or authorized for use as components in systems intended for surgical implant into the body, or other applications intended to support or sustain life, or for any other application in which the failure of the Motorola product could create a situation where personal injury or death may occur. Should Buyer purchase or use Motorola products for any such unintended or unauthorized application, Buyer shall indemnify and hold Motorola and its officers, employees, subsidiaries, affiliates, and distributors harmless against all claims, costs, damages, and expenses, and reasonable attorney fees arising out of, directly or indirectly, any claim of personal injury or death associated with such unintended or unauthorized use, even if such claim alleges that Motorola was negligent regarding the design or manufacture of the part. Motorola and are registered trademarks of Motorola, Inc. Motorola, Inc. is an Equal Opportunity/Affirmative Action Employer.

Mfax is a trademark of Motorola, Inc.

How to reach us:

USA/EUROPE/Locations Not Listed: Motorola Literature Distribution;
P.O. Box 5405, Denver, Colorado, 80217. 1-303-675-2140 or 1-800-441-2447

Mfax™: RMFAX0@email.sps.mot.com – TOUCHTONE 1-602-244-6609
Motorola Fax Back System – US & Canada ONLY 1-800-774-1848
– http://sps.motorola.com/mfax/

HOME PAGE: http://motorola.com/sps/

JAPAN: Motorola Japan Ltd.; SPS, Technical Information Center,
3-20-1, Minami-Azabu, Minato-ku, Tokyo 106-8573 Japan. 81-3-3440-3569

ASIA/PACIFIC: Motorola Semiconductors H.K. Ltd.; Silicon Harbour Centre,
2 Dai King Street, Tai Po Industrial Estate, Tao Po, N.T., Hong Kong.
852-26668334

CUSTOMER FOCUS CENTER: 1-800-521-6274



For More Information On This Product,
Go to: www.freescale.com

MCM63F837/D