



LOW VF SCHOTTKY DIODE MODULE TYPE 600A

Features

High Surge Capability

600Amp Rectifier
45 Volts

Maximum Ratings

Operating Temperature: -40 °C to +100 °C

Storage Temperature: -40 °C to +150 °C

Part Number	Maximum Recurrent Peak Reverse Voltage	Maximum RMS Voltage	Maximum DC Blocking Voltage
MBRA60045CTL	45V	32V	45V

HEAVY TWIN TOWER

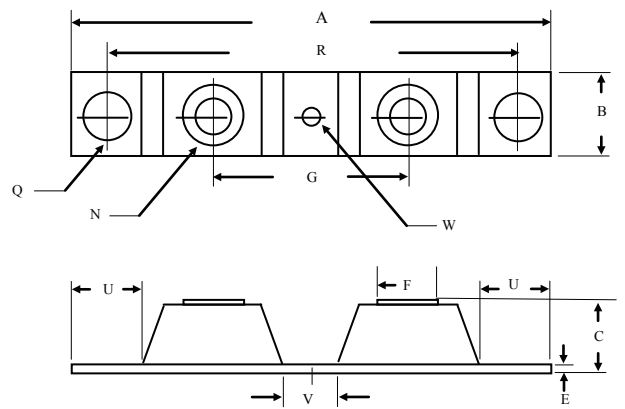

Electrical Characteristics @ 25 °C Unless Otherwise Specified

Average Forward Current (Per pkg)	$I_{F(AV)}$	600A	$T_C=100^{\circ}C$
Peak Forward Surge Current (Per leg)	I_{FSM}	4000A	8.3ms, half sine
Maximum Instantaneous Forward Voltage (Per leg)	V_F	0.60V	$I_{FM}=300A; T_J=25^{\circ}C$
Maximum Instantaneous Reverse Current At Rated DC Blocking Voltage (Per leg)	I_R	5.0mA 350mA	$T_J=25^{\circ}C$ $T_J=100^{\circ}C$
Maximum Thermal Resistance Junction To Case (Per leg)	$R_{\theta jc}$	0.28 °C/W	

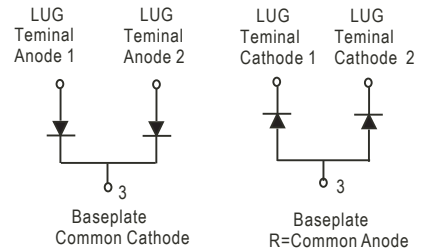

DIM	Inches		Millimeters	
	Min	Max	Min	Max
A	----	3.64	----	92.3
B	1.06	1.067	26.9	27.1
C	----	0.740	----	18.8
E	0.134	0.14	3.4	3.55
F	0.520	0.527	13.2	13.4
G	1.49	BSC	38.0	BSC
N	1/4-20 UNC FULL			
Q	0.275	0.290	6.99	7.37
R	3.150	BSC	80.01	BSC
U	0.512	----	13.0	----
V	0.449	0.472	11.4	12.0
W	0.180	0.195	4.57	4.95

NOTE :

(1) Pulse Test: Pulse Width 300 μ sec. Duty Cycle < 2%



Figure .1-Typical Forward Characteristics

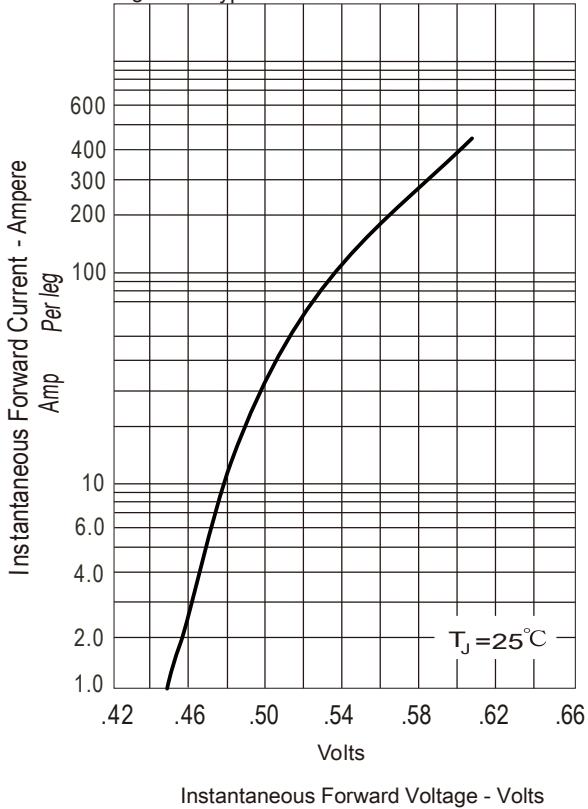

Figure .2- Forward Derating Curve

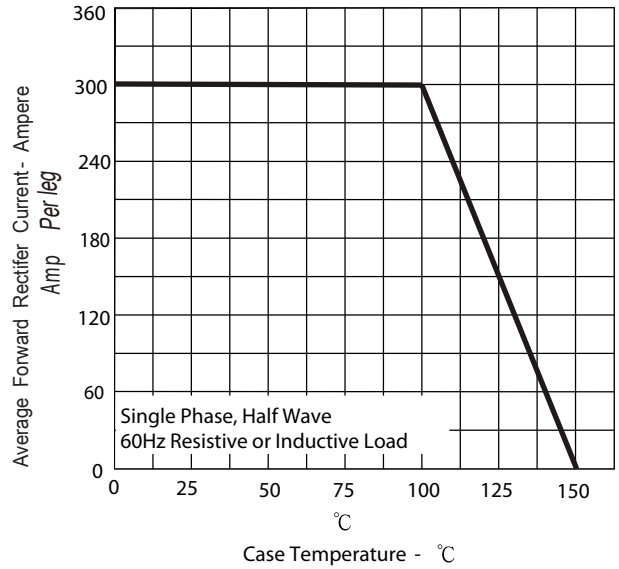

Figure .3- Peak Forward Surge Current

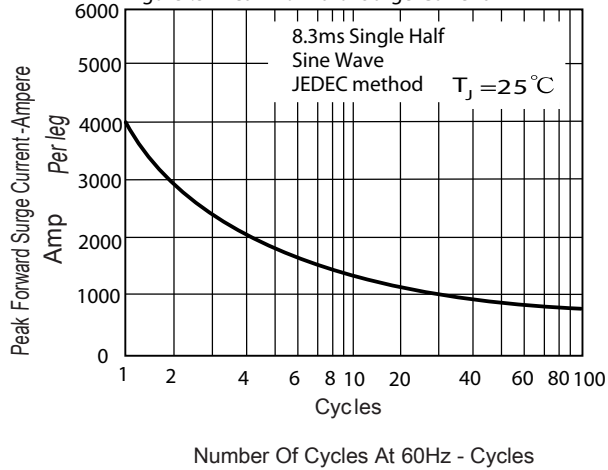

Figure .4-Typical Reverse Characteristics

