

QUAD 2-INPUT NOR LINE DRIVER

KK74128

This device contains four independent 2-input-NOR line drivers. It performs the Boolean function $Y = \overline{A+B}$ or $Y = \overline{A}*\overline{B}$. The **KK74128** is designed to drive 50 ohm lines.

The **KK74128** is characterized for operation from 0C° to 70 °C.

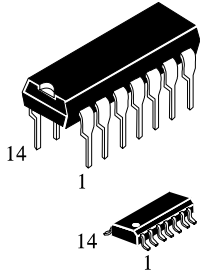

N SUFFIX PLASTIC
D SUFFIX SOIC

ORDERING INFORMATION
 KK74128N Plastic
 KK74128D SOIC
 T_A = -10° to 70° C for all packages

Logic Symbol

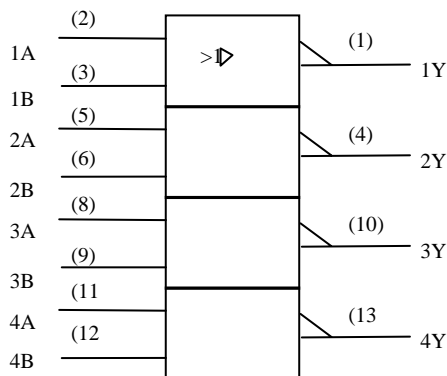

Logic Diagram (Positive Logic)



ABSOLUTE MAXIMUM RATINGS OVER OPERATING FREE-AIR TEMPERATURE RANGE

Supply voltage, V _{cc} (see Note 1)	7 V
Input voltage	5.5 V
Operating free-air temperature range, T _A	0°C to 70°C.
Storage temperature range	-65°C to 150°C

NOTES: 1. Voltage values are with respect to network ground terminal.

RECOMMENDED OPERATING CONDITIONS

		MIN	NOM	MAX	UNIT
V _{CC}	Supply voltage	4.75	5	5.25	V
V _{IH}	High-level input voltage	2			V
V _{IL}	Low-level input voltage			0.8	V
I _{OH}	High-level output current			-42.4	V
I _{OL}	Low-level output current			48	mA
T _A	Operating free-air temperature	0		70	°C

ELECTRICAL CHARACTERISTICS OVER RECOMMENDED OPERATING FREE-AIR TEMPERATURE RANGE

Parameter	Test Conditions*	MIN	TYP**	MAX	UNIT
V _{IK}	V _{CC} = MIN I _I = -12mA			-1.5	V
V _{OH}	V _{CC} = MIN V _{IL} = 0.8V, I _{OH} = -2.4mA	2.4	3.4		V
	V _{CC} = MIN V _{IL} = 0.4V, I _{OH} = -13.2mA	2.4			
	V _{CC} = MIN V _{IL} = 0.4V, I _{OH} = MAX	2			
V _{OL}	V _{CC} = MIN V _{IH} = 2V I _{OL} = 48 mA		0.26	0.4	V
I _I	V _{CC} = MAX V _I = 5.5V			1	m
I _{IH}	V _{CC} = MAX V _I = 2.4V			40	A
I _{IL}	V _{CC} = MAX V _I = 0.4V			-1.6	m
I _{OS} ***	V _{CC} = MAX	-70		-180	mA
I _{CCH}	V _{CC} = MAX		12	21	m
I _{CCL}	V _{CC} = MAX		33	57	mA

*- For conditions shown as MIN or MAX, use the appropriate value specified under recommended operating conditions

** - All typical values are at V_{CC}=5V, T_A=25°C

***-Not more than one output should be shorted at a time.

SWITCHING CHARACTERISTICS, V_{CC} = 5V, T_A = 25°C

Parameter	From (input)	To (output)	Test Conditions	TYP	MAX	UNIT
t _{PLH}	A or B	Y	R _L = 133 C _L = 50 pF	6	9	ns
t _{PHL}				8	12	ns
t _{PLH}			R _L = 133 C _L = 150 pF	10	15	ns
t _{PHL}				12	18	ns

**N SUFFIX PLASTIC DIP
(MS - 001AA)**

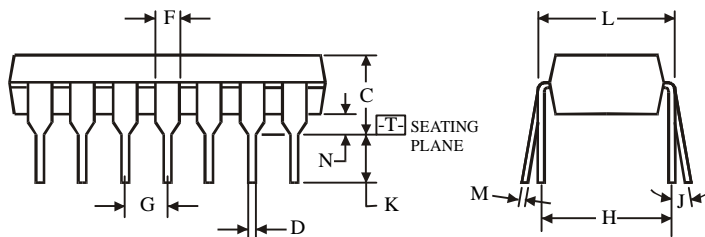
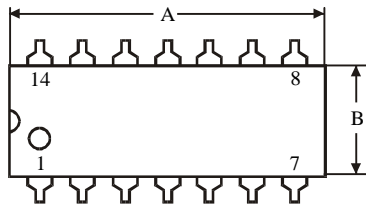
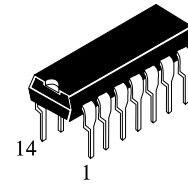

$\oplus 0.25 (0.010) \text{ (M) T}$

NOTES:

- Dimensions "A", "B" do not include mold flash or protrusions.
Maximum mold flash or protrusions 0.25 mm (0.010) per side.

Symbol	Dimension, mm	
	MIN	MAX
A	18.67	19.69
B	6.1	7.11
C		5.33
D	0.36	0.56
F	1.14	1.78
G	2.54	
H	7.62	
J	0°	10°
K	2.92	3.81
L	7.62	8.26
M	0.2	0.36
N	0.38	

**D SUFFIX SOIC
(MS - 012AB)**

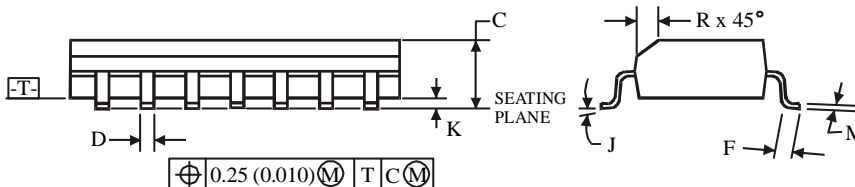
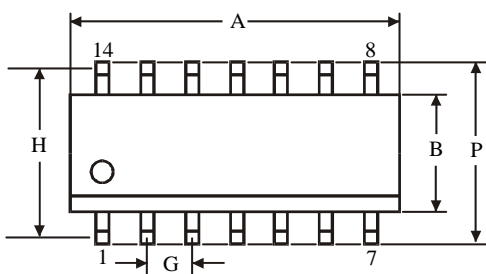
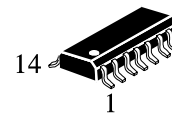

$\oplus 0.25 (0.010) \text{ (M) T C (M)}$

NOTES:

- Dimensions A and B do not include mold flash or protrusion.
- Maximum mold flash or protrusion 0.15 mm (0.006) per side for A; for B - 0.25 mm (0.010) per side.

Symbol	Dimension, mm	
	MIN	MAX
A	8.55	8.75
B	3.8	4
C	1.35	1.75
D	0.33	0.51
F	0.4	1.27
G	1.27	
H	5.27	
J	0°	8°
K	0.1	0.25
M	0.19	0.25
P	5.8	6.2
R	0.25	0.5