

# MC74VHC1G02

## 2-Input NOR Gate

The MC74VHC1G02 is an advanced high speed CMOS 2-input NOR gate fabricated with silicon gate CMOS technology. It achieves high speed operation similar to equivalent Bipolar Schottky TTL while maintaining CMOS low power dissipation.

The internal circuit is composed of three stages, including a buffer output which provides high noise immunity and stable output.

The MC74VHC1G02 input structure provides protection when voltages up to 7V are applied, regardless of the supply voltage. This allows the MC74VHC1G02 to be used to interface 5V circuits to 3V circuits.

- High Speed:  $t_{PD} = 3.0ns$  (Typ) at  $V_{CC} = 5V$
- Low Power Dissipation:  $I_{CC} = 2\mu A$  (Max) at  $T_A = 25^\circ C$
- Power Down Protection Provided on Inputs
- Balanced Propagation Delays
- Pin and Function Compatible with Other Standard Logic Families
- Latchup Performance Exceeds 300mA
- ESD Performance: HBM > 2000V; MM > 200V, CDM > 1500V

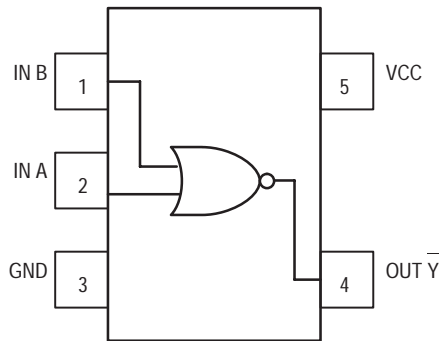
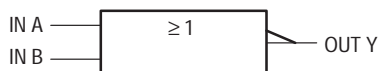

Figure 1. 5-Lead SOT-353 Pinout (Top View)

### LOGIC SYMBOL



**ON Semiconductor**

<http://onsemi.com>

### MARKING DIAGRAMS



**SC-88A / SOT-353/SC-70**  
**DF SUFFIX**  
**CASE 419A**

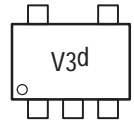

Pin 1  
 d = Date Code

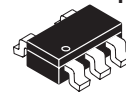

**TSOP-5/SOT-23/SC-59**  
**DT SUFFIX**  
**CASE 483A**

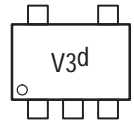

Pin 1  
 d = Date Code

### PIN ASSIGNMENT

PIN ASSIGNMENT	
1	IN B
2	IN A
3	GND
4	OUT Y
5	VCC

### ORDERING INFORMATION

See detailed ordering and shipping information in the package dimensions section on page 4 of this data sheet.

### FUNCTION TABLE

Inputs		Output
A	B	$\bar{Y}$
L	L	H
L	H	L
H	L	L
H	H	L

# MC74VHC1G02

## MAXIMUM RATINGS\*

Characteristics	Symbol	Value	Unit
DC Supply Voltage	$V_{CC}$	-0.5 to +7.0	V
DC Input Voltage	$V_{IN}$	-0.5 to +7.0	V
DC Output Voltage $V_{CC} = 0$ High or Low State	$V_{OUT}$	-0.5 to 7.0 -0.5 to $V_{CC} + 0.5$	V
Input Diode Current	$I_{IK}$	-20	mA
Output Diode Current ( $V_{OUT} < GND$ ; $V_{OUT} > V_{CC}$ )	$I_{OK}$	+20	mA
DC Output Current, per Pin	$I_{OUT}$	+25	mA
DC Supply Current, $V_{CC}$ and GND	$I_{CC}$	+50	mA
Power dissipation in still air, SC-88A †	$P_D$	200	mW
Lead temperature, 1 mm from case for 10 s	$T_L$	260	°C
Storage temperature	$T_{stg}$	-65 to +150	°C

\* Maximum Ratings are those values beyond which damage to the device may occur. Exposure to these conditions or conditions beyond those indicated may adversely affect device reliability. Functional operation under absolute-maximum-rated conditions is not implied. Functional operation should be restricted to the Recommended Operating Conditions.

† Derating — SC-88A Package: -3 mW/°C from 65° to 125°C

## RECOMMENDED OPERATING CONDITIONS

Characteristics	Symbol	Min	Max	Unit
DC Supply Voltage	$V_{CC}$	2.0	5.5	V
DC Input Voltage	$V_{IN}$	0.0	5.5	V
DC Output Voltage	$V_{OUT}$	0.0	$V_{CC}$	V
Operating Temperature Range	$T_A$	-55	+125	°C
Input Rise and Fall Time $V_{CC} = 3.3V \pm 0.3V$ $V_{CC} = 5.0V \pm 0.5V$	$t_r, t_f$	0	100 20	ns/V

The  $\theta_{JA}$  of the package is equal to 1/Derating. Higher junction temperatures may affect the expected lifetime of the device per the table and figure below.

## DEVICE JUNCTION TEMPERATURE VERSUS TIME TO 0.1% BOND FAILURES

Junction Temperature °C	Time, Hours	Time, Years
80	1,032,200	117.8
90	419,300	47.9
100	178,700	20.4
110	79,600	9.4
120	37,000	4.2
130	17,800	2.0
140	8,900	1.0

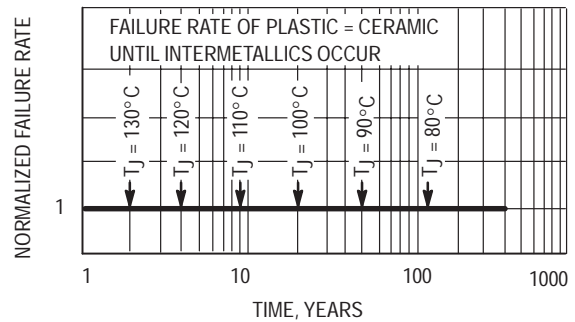

Figure 2. Failure Rate vs. Time Junction Temperature

# MC74VHC1G02

## DC ELECTRICAL CHARACTERISTICS

Symbol	Parameter	Test Conditions	V <sub>CC</sub> (V)	T <sub>A</sub> = 25°C			T <sub>A</sub> ≤ 85°C		T <sub>A</sub> ≤ 125°C		Unit
				Min	Typ	Max	Min	Max	Min	Max	
V <sub>IH</sub>	Minimum High-Level Input Voltage		2.0 3.0 4.5 5.5	1.5 2.1 3.15 3.85			1.5 2.1 3.15 3.85		1.5 2.1 3.15 3.85	V	
V <sub>IL</sub>	Maximum Low-Level Input Voltage		2.0 3.0 4.5 5.5			0.5 0.9 1.35 1.65		0.5 0.9 1.35 1.65		0.5 0.9 1.35 1.65	V
V <sub>OH</sub>	Minimum High-Level Output Voltage V <sub>IN</sub> = V <sub>IH</sub> or V <sub>IL</sub>	V <sub>IN</sub> = V <sub>IH</sub> or V <sub>IL</sub> I <sub>OH</sub> = -50μA	2.0 3.0 4.5	1.9 2.9 4.4	2.0 3.0 4.5		1.9 2.9 4.4		1.9 2.9 4.4	V	
		V <sub>IN</sub> = V <sub>IH</sub> or V <sub>IL</sub> I <sub>OH</sub> = -4mA I <sub>OH</sub> = -8mA	3.0 4.5	2.58 3.94			2.48 3.80		2.34 3.66	V	
V <sub>OL</sub>	Maximum Low-Level Output Voltage V <sub>IN</sub> = V <sub>IH</sub> or V <sub>IL</sub>	V <sub>IN</sub> = V <sub>IH</sub> or V <sub>IL</sub> I <sub>OL</sub> = 50μA	2.0 3.0 4.5		0.0 0.0 0.0	0.1 0.1 0.1		0.1 0.1 0.1		0.1 0.1 0.1	V
		V <sub>IN</sub> = V <sub>IH</sub> or V <sub>IL</sub> I <sub>OL</sub> = 4mA I <sub>OL</sub> = 8mA	3.0 4.5				0.36 0.36		0.44 0.44		0.52 0.52
I <sub>IN</sub>	Maximum Input Leakage Current	V <sub>IN</sub> = 5.5V or GND	0 to 5.5			±0.1		±1.0		±1.0	μA
I <sub>CC</sub>	Maximum Quiescent Supply Current	V <sub>IN</sub> = V <sub>CC</sub> or GND	5.5			2.0		20		40	μA

## AC ELECTRICAL CHARACTERISTICS (C<sub>load</sub> = 50 pF, Input t<sub>r</sub> = t<sub>f</sub> = 3.0ns)

Symbol	Parameter	Test Conditions	T <sub>A</sub> = 25°C			T <sub>A</sub> ≤ 85°C		T <sub>A</sub> ≤ 125°C		Unit
			Min	Typ	Max	Min	Max	Min	Max	
t <sub>PLH</sub> , t <sub>PHL</sub>	Maximum Propagation Delay, Input A or B to Y	V <sub>CC</sub> = 3.0 ± 0.3V C <sub>L</sub> = 15 pF C <sub>L</sub> = 50 pF		4.0 5.4	7.9 11.4		9.5 13.0		11.0 15.5	ns
		V <sub>CC</sub> = 5.0 ± 0.5V C <sub>L</sub> = 15 pF C <sub>L</sub> = 50 pF		3.0 3.8	5.5 7.5		6.5 8.5		8.0 10.0	
C <sub>IN</sub>	Maximum Input Capacitance			5.5	10		10		10	pF

C <sub>PD</sub>	Power Dissipation Capacitance (Note 1.)	Typical @ 25°C, V <sub>CC</sub> = 5.0V		pF
		11		

1. C<sub>PD</sub> is defined as the value of the internal equivalent capacitance which is calculated from the operating current consumption without load. Average operating current can be obtained by the equation: I<sub>CC(OPR)</sub> = C<sub>PD</sub> • V<sub>CC</sub> • f<sub>in</sub> + I<sub>CC</sub>. C<sub>PD</sub> is used to determine the no-load dynamic power consumption; P<sub>D</sub> = C<sub>PD</sub> • V<sub>CC</sub><sup>2</sup> • f<sub>in</sub> + I<sub>CC</sub> • V<sub>CC</sub>.

# MC74VHC1G02

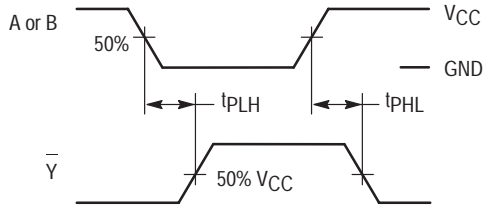
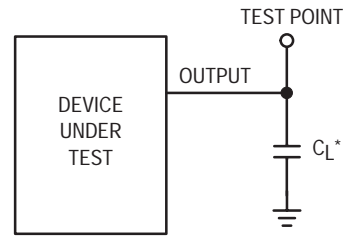

Figure 3. Switching Waveforms



\*Includes all probe and jig capacitance

Figure 4. Test Circuit

## DEVICE ORDERING INFORMATION

Device Order Number	Device Nomenclature						Package Type (Name/SOT#/Common Name)	Tape and Reel Size
	Circuit Indicator	Temp Range Identifier	Technology	Device Function	Package Suffix	Tape & Reel Suffix		
MC74VHC1G02DFT1	MC	74	VHC1G	02	DF	T1	SC-88A / SOT-353 / SC-70	178 mm (7") 3000 Unit
MC74VHC1G02DFT2	MC	74	VHC1G	02	DF	T2	SC-88A / SOT-353 / SC-70	178 mm (7") 3000 Unit
MC74VHC1G02DFR2	MC	74	VHC1G	02	DF	R2	SC-88A / SOT-353 / SC-70	330 mm (13") 10000 Unit
MC74VHC1G02DTT2	MC	74	VHC1G	02	DT	T2	TSOPS / SOT-23 / SC-59	178 mm (7") 3000 Unit
MC74VHC1G02DTR2	MC	74	VHC1G	02	DT	R2	TSOPS / SOT-23 / SC-59	330 mm (13") 10000 Unit

# MC74VHC1G02

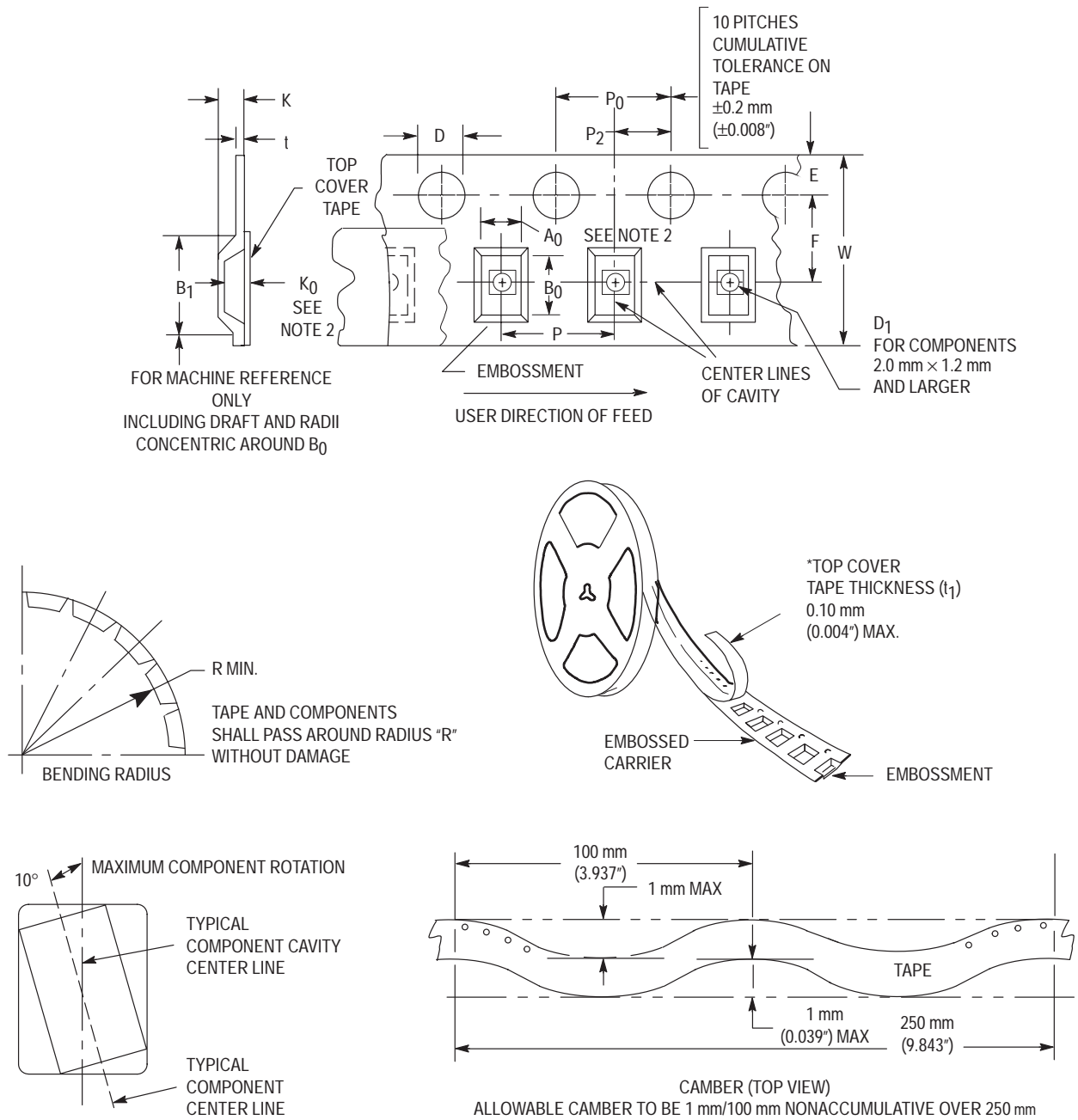

**Figure 5. Carrier Tape Specifications**

**EMBOSSED CARRIER DIMENSIONS** (See Notes 1 and 2)

Tape Size	B <sub>1</sub> Max	D	D <sub>1</sub>	E	F	K	P	P <sub>0</sub>	P <sub>2</sub>	R	T	W
8 mm	4.35 mm (0.171")	1.5 +0.1/-0.0 mm (0.059 +0.004/-0.0")	1.0 mm Min (0.039")	1.75 ±0.1 mm (0.069 ±0.004")	3.5 ±0.5 mm (1.38 ±0.002")	2.4 mm (0.094")	4.0 ±0.10 mm (0.157 ±0.004")	4.0 ±0.1 mm (0.156 ±0.004")	2.0 ±0.1 mm (0.079 ±0.002")	25 mm (0.98")	0.3 ±0.05 mm (0.01 +0.0038/-0.0002")	8.0 ±0.3 mm (0.315 ±0.012")

1. Metric Dimensions Govern—English are in parentheses for reference only.
2. A<sub>0</sub>, B<sub>0</sub>, and K<sub>0</sub> are determined by component size. The clearance between the components and the cavity must be within 0.05 mm min to 0.50 mm max. The component cannot rotate more than 10° within the determined cavity

# MC74VHC1G02

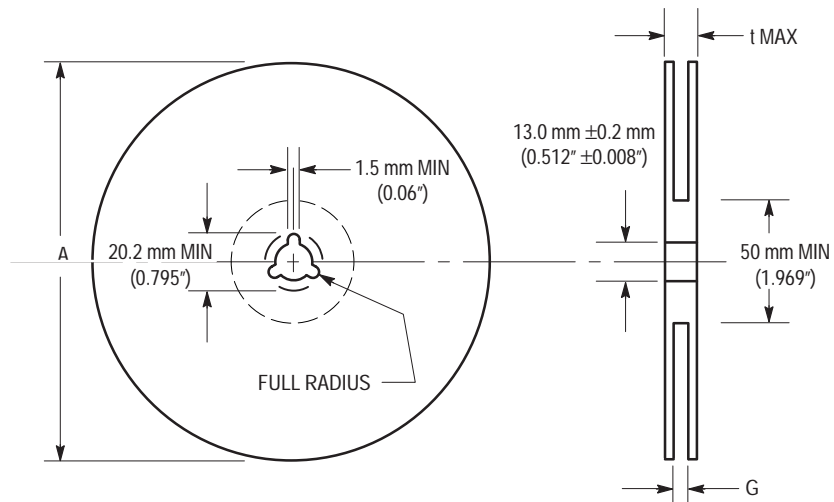

Figure 6. Reel Dimensions

## REEL DIMENSIONS

Tape Size	T&R Suffix	A Max	G	t Max
8 mm	T1, T2	178 mm (7")	8.4 mm, +1.5 mm, -0.0 (0.33" + 0.059", -0.00)	14.4 mm (0.56")
8 mm	R2	330 mm (13")	8.4 mm, +1.5 mm, -0.0 (0.33" + 0.059", -0.00)	14.4 mm (0.56")

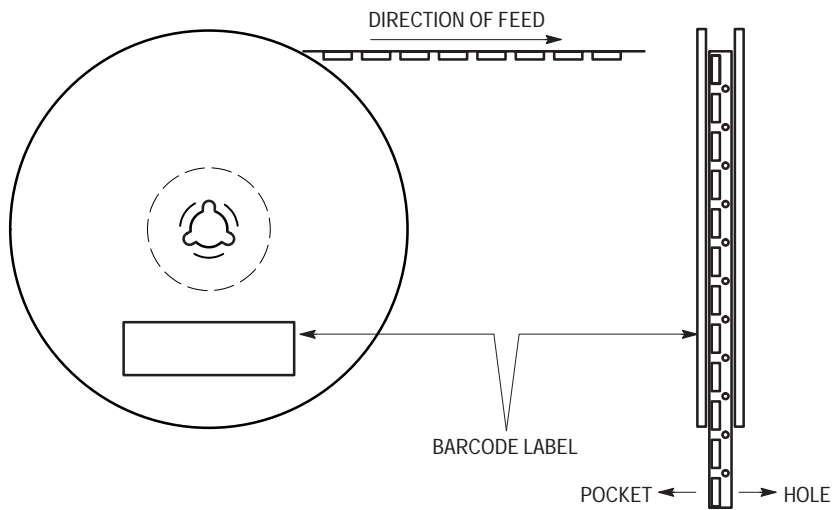
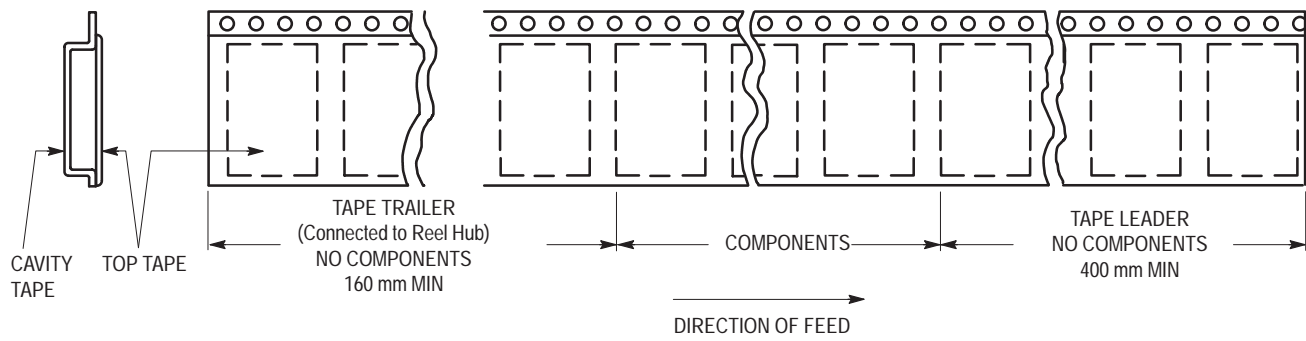
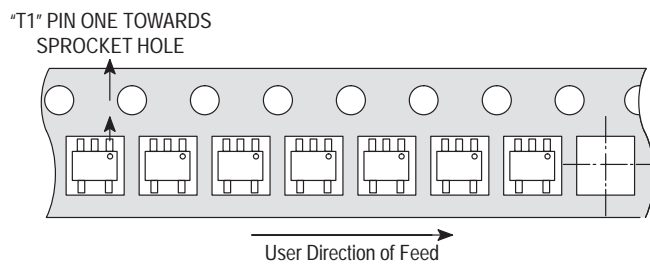

Figure 7. Reel Winding Direction

# MC74VHC1G02



**Figure 8. Tape Ends for Finished Goods**



**Figure 9. T1 Reel Configuration**

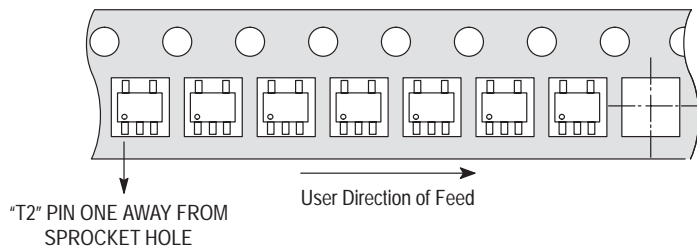

**Figure 10. T2 Reel Configuration**

# MC74VHC1G02

SC-88A / SOT-353 / SC-70  
 DF SUFFIX  
 5-LEAD PACKAGE  
 CASE 419A-01  
 ISSUE B

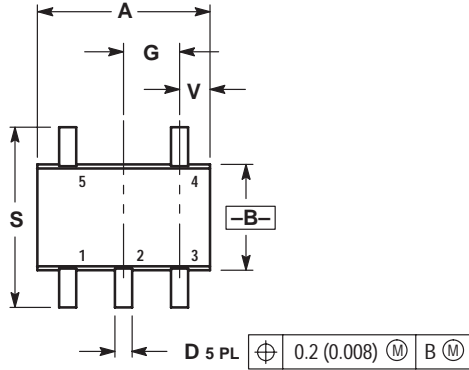

- NOTES:  
 1. DIMENSIONING AND TOLERANCING PER ANSI Y14.5M, 1982.  
 2. CONTROLLING DIMENSION: MM.

DIM	INCHES		MILLIMETERS	
	MIN	MAX	MIN	MAX
A	0.071	0.087	1.80	2.20
B	0.045	0.053	1.15	1.35
C	0.031	0.043	0.80	1.10
D	0.004	0.012	0.10	0.30
G	0.026 BSC		0.65 BSC	
H	---	0.004	---	0.10
J	0.004	0.010	0.10	0.25
K	0.004	0.012	0.10	0.30
N	0.008 REF		0.20 REF	
S	0.079	0.087	2.00	2.20
V	0.012	0.016	0.30	0.40

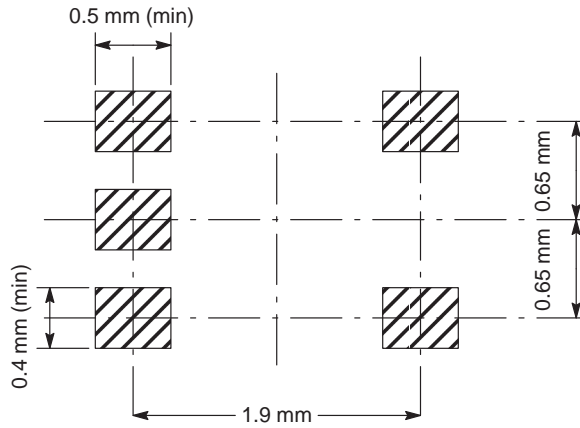
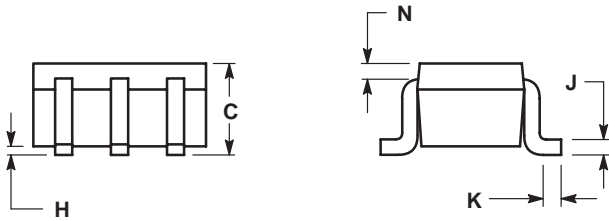



# MC74VHC1G02

TSOP-5 / SOT-23 / SC-59  
 DT SUFFIX  
 5-LEAD PACKAGE  
 CASE 483-01  
 ISSUE A

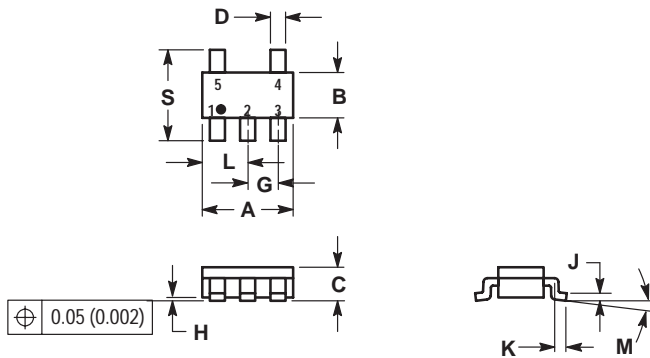

NOTES:

1. DIMENSIONING AND TOLERANCING PER ANSI Y14.5M, 1982.
2. CONTROLLING DIMENSION: MILLIMETER.
3. MAXIMUM LEAD THICKNESS INCLUDES LEAD FINISH THICKNESS. MINIMUM LEAD THICKNESS IS THE MINIMUM THICKNESS OF BASE MATERIAL.

DIM	MILLIMETERS		INCHES	
	MIN	MAX	MIN	MAX
A	2.90	3.10	0.1142	0.1220
B	1.30	1.70	0.0512	0.0669
C	0.90	1.10	0.0354	0.0433
D	0.25	0.50	0.0098	0.0197
G	0.85	1.00	0.0335	0.0413
H	0.013	0.100	0.0005	0.0040
J	0.10	0.26	0.0040	0.0102
K	0.20	0.60	0.0079	0.0236
L	1.25	1.55	0.0493	0.0610
M	0°	10°	0°	10°
S	2.50	3.00	0.0985	0.1181

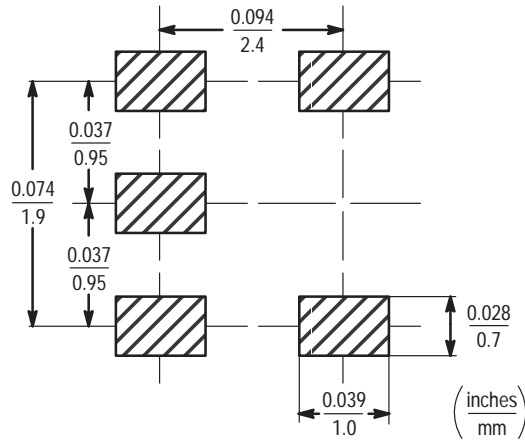

**Notes**

**Notes**

**ON Semiconductor** and  are trademarks of Semiconductor Components Industries, LLC (SCILLC). SCILLC reserves the right to make changes without further notice to any products herein. SCILLC makes no warranty, representation or guarantee regarding the suitability of its products for any particular purpose, nor does SCILLC assume any liability arising out of the application or use of any product or circuit, and specifically disclaims any and all liability, including without limitation special, consequential or incidental damages. "Typical" parameters which may be provided in SCILLC data sheets and/or specifications can and do vary in different applications and actual performance may vary over time. All operating parameters, including "Typicals" must be validated for each customer application by customer's technical experts. SCILLC does not convey any license under its patent rights nor the rights of others. SCILLC products are not designed, intended, or authorized for use as components in systems intended for surgical implant into the body, or other applications intended to support or sustain life, or for any other application in which the failure of the SCILLC product could create a situation where personal injury or death may occur. Should Buyer purchase or use SCILLC products for any such unintended or unauthorized application, Buyer shall indemnify and hold SCILLC and its officers, employees, subsidiaries, affiliates, and distributors harmless against all claims, costs, damages, and expenses, and reasonable attorney fees arising out of, directly or indirectly, any claim of personal injury or death associated with such unintended or unauthorized use, even if such claim alleges that SCILLC was negligent regarding the design or manufacture of the part. SCILLC is an Equal Opportunity/Affirmative Action Employer.

## PUBLICATION ORDERING INFORMATION

### **NORTH AMERICA Literature Fulfillment:**

Literature Distribution Center for ON Semiconductor  
P.O. Box 5163, Denver, Colorado 80217 USA  
**Phone:** 303-675-2175 or 800-344-3860 Toll Free USA/Canada  
**Fax:** 303-675-2176 or 800-344-3867 Toll Free USA/Canada  
**Email:** ONlit@hibbertco.com  
Fax Response Line: 303-675-2167 or 800-344-3810 Toll Free USA/Canada

**N. American Technical Support:** 800-282-9855 Toll Free USA/Canada

**EUROPE:** LDC for ON Semiconductor – European Support

**German Phone:** (+1) 303-308-7140 (M-F 1:00pm to 5:00pm Munich Time)  
**Email:** ONlit-german@hibbertco.com  
**French Phone:** (+1) 303-308-7141 (M-F 1:00pm to 5:00pm Toulouse Time)  
**Email:** ONlit-french@hibbertco.com  
**English Phone:** (+1) 303-308-7142 (M-F 12:00pm to 5:00pm UK Time)  
**Email:** ONlit@hibbertco.com

**EUROPEAN TOLL-FREE ACCESS\*: 00-800-4422-3781**

\*Available from Germany, France, Italy, England, Ireland

### **CENTRAL/SOUTH AMERICA:**

**Spanish Phone:** 303-308-7143 (Mon-Fri 8:00am to 5:00pm MST)  
**Email:** ONlit-spanish@hibbertco.com

**ASIA/PACIFIC:** LDC for ON Semiconductor – Asia Support

**Phone:** 303-675-2121 (Tue-Fri 9:00am to 1:00pm, Hong Kong Time)  
Toll Free from Hong Kong & Singapore:  
**001-800-4422-3781**  
**Email:** ONlit-asia@hibbertco.com

**JAPAN:** ON Semiconductor, Japan Customer Focus Center  
4-32-1 Nishi-Gotanda, Shinagawa-ku, Tokyo, Japan 141-0031  
**Phone:** 81-3-5740-2745  
**Email:** r14525@onsemi.com

**ON Semiconductor Website:** <http://onsemi.com>

For additional information, please contact your local Sales Representative.