

3.96mm(.156") Pitch Housing

YAL E182481

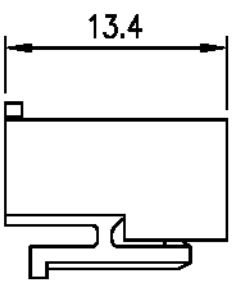
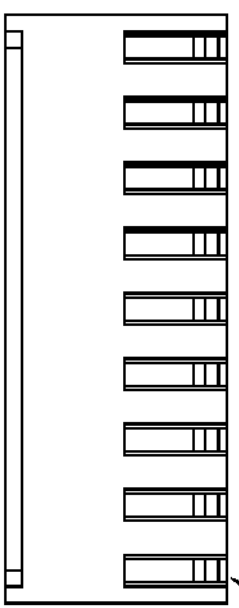
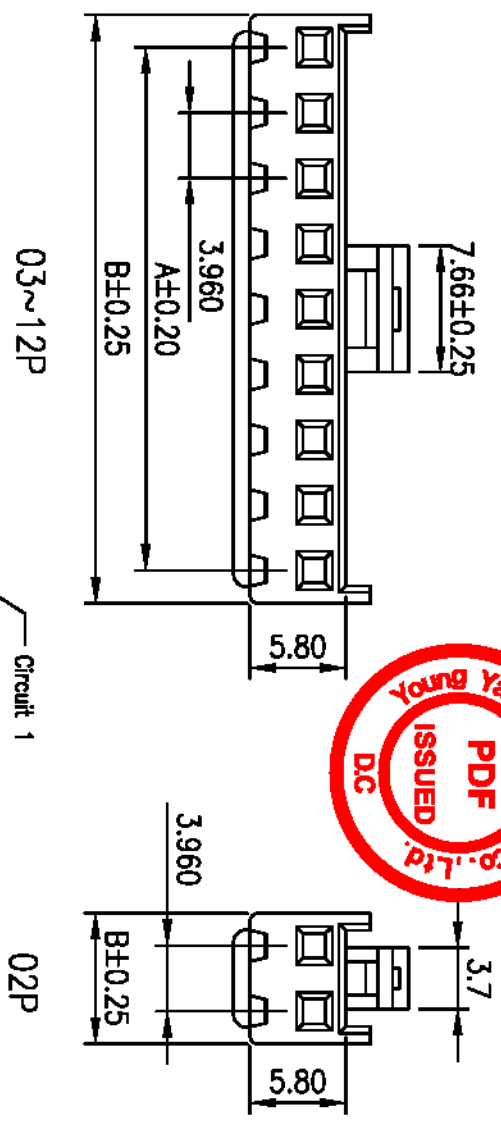
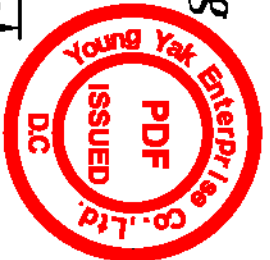

Ordering Information:

YY-2800-HXX-X

PIN:02~12

- :Nature
- A:Black
- B:Brown
- C:Red
- D:Orange
- E:Yellow
- F:Green
- G:Blue
- H:Purple
- I:Gray
- J:White
- K:Pink

Specification:

- * Pitch between poles 3.96mm
- * Rated Voltage 250V AC/DC
- * Rated Current 5A AC/DC
- * Withstand Voltage 1,500V AC/minute
- * Insulation Resistance 1,000M ohms/minute
- * Temperature Range -25C~85C

Circuits	Part No	Dimension mm	
		A	B
2	YY-2800-H02	3.96	8.12
3	YY-2800-H03	7.92	12.08
4	YY-2800-H04	11.88	16.04
5	YY-2800-H05	15.84	20.00
6	YY-2800-H06	19.80	23.96
7	YY-2800-H07	23.76	27.82
8	YY-2800-H08	27.72	31.88
9	YY-2800-H09	31.68	35.84
10	YY-2800-H10	35.64	39.80
11	YY-2800-H11	39.60	43.76
12	YY-2800-H12	43.56	47.72

Features:

- * Available in 2 through 12 Circuits
- * Material: Nylon 66 UL94V-0
- * Accepts YY-2800-T Crimp Terminal
- * Mates with YY-2800-WXXS or YY-2800-WXXR Series Wafers

EDITION	DATE	MODIFY	VIEW	DRAW BY	AUDITING	APPROVAL	DATE	DWG NO	TOLERANCE
A1	2003.05.29	CHANGE		GUAN	ALVIN	Jessica	2004.10.29	YY-2800-HXX-X	.0
A2	2003.06.24	CHANGE							±0.15
A3	2004.10.29	CHANGE							±0.10

YAL 毅耀實業股份有限公司
YOUNG YAK ENTERPRISE CO.,LTD.

TEL:886-2-2999-9629
FAX:886-2-2999-0575

A396SH
014-A3

RoHS compliant

3.96mm (.156") Pitch Wafer

YA E182481

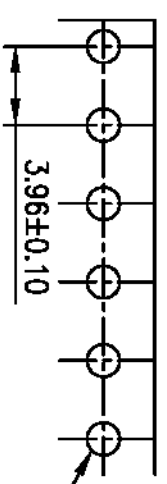
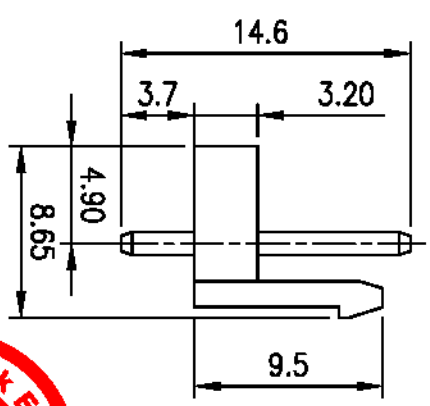
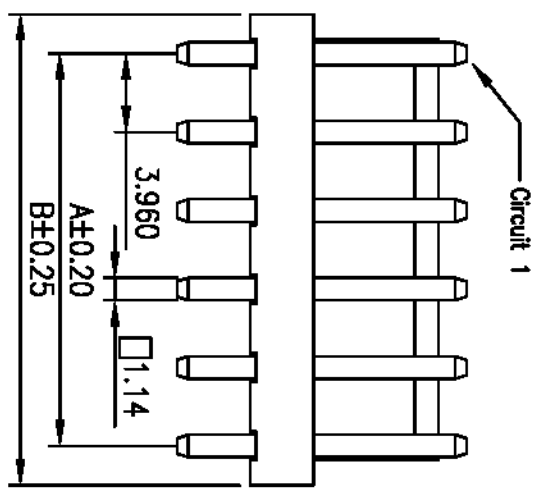
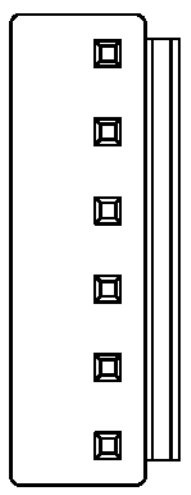

P.C.B LAYOUT

P.C.B Hole dia $\phi 1.65\text{mm} \pm 0.10$
P.C.B Thickness 0.80~1.60mm



Ordering information:

YY-2800-WXXSX



Features:

- * Available in 2 through 15 Circuits
- * Housing Material: Nylon 66 UL94-V0
- * Mates with YY-2800-HXX Series Housing
- * 1.14mm(.045") Square Pin
- * Pin Material: Brass/Tin-Plated

Specifications:

- * Pitch Between Poles 3.96mm
- * Rated Voltage 250V AC,DC
- * Rated Current 5A
- * Withstand Voltage 1,500V AC/minute
- * Insulation Resistance 1,000M ohms /min
- * Temperature Range -25°C~+85°C

Circuits	Part No	Dimension mm	
		A	B
2	YY-2800-W02S	3.96	7.92
3	YY-2800-W03S	7.92	11.88
4	YY-2800-W04S	11.88	15.84
5	YY-2800-W05S	15.84	19.80
6	YY-2800-W06S	19.80	23.76
7	YY-2800-W07S	23.76	27.72
8	YY-2800-W08S	27.72	31.68
9	YY-2800-W09S	31.68	35.64
10	YY-2800-W10S	35.64	39.60
11	YY-2800-W11S	39.60	43.56
12	YY-2800-W12S	43.56	47.52
13	YY-2800-W13S	47.52	51.48
14	YY-2800-W14S	51.45	55.44
15	YY-2800-W15S	55.44	59.40

EDITION	DATE	MODIFY	VIEW	DRAW BY	AUDITING	APPROVAL	DATE	DWG NO	TOLERANCE
A0	2003.02.15	DRAWING		GUAN	ALVIN	Jessica	2004.10.29	YY-2800-WXXSX	.00
A1	2004.10.29	CHANGE							±0.15
									±0.08

YOUNG YAK ENTERPRISE CO.,LTD.
TEL:886-2-2999-9629
FAX:886-2-2999-0575

3.96mm (.156") Pitch Wafer

YA E182481

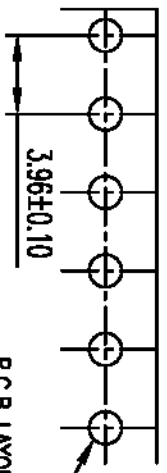
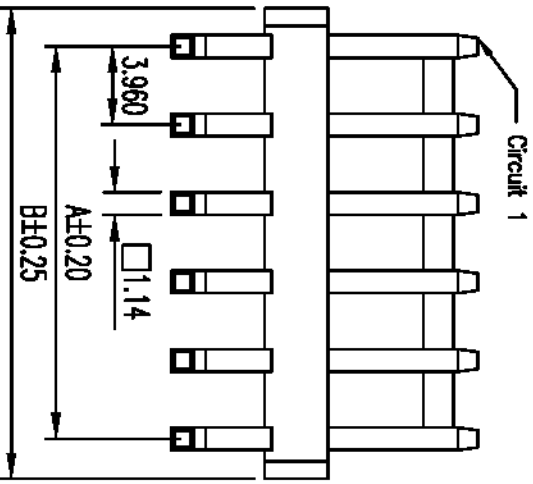
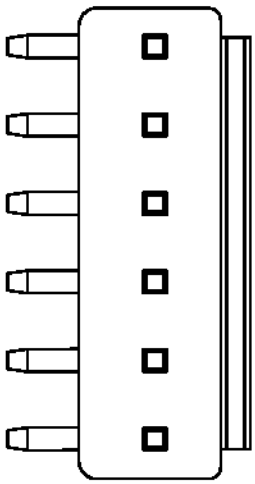

Ordering information:

YY-2800-WXXRX

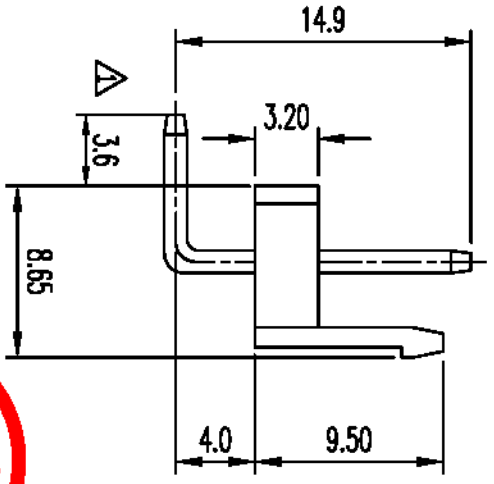
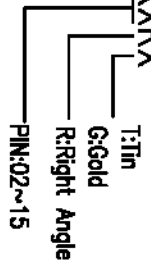

Features:

- * Available in 2 through 15 Circuits
- * Housing Material: Nylon 66 UL94-V0
- * Mates with YY-2800-HXX Series Housing
- * 1.14mm(.045") Square Pin
- * Pin Material: Brass/Tin-Plated

Specifications:

- * Pitch Between Poles: 3.96mm
- * Rated Voltage: 250V AC,DC
- * Rated Current: 5A
- * Withstand Voltage: 1,500V AC/minute
- * Insulation Resistance: 1,000M ohms /min
- * Temperature Range: -25~+85C



Circuits	Part No	Dimension mm	
		A	B
2	YY-2800-W02R	3.96	7.92
3	YY-2800-W03R	7.92	11.88
4	YY-2800-W04R	11.88	15.84
5	YY-2800-W05R	15.84	19.80
6	YY-2800-W06R	19.80	23.76
7	YY-2800-W07R	23.76	27.72
8	YY-2800-W08R	27.72	31.68
9	YY-2800-W09R	31.68	35.64
10	YY-2800-W10R	35.64	39.60
11	YY-2800-W11R	39.60	43.56
12	YY-2800-W12R	43.56	47.52
13	YY-2800-W13R	47.52	51.48
14	YY-2800-W14R	51.45	55.44
15	YY-2800-W15R	55.44	59.40

EDITION	DATE	MODIFY	VIEW	DRAW BY	AUDITING	APPROVAL	DATE	DWG NO	TOLERANCE
A0	2003.02.15	DRAWING		GUAN	ALVIN	Jessica	2004.10.29	YY-2800-WXXRX	0
A1	2004.01.08	ADD SIZE							±0.15
A2	2004.10.29	CHANGE							±0.10

Young Yak Enterprises Co., Ltd.
 毅耀實業股份有限公司
 YOUNG YAK ENTERPRISE CO.,LTD.
 TEL:886-2-2999-9629
 FAX:886-2-2999-0575

3.96mm (.156") Pitch Crimp Terminal

YJ E182481

Features:

- * Used in YY-2800-1HXX Series Housing
- * Accepts AWG 18~22 Wire Range
- * Insulation O.D.= 2.80 mm(max)
- * Material : Brass
- * Finish : Tin-Plated
- * Qty/Reel : 4,000 PCS
- * Thickness: 0.25mm

Specification:

- * Pitch Between Poles 3.96mm
- * Rated Voltage 250V AC,DC
- * Rated Current 5A
- * Withstand Voltage 1,500V AC/minute
- * Insulation Resistance 1,000M Ohms/Min
- * Temperature Range -25°C~+85°C



Ordering Information:

YY-2800-TXXX

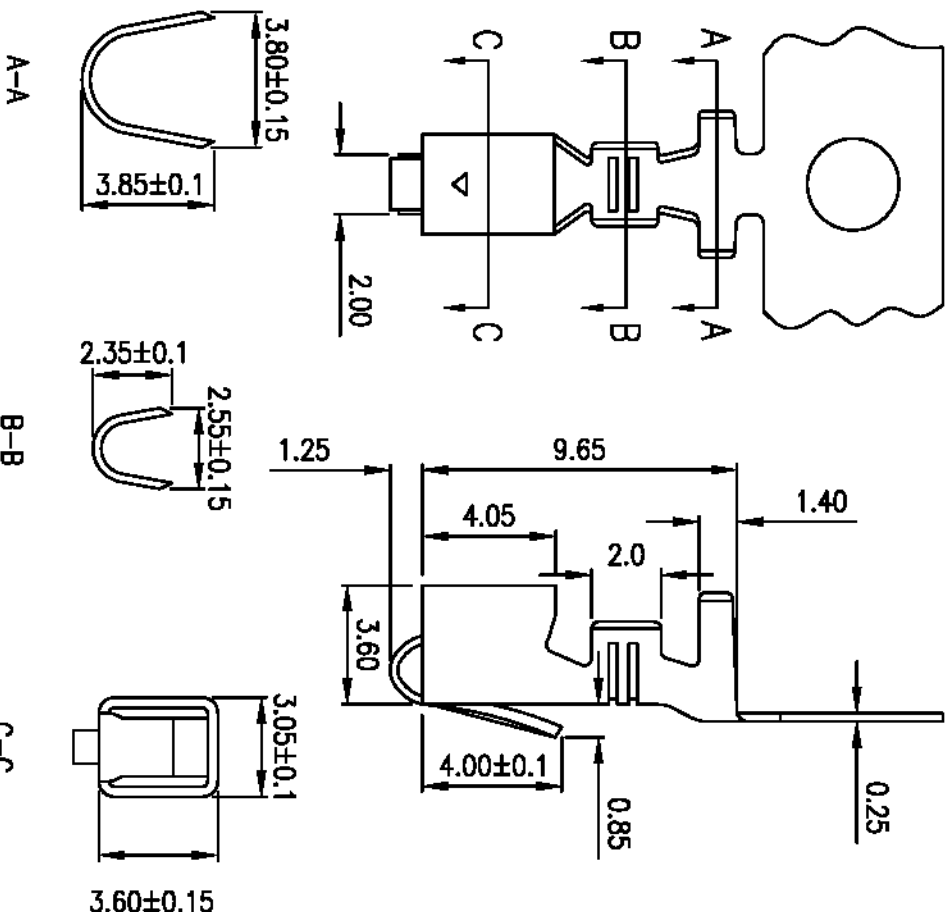
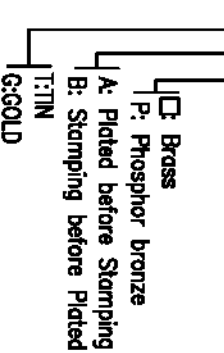

EDITION	DATE	MODIFY	VIEW	DRAW BY	AUDITING	APPROVAL	DATE	DWG NO	TOLERANCE
A0	2004.05.20	DRAWING		ART	Jeff	Jessica	2004.05.20	A3963T 125-A0	.0 ±0.25
								YY-2800-TXXX	.00 ±0.15
									.000 ±0.05

YOUNG YAK ENTERPRISE CO.,LTD.
 毅耀實業股份有限公司
 TEL:886-2-2999-9629
 FAX:886-2-2999-0575