

# General Purpose Transistors

## PNP Silicon

- Moisture Sensitivity Level: 1
- ESD Rating – Human Body Model: >4000 V  
– Machine Model: >400 V
- We declare that the material of product compliance with RoHS requirements.
- S- Prefix for Automotive and Other Applications Requiring Unique Site and Control Change Requirements; AEC-Q101 Qualified and PPAP Capable.

### MAXIMUM RATINGS (T<sub>A</sub> = 25°C unless otherwise noted)

Rating	Symbol	Value	Unit
Collector-Emitter Voltage LBC856 LBC857 LBC858, LBC859	V <sub>CEO</sub>	-65 -45 -30	V
Collector-Base Voltage LBC856 LBC857 LBC858, LBC859	V <sub>CBO</sub>	-80 -50 -30	V
Emitter-Base Voltage	V <sub>EBO</sub>	-5.0	V
Collector Current – Continuous	I <sub>C</sub>	-100	mAdc

### THERMAL CHARACTERISTICS

Characteristic	Symbol	Max	Unit
Total Device Dissipation FR-5 Board, (Note 1.) T <sub>A</sub> = 25°C Derate above 25°C	P <sub>D</sub>	225 1.8	mW mW/°C
Thermal Resistance, Junction to Ambient	R <sub>θJA</sub>	556	°C/W
Total Device Dissipation Alumina Substrate, (Note 2.) T <sub>A</sub> = 25°C Derate above 25°C	P <sub>D</sub>	300 2.4	mW mW/°C
Thermal Resistance, Junction to Ambient	R <sub>θJA</sub>	417	°C/W
Junction and Storage Temperature	T <sub>J</sub> , T <sub>stg</sub>	-55 to +150	°C

1. FR-5 = 1.0 x 0.75 x 0.062 in
2. Alumina = 0.4 x 0.3 x 0.024 in. 99.5% alumina.

**LBC857CLT1G  
Series  
S-LBC857CLT1G  
Series**

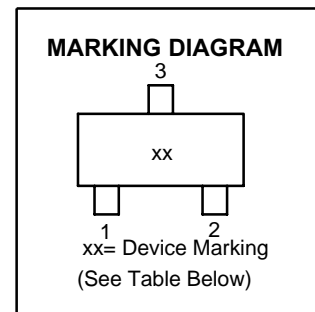
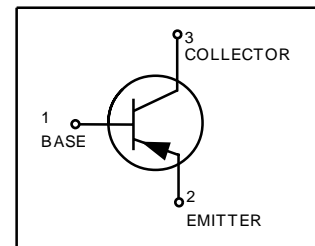
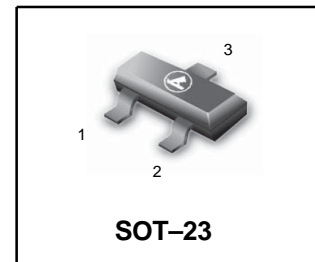

**LBC857CLT1G Series , S-LBC857CLT1G Series****DEVICE MARKING AND ORDERING INFORMATION**

Device	Marking	Package	Shipping
(S-)LBC856ALT1G	3A	SOT-23	3000/Tape&Reel
(S-)LBC856ALT3G	3A	SOT-23	10000/Tape&Reel
(S-)LBC856BLT1G	3B	SOT-23	3000/Tape&Reel
(S-)LBC856BLT3G	3B	SOT-23	10000/Tape&Reel
(S-)LBC857ALT1G	3E	SOT-23	3000/Tape&Reel
(S-)LBC857ALT1G	3E	SOT-23	10000/Tape&Reel
(S-)LBC857BLT1G	3F	SOT-23	3000/Tape&Reel
(S-)LBC857BLT3G	3F	SOT-23	10000/Tape&Reel
(S-)LBC857CLT1G	3G	SOT-23	3000/Tape&Reel
(S-)LBC857CLT1G	3G	SOT-23	10000/Tape&Reel
(S-)LBC858ALT1G	3J	SOT-23	3000/Tape&Reel
(S-)LBC858ALT1G	3J	SOT-23	10000/Tape&Reel
(S-)LBC858BLT1G	3K	SOT-23	3000/Tape&Reel
(S-)LBC858BLT3G	3K	SOT-23	10000/Tape&Reel
(S-)LBC858CLT1G	3L	SOT-23	3000/Tape&Reel
(S-)LBC858CLT3G	3L	SOT-23	10000/Tape&Reel
(S-)LBC859BLT1G	4B	SOT-23	3000/Tape&Reel
(S-)LBC859BLT1G	4B	SOT-23	10000/Tape&Reel
(S-)LBC859CLT1G	4C	SOT-23	3000/Tape&Reel
(S-)LBC859CLT3G	4C	SOT-23	10000/Tape&Reel

## LBC857CLT1G Series , S-LBC857CLT1G Series

### ELECTRICAL CHARACTERISTICS (T<sub>A</sub> = 25°C unless otherwise noted)

Characteristic	Symbol	Min	Typ	Max	Unit	
<b>OFF CHARACTERISTICS</b>						
Collector–Emitter Breakdown Voltage (I <sub>C</sub> = –10 mA)	LBC856 Series LBC857 Series LBC858, LBC859 Series	V <sub>(BR)CEO</sub>	–65 –45 –30	–	–	V
Collector–Emitter Breakdown Voltage (I <sub>C</sub> = –10 μA, V <sub>EB</sub> = 0)	LBC856 Series LBC857 Series LBC858, LBC859 Series	V <sub>(BR)CES</sub>	–80 –50 –30	–	–	V
Collector–Base Breakdown Voltage (I <sub>C</sub> = –10 μA)	LBC856 Series LBC857 Series LBC858, LBC859 Series	V <sub>(BR)CBO</sub>	–80 –50 –30	–	–	V
Emitter–Base Breakdown Voltage (I <sub>E</sub> = –1.0 μA)	LBC856 Series LBC857 Series LBC858, LBC859 Series	V <sub>(BR)EBO</sub>	–5.0 –5.0 –5.0	–	–	V
Collector Cutoff Current (V <sub>CB</sub> = –30 V) (V <sub>CB</sub> = –30 V, T <sub>A</sub> = 150°C)		I <sub>CBO</sub>	– –	–	–15 –4.0	nA μA
<b>ON CHARACTERISTICS</b>						
DC Current Gain (I <sub>C</sub> = –2.0 mA, V <sub>CE</sub> = –5.0 V)	LBC856A, LBC857A, LBC858A LBC856B, LBC857B, LBC858B, LBC859B LBC857C, LBC858C, LBC859C	h <sub>FE</sub>	125 220 420	180 290 520	250 475 800	–
Collector–Emitter Saturation Voltage (I <sub>C</sub> = –10 mA, I <sub>B</sub> = –0.5 mA) (I <sub>C</sub> = –100 mA, I <sub>B</sub> = –5.0 mA)		V <sub>CE(sat)</sub>	– –	–	–0.3 –0.65	V
Base–Emitter Saturation Voltage (I <sub>C</sub> = –10 mA, I <sub>B</sub> = –0.5 mA) (I <sub>C</sub> = –100 mA, I <sub>B</sub> = –5.0 mA)		V <sub>BE(sat)</sub>	– –	–0.7 –0.9	–	V
Base–Emitter On Voltage (I <sub>C</sub> = –2.0 mA, V <sub>CE</sub> = –5.0 V) (I <sub>C</sub> = –10 mA, V <sub>CE</sub> = –5.0 V)		V <sub>BE(on)</sub>	–0.6 –	–	–0.75 –0.82	V
<b>SMALL–SIGNAL CHARACTERISTICS</b>						
Current–Gain – Bandwidth Product (I <sub>C</sub> = –10 mA, V <sub>CE</sub> = –5.0 Vdc, f = 100 MHz)		f <sub>T</sub>	100	–	–	MHz
Output Capacitance (V <sub>CB</sub> = –10 V, f = 1.0 MHz)		C <sub>ob</sub>	–	–	4.5	pF
Noise Figure (I <sub>C</sub> = –0.2 mA, V <sub>CE</sub> = –5.0 Vdc, R <sub>S</sub> = 2.0 kΩ, f = 1.0 kHz, BW = 200 Hz)	LBC856, LBC857, LBC858 Series LBC859 Series	NF	– –	–	10 4.0	dB

## LBC857CLT1G Series , S-LBC857CLT1G Series

### LBC857/ LBC858

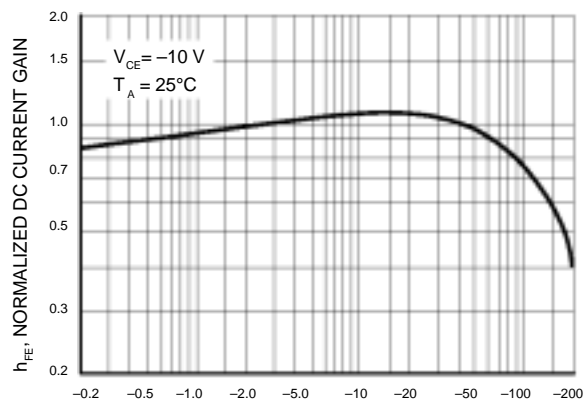

$I_C$ , COLLECTOR CURRENT (mAdc)  
Figure 1. Normalized DC Current Gain

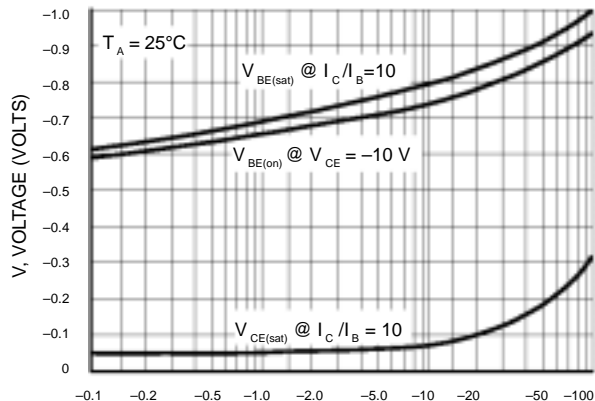

$I_C$ , COLLECTOR CURRENT (mAdc)  
Figure 2. "Saturation" and "On" Voltages

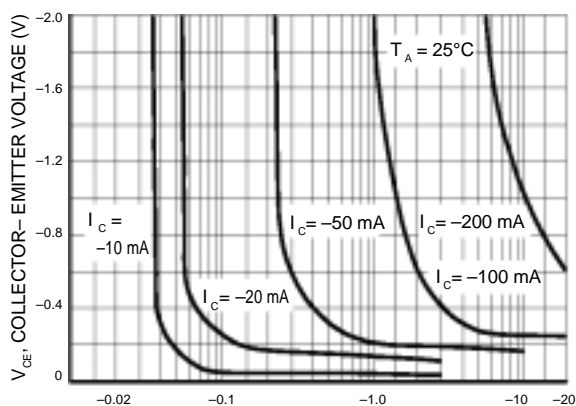

$I_B$ , BASE CURRENT (mA)  
Figure 3. Collector Saturation Region

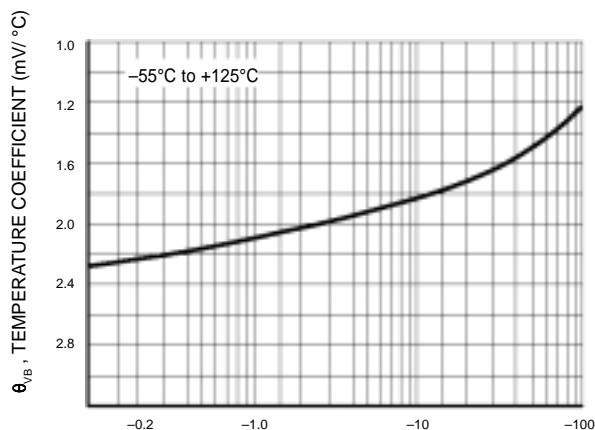

$I_C$ , COLLECTOR CURRENT (mA)  
Figure 4. Base-Emitter Temperature Coefficient

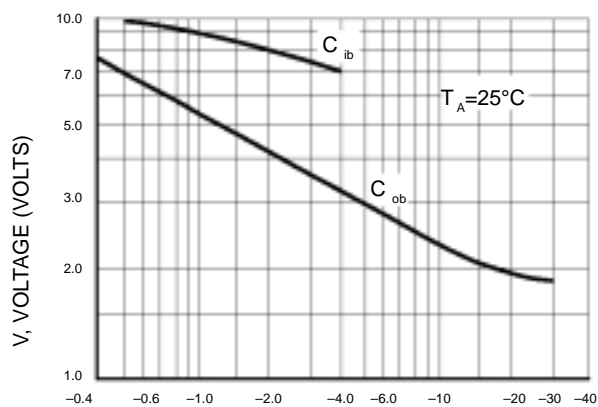

$V_R$ , REVERSE VOLTAGE (VOLTS)  
Figure 5. Capacitances

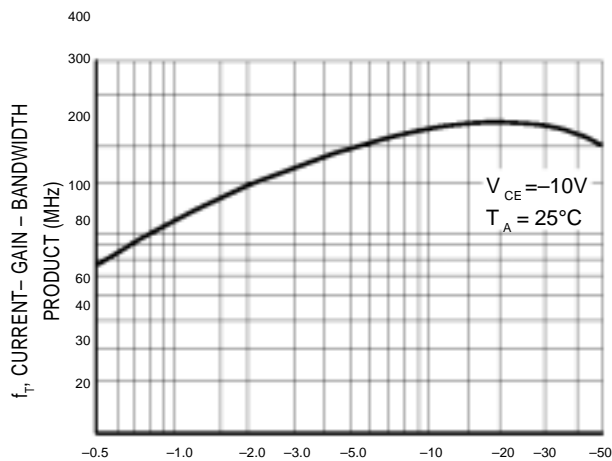

$I_C$ , COLLECTOR CURRENT (mAdc)  
Figure 6. Current-Gain - Bandwidth Product

## LBC857CLT1G Series , S-LBC857CLT1G Series

### LBC856

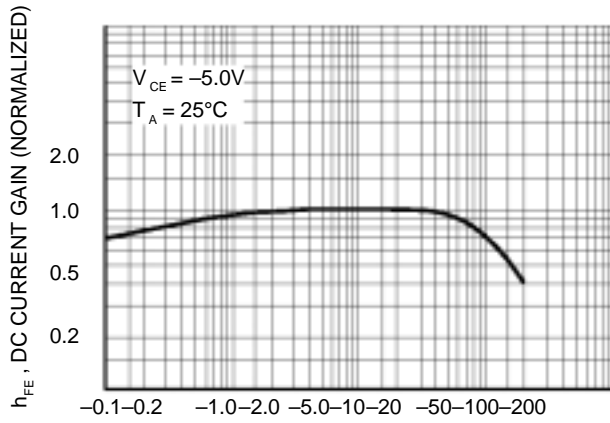

$I_C$ , COLLECTOR CURRENT (mA)  
Figure 7. DC Current Gain

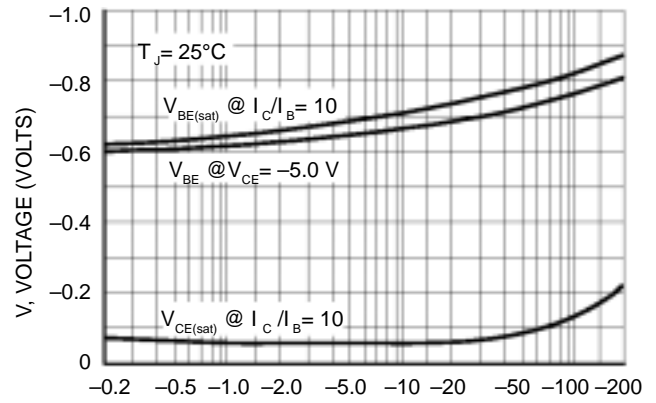

$I_C$ , COLLECTOR CURRENT (mA)  
Figure 8. "On" Voltage

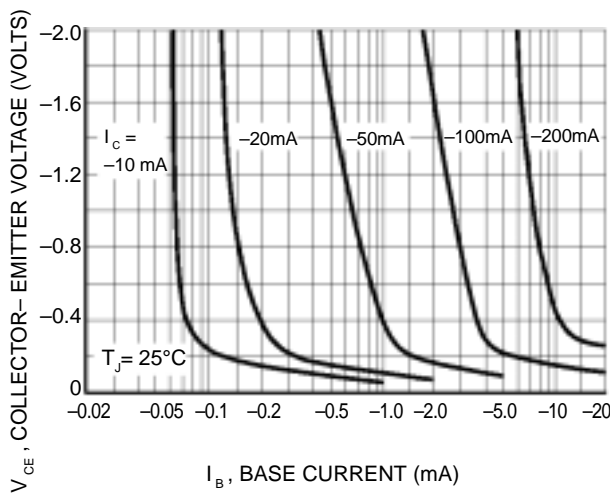

$I_B$ , BASE CURRENT (mA)  
Figure 9. Collector Saturation Region

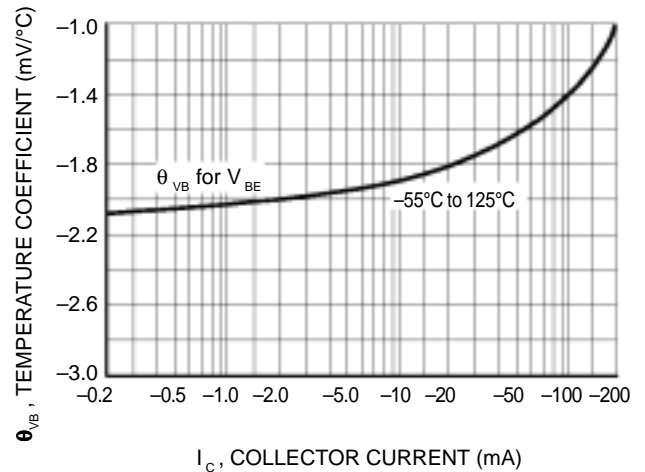

$I_C$ , COLLECTOR CURRENT (mA)  
Figure 10. Base-Emitter Temperature Coefficient

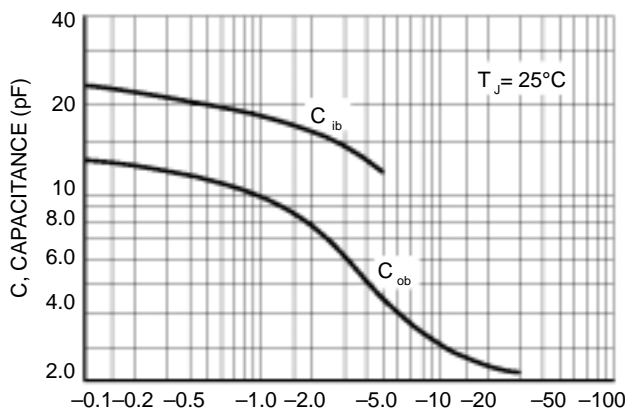

$V_R$ , REVERSE VOLTAGE (VOLTS)  
Figure 11. Capacitance

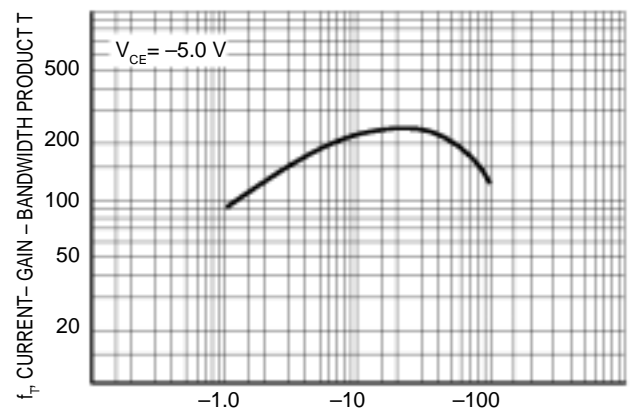

$I_C$ , COLLECTOR CURRENT (mA)  
Figure 12. Current-Gain - Bandwidth Product

### LBC857CLT1G Series , S-LBC857CLT1G Series

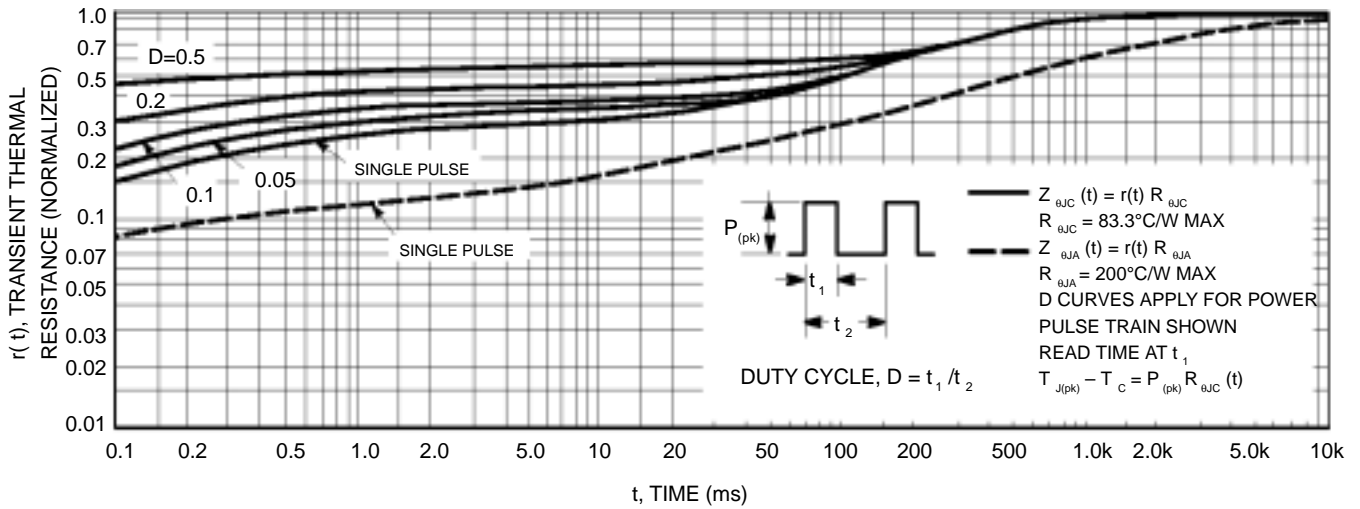

Figure 13. Thermal Response

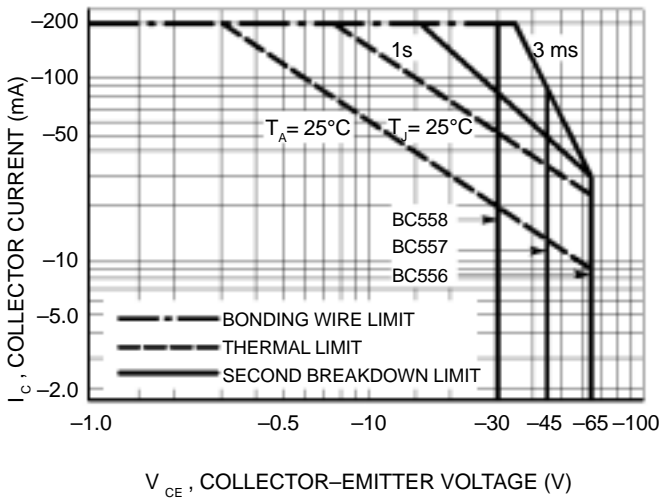

Figure 14. Active Region Safe Operating Area

The safe operating area curves indicate  $I_C - V_{CE}$  limits of the transistor that must be observed for reliable operation. Collector load lines for specific circuits must fall below the limits indicated by the applicable curve.

The data of Figure 14 is based upon  $T_{J(pk)} = 150^\circ\text{C}$ ;  $T_C$  or  $T_A$  is variable depending upon conditions. Pulse curves are valid for duty cycles to 10% provided  $T_{J(pk)} \leq 150^\circ\text{C}$ .  $T_{J(pk)}$  may be calculated from the data in Figure 13. At high case or ambient temperatures, thermal limitations will reduce the power that can be handled to values less than the limitations imposed by the secondary breakdown.

## LBC857CLT1G Series , S-LBC857CLT1G Series

### SOT-23

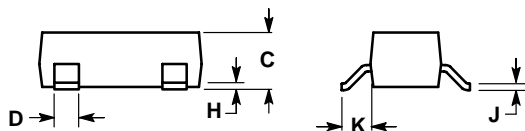
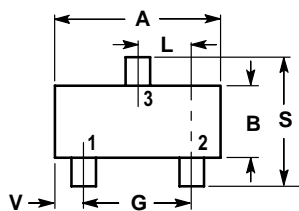

NOTES:

1. DIMENSIONING AND TOLERANCING PER ANSI Y14.5M, 1982.
2. CONTROLLING DIMENSION: INCH.

DIM	INCHES		MILLIMETERS	
	MIN	MAX	MIN	MAX
A	0.1102	0.1197	2.80	3.04
B	0.0472	0.0551	1.20	1.40
C	0.0350	0.0440	0.89	1.11
D	0.0150	0.0200	0.37	0.50
G	0.0701	0.0807	1.78	2.04
H	0.0005	0.0040	0.013	0.100
J	0.0034	0.0070	0.085	0.177
K	0.0140	0.0285	0.35	0.69
L	0.0350	0.0401	0.89	1.02
S	0.0830	0.1039	2.10	2.64
V	0.0177	0.0236	0.45	0.60

