

MITSUBISHI RF POWER TRANSISTOR 2SC3629

NPN EPITAXIAL PLANAR TYPE

DESCRIPTION

2SC3629 is a silicon NPN epitaxial planar type transistor designed for RF power amplifiers in UHF band 7.2 volts operation applications.

FEATURES

- High gain: $G_{pe} \geq 7.7\text{dB}$
@ $V_{CC} = 7.2\text{V}$, $f = 520\text{MHz}$, $P_{in} = 0.2\text{W}$
- Ability of withstanding more than 20:1 load VSWR when operated at $f = 520\text{MHz}$, $V_{CC} = 9\text{V}$, $P_o = 1.2\text{W}$, $T_c = 25^\circ\text{C}$.
- Emitter ballasted construction.
- Flange type ceramic package.

APPLICATION

Output stage of 1W output mobile radio equipment in UHF band

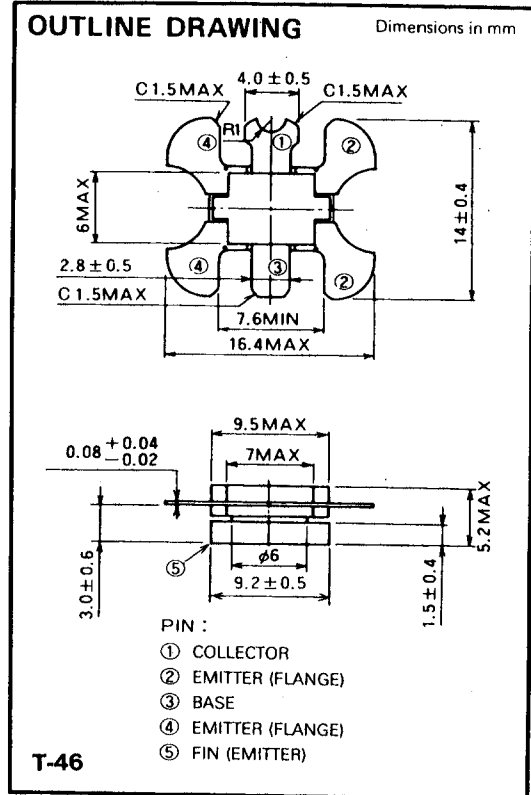

ABSOLUTE MAXIMUM RATINGS ($T_c = 25^\circ\text{C}$ unless otherwise specified)

Symbol	Parameter	Conditions	Ratings	Unit
V_{CBO}	Collector to base voltage		20	V
V_{EBO}	Emitter to base voltage		3.5	V
V_{CEO}	Collector to emitter voltage	$R_{BE} = \infty$	9	V
I_C	Collector current		1	A
P_C	Collector dissipation	$T_c = 25^\circ\text{C}$	5	W
T_j	Junction temperature		175	$^\circ\text{C}$
T_{stg}	Storage temperature		-55 to 175	$^\circ\text{C}$
R_{th-c}	Thermal resistance		30	$^\circ\text{C}/\text{W}$

Note. Above parameters are guaranteed independently.

ELECTRICAL CHARACTERISTICS ($T_c = 25^\circ\text{C}$ unless otherwise specified)

Symbol	Parameter	Test conditions	Limits			Unit
			Min	Typ	Max	
$V_{(BR)EBO}$	Emitter to base breakdown voltage	$I_C = 10\text{mA}$, $I_E = 0$	20			V
$V_{(BR)CBO}$	Collector to base breakdown voltage	$I_E = 1\text{mA}$, $I_C = 0$	3.5			V
$V_{(BR)CEO}$	Collector to emitter breakdown voltage	$I_C = 10\text{mA}$, $R_{BE} = \infty$	9			V
I_{CBO}	Collector cutoff current	$V_{CB} = 10\text{V}$, $I_E = 0$			200	μA
I_{EBO}	Emitter cutoff current	$V_{EB} = 2\text{V}$, $I_C = 0$			200	μA
h_{FE}	DC forward current gain *	$V_{CE} = 5\text{V}$, $I_C = 0.1\text{A}$	20	50	180	—
P_O	Output power	$V_{CC} = 7.2\text{V}$, $f = 520\text{MHz}$, $P_{in} = 0.2\text{W}$	1.2	1.5		W
η_C	Collector efficiency		55	60		%

Note. * Pulse test, $P_W = 150\mu\text{s}$, duty = 5%.

Above parameters, ratings, limits and conditions are subject to change.

TEST CIRCUIT (f=520MHz)

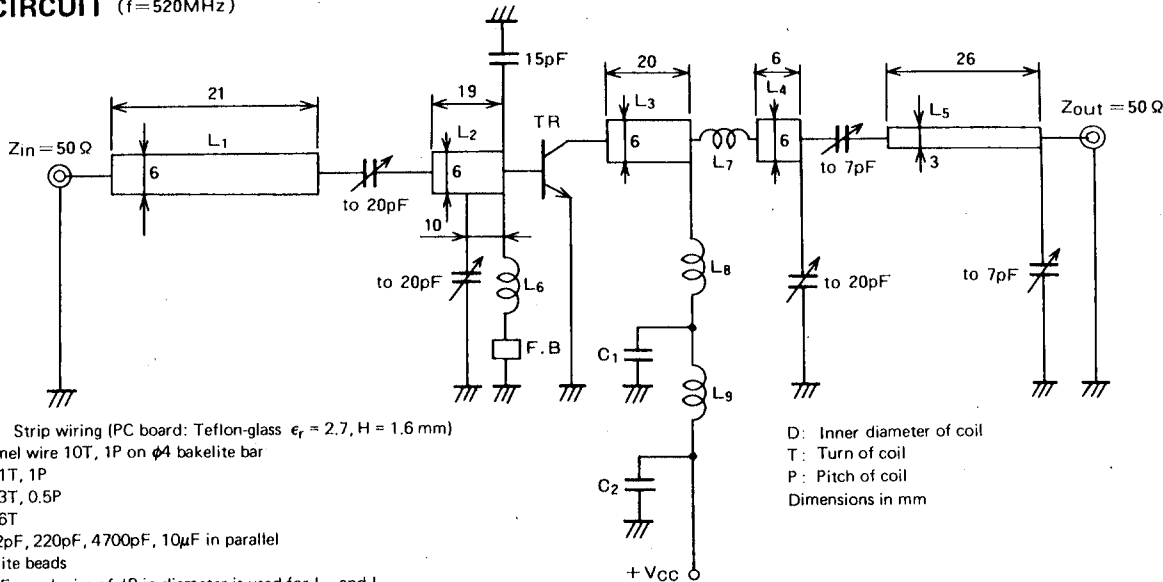

TYPICAL PERFORMANCE DATA

COLLECTOR OUTPUT CAPACITANCE VS. COLLECTOR TO BASE VOLTAGE

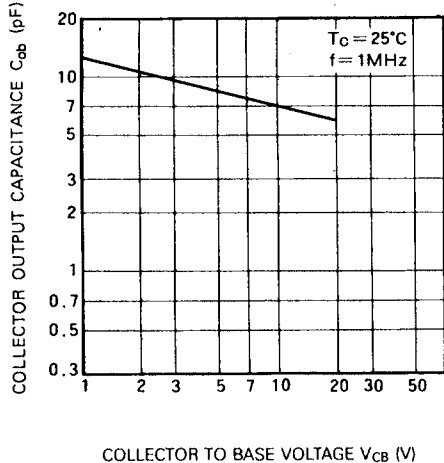

COLLECTOR DISSIPATION VS. CASE TEMPERATURE

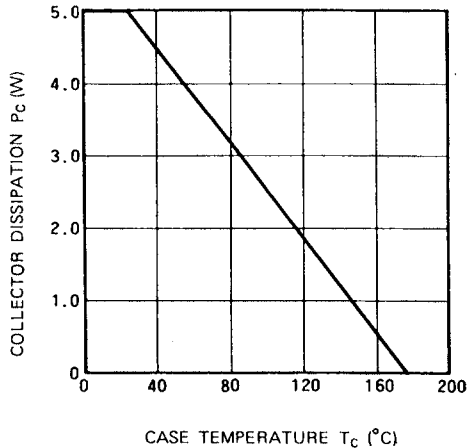

NPN EPITAXIAL PLANAR TYPE

OUTPUT POWER, COLLECTOR EFFICIENCY VS. INPUT POWER

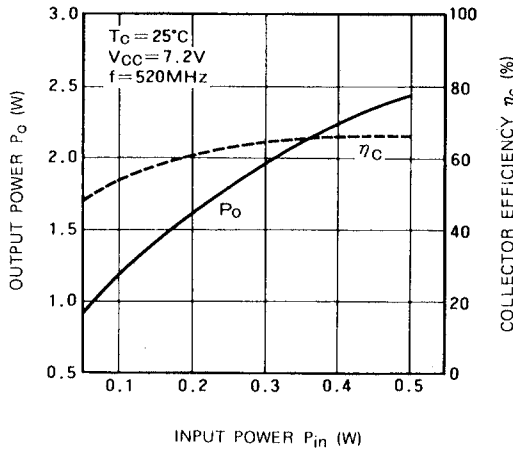

OUTPUT POWER VS. COLLECTOR SUPPLY VOLTAGE VARIATION

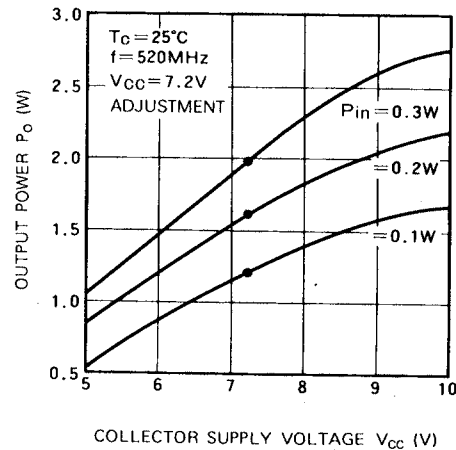

INPUT/OUTPUT IMPEDANCE VS. FREQUENCY

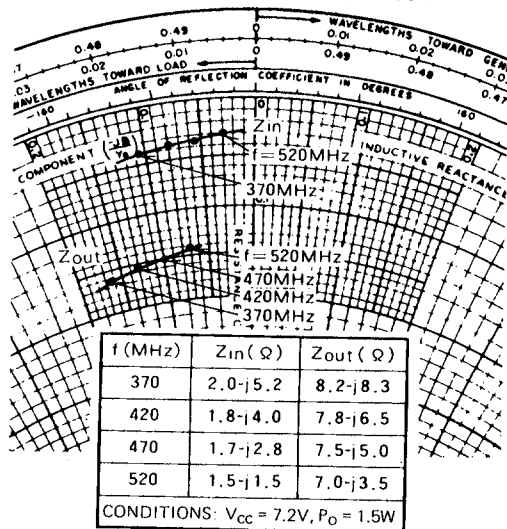

OUTPUT POWER VS. FREQUENCY

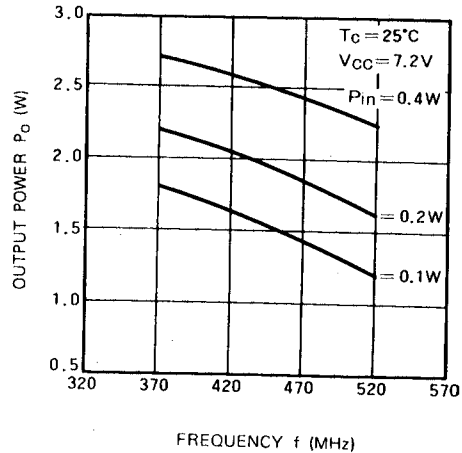

PRECAUTIONS FOR MOUNTING HIGH-FREQUENCY HIGH-OUTPUT TRANSISTOR FOR MOBILE RADIO EQUIPMENT

When mounting high-frequency, high-output transistors for mobile radio equipment (flange screw fastening part cut package), care should be taken to the following points.

1. When mounting the device to the heat sink, silicon compound should be applied to the heat sink and device heat radiating fin and apply the device to the heat sink using a proper fastening tool.
2. If the device is soldered directly to heat sink, excessive thermal stress will result in deteriorating the reliability. Do not use this mounting method.
3. Care should be taken, if the device is applied to the heat sink, the force of soldering the leads to the printed circuit board results in continual mechanical stress, deteriorating the reliability and performance of the system.
4. Refer to Mitsubishi's DATABOOK or manuals for transistors, small-signal diodes and integrated circuit modules for mounting and handling of the device.