

3-644461-2 ✓ ACTIVE



## MTA 156

TE Internal #: 3-644461-2

Standard Rectangular Connectors, Connector Assembly,  
Receptacle, Mating Alignment, Polarization Mating Alignment  
Type, MTA 156

[View on TE.com >](#)

Connectors > Rectangular Connectors > Standard Rectangular Connectors

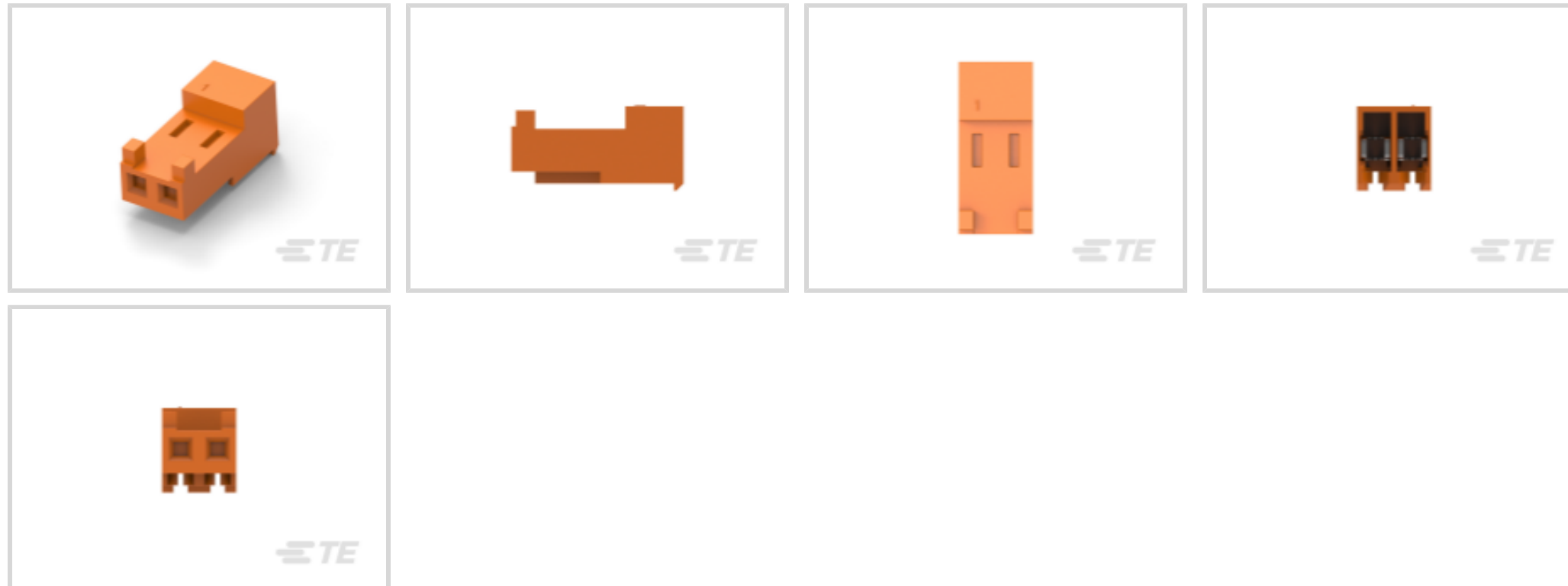

Connector Product Type: **Connector Assembly**

Connector & Housing Type: **Receptacle**

Mating Alignment: **With**

Mating Alignment Type: **Polarization**

Mating Retention: **Without**

### Features

#### Product Type Features

Compatible With Discrete Wire Type	Stranded
Connector Product Type	Connector Assembly
Connector & Housing Type	Receptacle
Connector System	Wire-to-Board
Sealable	No
Connector & Contact Terminates To	Wire & Cable

#### Configuration Features

Number of Cavities	2
Contacts Preloaded	Yes
Number of Positions	2
Number of Rows	1

#### Electrical Characteristics

Operating Voltage	600 VAC
-------------------	---------

#### Contact Features



Contact Type	Receptacle
Wire Contact Termination Area Plating Material	Tin
Contact Underplating Material	Nickel
Contact Mating Area Plating Material	Tin
Contact Retention Within Housing	With
Contact Current Rating (Max)	7 A

### Termination Features

Termination Method to Wire & Cable	Insulation Displacement (IDC)
------------------------------------	-------------------------------

### Mechanical Attachment

Contact Retention Type Within Housing	Locking Lance
Mating Alignment	With
Mating Alignment Type	Polarization
Mating Retention	Without
Connector Mounting Type	Cable Mount (Free-Hanging)

### Housing Features

Housing Material	Nylon
Housing Color	Orange
Centerline (Pitch)	3.96 mm[.156 in]

### Dimensions

Connector Height	18.42 mm[.725 in]
Product Width	9.02 mm[.355 in]
Product Length	7.92 mm[.312 in]
Wire Size	.8 – .9 mm <sup>2</sup>

### Usage Conditions

Operating Temperature Range	-55 – 105 °C[-67 – 221 °F]
-----------------------------	----------------------------

### Operation/Application

Shielded	No
Circuit Application	Power

### Industry Standards

CSA Rating	LR 7189
UL Rating	Recognized
Agency/Standard	CSA, UL



Approved Standards	UL E28476
UL Flammability Rating	UL 94V-2

### Packaging Features

Packaging Quantity	250
Packaging Method	Bag/Box

### Product Compliance

[For compliance documentation, visit the product page on TE.com>](#)

EU RoHS Directive 2011/65/EU	Compliant
EU ELV Directive 2000/53/EC	Compliant
China RoHS 2 Directive MIIT Order No 32, 2016	No Restricted Materials Above Threshold
EU REACH Regulation (EC) No. 1907/2006	Current ECHA Candidate List: JUNE 2023 (235) Candidate List Declared Against: JAN 2023 (233) Does not contain REACH SVHC
Halogen Content	Low Halogen - Br, Cl, F, I < 900 ppm per homogenous material. Also BFR/CFR/PVC Free
Solder Process Capability	Not applicable for solder process capability

#### Product Compliance Disclaimer

This information is provided based on reasonable inquiry of our suppliers and represents our current actual knowledge based on the information they provided. This information is subject to change. The part numbers that TE has identified as EU RoHS compliant have a maximum concentration of 0.1% by weight in homogenous materials for lead, hexavalent chromium, mercury, PBB, PBDE, DBP, BBP, DEHP, DIBP, and 0.01% for cadmium, or qualify for an exemption to these limits as defined in the Annexes of Directive 2011/65/EU (RoHS2). Finished electrical and electronic equipment products will be CE marked as required by Directive 2011/65/EU. Components may not be CE marked. Additionally, the part numbers that TE has identified as EU ELV compliant have a maximum concentration of 0.1% by weight in homogenous materials for lead, hexavalent chromium, and mercury, and 0.01% for cadmium, or qualify for an exemption to these limits as defined in the Annexes of Directive 2000/53/EC (ELV). Regarding the REACH Regulation, the information TE provides on SVHC in articles for this part number is based on the latest European Chemicals Agency (ECHA) 'Guidance on requirements for substances in articles' posted at this URL: <https://echa.europa.eu/guidance-documents/guidance-on-reach>

### Compatible Parts



Also in the Series | **MTA 156**

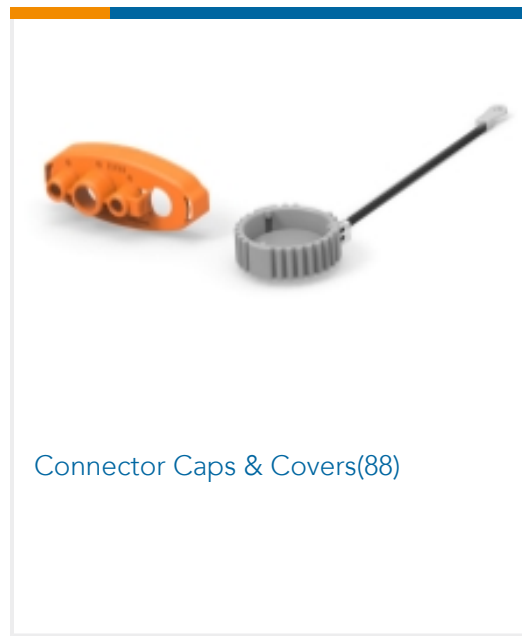

Connector Caps & Covers(88)

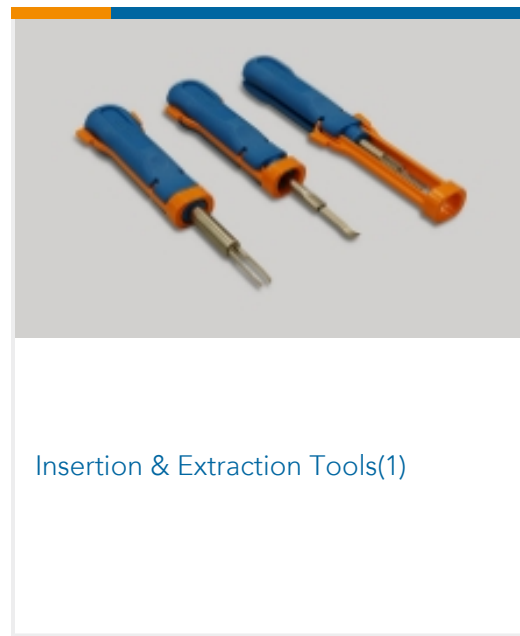

Insertion & Extraction Tools(1)

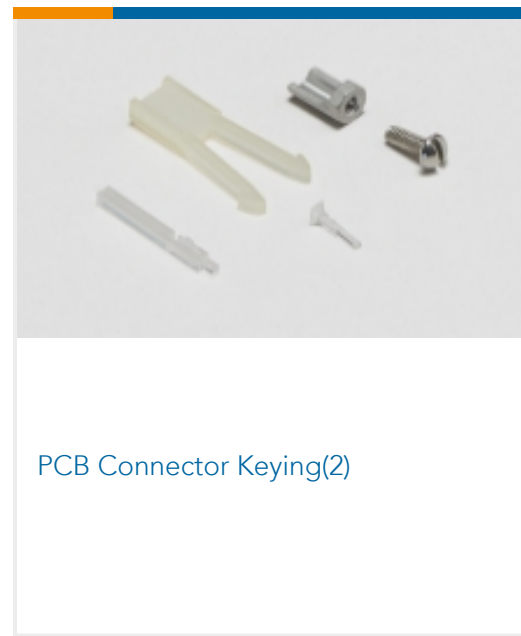

PCB Connector Keying(2)

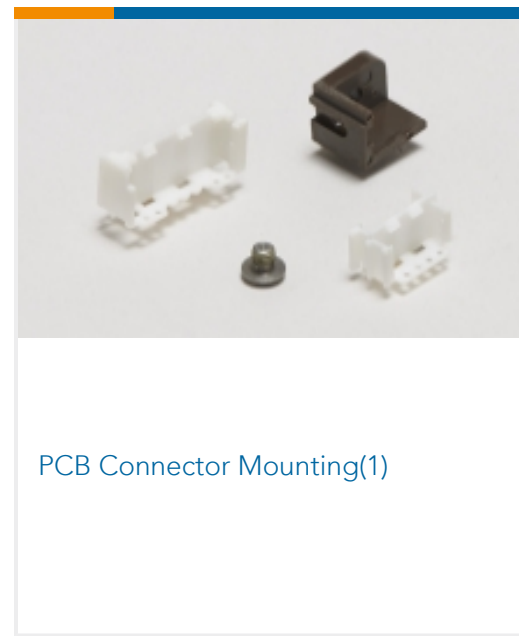

PCB Connector Mounting(1)



PCB Headers & Receptacles(314)

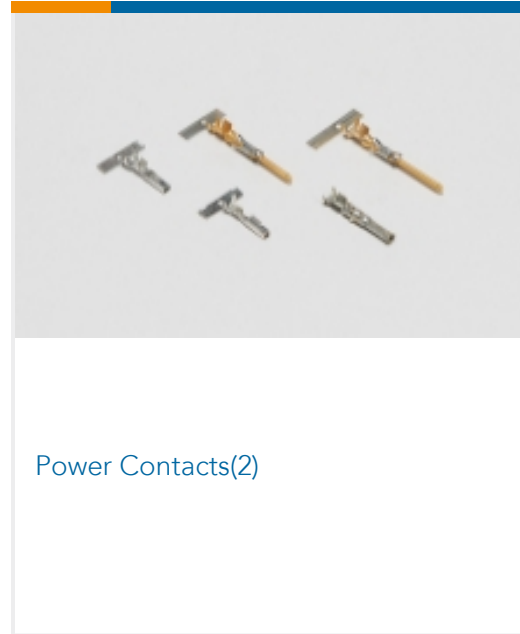

Power Contacts(2)



Rectangular Power Connectors(698)

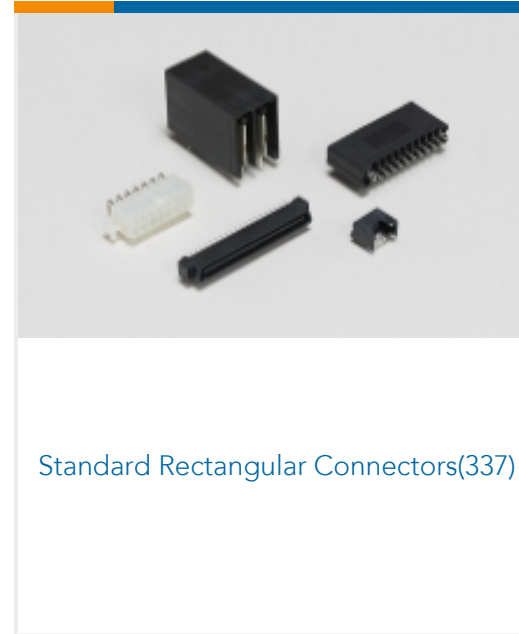

Standard Rectangular Connectors(337)

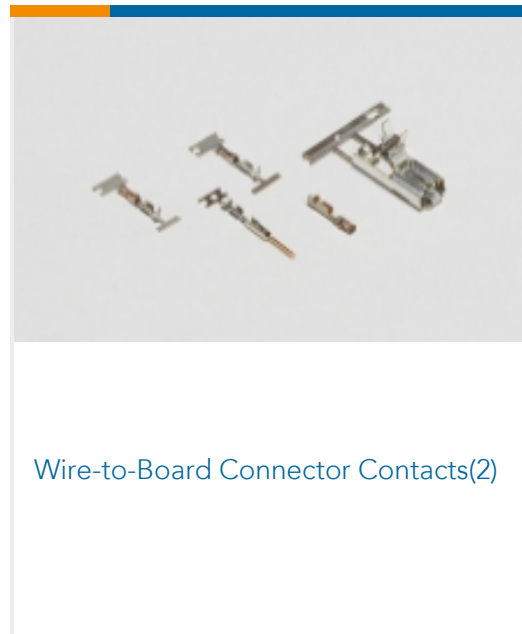

Wire-to-Board Connector Contacts(2)

## Customers Also Bought



TE Part #206070-8  
CABLE CLAMP KIT #17



TE Part #DT04-2P  
REC, 2P, GRY, N



TE Part #DT06-2S  
PLG, 2P, GRY, N



TE Part #W2S  
Wedgelocks: DEUTSCH DT



TE Part #0462-201-16141  
DEUTSCH Solid Contacts



TE Part #282104-1  
AMP SUPERSEAL 1.5MM,  
CONNECTOR HOUSING

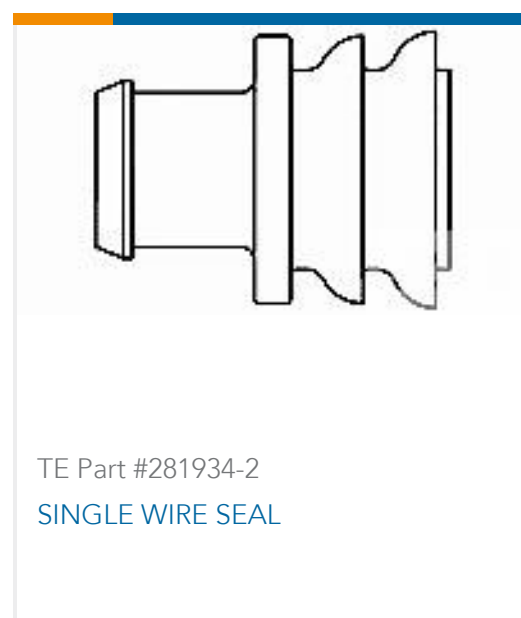

TE Part #281934-2  
SINGLE WIRE SEAL

## Documents





### Product Drawings

#### 02P MTA156 CONN ASSY 18AWG LF

English

---

### CAD Files

#### 3D PDF

3D

#### Customer View Model

[ENG\\_CVM\\_CVM\\_3-644461-2\\_E.2d\\_dxf.zip](#)

English

#### Customer View Model

[ENG\\_CVM\\_CVM\\_3-644461-2\\_E.3d\\_igs.zip](#)

English

#### Customer View Model

[ENG\\_CVM\\_CVM\\_3-644461-2\\_E.3d\\_stp.zip](#)

English

By downloading the CAD file I accept and agree to the [Terms and Conditions](#) of use.

---

### Product Specifications

#### Application Specification

Japanese

#### Application Specification

English

#### MTA 156 Ribbon Cable Connector Assemblies (English And Spanish)

English

#### MTA 156 Ribbon Cable Connector Assemblies (English And Spanish)

Japanese

---

### Agency Approvals

#### Agency Approval Document

English