

Alternistor Triacs

(6 – 40 Amps)

General Description

Teccor offers bidirectional alternistors with current ratings from 6 to 40 amperes and voltages from 200 to 1000 volts as part of Teccor's broad line of thyristors. Teccor's alternistor has been specifically designed for applications that switch highly inductive loads. A special chip offers the same performance as two thyristors (SCRs) wired inverse parallel (back-to-back), providing better turn-off behavior than a standard triac. An alternistor may be triggered from a blocking to conduction state for either polarity of applied AC voltage with operating modes in Quadrants I, II, and III.

This new chip construction provides two electrically separate SCR structures, providing enhanced dv/dt characteristics while retaining the advantages of a single chip device.

All alternistors have glass-passivated junctions to ensure long term reliability and parameter stability. Teccor's glass offers a reliable barrier against junction contamination.

These alternistors are offered in TO-218X, TO-218AC, FastPak, and TO-220AB packages. Teccor's TO-218X package has been designed for heavy, steady power-handling capability. It features large eyelet terminals for ease of soldering heavy gauge hook-up wire. All the isolated packages have a standard isolation voltage rating of $2500V_{RMS}$.

Variations of devices covered in this data sheet are available for custom design applications. Please consult factory for further information.

Features

- High surge current capability
- Glass-passivated junctions
- 2500VAC isolation for "L," "J," "P," and "K"
- High commutating dv/dt
- High static dv/dt

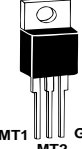
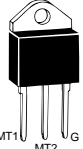
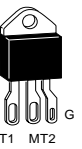
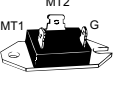
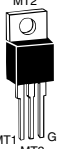
I _{T(RMS)}	Part Number					V _{DRM}	I _{GT}			I _{DRM}			V _{GT}		
	Isolated				Non-Isolated		Repetitive Peak Blocking Voltage (1)	DC Gate Trigger Current in Specific Operating Quadrants V _D =12VDC (3) (7) (15) (17)			Peak Off-State Current Gate Open V _{DRM} =Max Rated Value (1) (18)			DC Gate Trigger Voltage V _D =12VDC (2) (6) (15) (17)	
RMS On-State Current Conduction Angle of 360° (4)(16)						Volts		mAmps			mAmps			Volts	
MAX	See "Package Dimensions" section for variations. (11)					MIN	QI	QII	QIII	T _C = 25°C	T _C = 100°C	T _C = 125°C	T _C = 125°C	T _C = 25°C	MAX
6 Amps	Q2006LH4				Q2006RH4	200	35	35	35	0.01	0.5	2.0	0.2	1.5	
	Q4006LH4				Q4006RH4	400	35	35	35	0.01	0.5	2.0	0.2	1.5	
	Q5006LH4				Q5006RH4	500	35	35	35	0.01	0.5	2.0	0.2	1.5	
	Q6006LH4				Q6006RH4	600	35	35	35	0.01	0.5	2.0	0.2	1.5	
	Q7006LH4				Q7006RH4	700	35	35	35	0.01	0.5	2.0	0.2	1.5	
	**Q8006LH4				**Q8006RH4	800	35	35	35	0.01	0.5	2.0	0.2	1.5	
8 Amps	Q2008LH4				Q2008RH4	200	35	35	35	0.01	0.5	2.0	0.2	1.5	
	Q4008LH4				Q4008RH4	400	35	35	35	0.01	0.5	2.0	0.2	1.5	
	Q5008LH4				Q5008RH4	500	35	35	35	0.01	0.5	2.0	0.2	1.5	
	Q6008LH4				Q6008RH4	600	35	35	35	0.01	0.5	2.0	0.2	1.5	
	Q7008LH4				Q7008RH4	700	35	35	35	0.01	0.5	2.0	0.2	1.5	
	**Q8008LH4				**Q8008RH4	800	35	35	35	0.01	0.5	2.0	0.2	1.5	
10 Amps	Q2010LH5				Q2010RH5	200	50	50	50	0.01	0.5	2.0	0.2	1.5	
	Q4010LH5				Q4010RH5	400	50	50	50	0.01	0.5	2.0	0.2	1.5	
	Q5010LH5				Q5010RH5	500	50	50	50	0.01	0.5	2.0	0.2	1.5	
	Q6010LH5				Q6010RH5	600	50	50	50	0.01	0.5	2.0	0.2	1.5	
	Q7010LH5				Q7010RH5	700	50	50	50	0.01	0.5	2.0	0.2	1.5	
	**Q8010LH5				**Q8010RH5	800	50	50	50	0.01	0.5	2.0	0.2	1.5	
12 Amps	Q2012LH5				Q2012RH5	200	50	50	50	0.01	0.5	2.0	0.2	1.5	
	Q4012LH5				Q4012RH5	400	50	50	50	0.01	0.5	2.0	0.2	1.5	
	Q5012LH5				Q5012RH5	500	50	50	50	0.01	0.5	2.0	0.2	1.5	
	Q6012LH5				Q6012RH5	600	50	50	50	0.01	0.5	2.0	0.2	1.5	
	Q7012LH5				Q7012RH5	700	50	50	50	0.01	0.5	2.0	0.2	1.5	
	**Q8012LH5				**Q8012RH5	800	50	50	50	0.01	0.5	2.0	0.2	1.5	

See General Notes and Electrical Specification Notes on page 6.

** Consult factory for 1000 volt device.

V _{TM}	I _H	I _{GT} M	P _{GM}	P _{G(AV)}	I _{TSM}		dv/dt (c)	dv/dt		tgt	I ² t	di/dt
					Amps			Volts/μSec				
Peak On-State Voltage at Max Rated RMS Current T _C = 25°C (1) (5)	Holding Current (DC) Gate Open (1) (8) (12)	Peak Gate Trigger Current (14)	Peak Gate Power Dissipation (14) I _{GT} ≤ I _{GT} M	Average Gate Power Dissipation	Peak One Cycle Surge (9) (13)		Critical Rate-of-Rise of Commutation Voltage at Rated V _{DRM} and I _{T(RMS)} Commutating di/dt = 0.54 Rated I _{T(RMS)} /ms Gate Unenergized (1) (4) (13)	Critical Rate-of-Rise of Off-State Voltage at Rated V _{DRM} Gate Open (1)		Gate Controlled Turn-On Time I _{GT} = 300mA 0.1μs Rise Time (10)	RMS Surge (Non-Repetitive) On-State Current for period of 8.3 ms for Fusing	Maximum Rate -of-Change of On-State Current (19)
Volts	mAmps	Amps	Watts	Watts	60Hz	50Hz		T _C = 100°C	T _C = 125°C			
MAX	MAX						MIN	MIN		TYP		
1.6	35	1.6	18	0.5	80	65	20	750	600	4	26.5	70
1.6	35	1.6	18	0.5	80	65	20	575	450	4	26.5	70
1.6	35	1.6	18	0.5	80	65	20	500	400	4	26.5	70
1.6	35	1.6	18	0.5	80	65	20	425	350	4	26.5	70
1.6	35	1.6	18	0.5	80	65	20	375	300	4	26.5	70
1.6	35	1.6	18	0.5	80	65	20	300	250	4	26.5	70
1.6	35	2.0	20	0.5	100	83	25	750	600	4	41	70
1.6	35	2.0	20	0.5	100	83	25	575	450	4	41	70
1.6	35	2.0	20	0.5	100	83	25	500	400	4	41	70
1.6	35	2.0	20	0.5	100	83	25	425	350	4	41	70
1.6	35	2.0	20	0.5	100	83	25	375	300	4	41	70
1.6	35	2.0	20	0.5	100	83	25	300	250	4	41	70
1.6	50	2.0	20	0.5	120	110	30	1150	1000	4	60	70
1.6	50	2.0	20	0.5	120	110	30	1000	750	4	60	70
1.6	50	2.0	20	0.5	120	110	30	925	700	4	60	70
1.6	50	2.0	20	0.5	120	110	30	850	650	4	60	70
1.6	50	2.0	20	0.5	120	110	30	775	600	4	60	70
1.6	50	2.0	20	0.5	120	110	30	650	500	4	60	70
1.6	50	2.0	20	0.5	120	110	30	1150	1000	4	60	70
1.6	50	2.0	20	0.5	120	110	30	1000	750	4	60	70
1.6	50	2.0	20	0.5	120	110	30	925	700	4	60	70
1.6	50	2.0	20	0.5	120	110	30	850	650	4	60	70
1.6	50	2.0	20	0.5	120	110	30	775	600	4	60	70
1.6	50	2.0	20	0.5	120	110	30	650	500	4	60	70

See General Notes and Electrical Specification Notes on page 6.

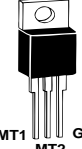
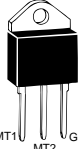
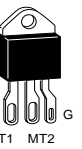
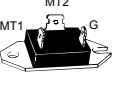
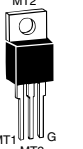
I _{T(RMS)}	Part Number					V _{DRM}	I _{GT}			I _{DRM}			V _{GT}		
	Isolated				Non-Isolated		Repetitive Peak Blocking Voltage (1)	DC Gate Trigger Current in Specific Operating Quadrants V _D =12VDC (3) (7) (15) (17)			Peak Off-State Current Gate Open V _{DRM} =Max Rated Value (1) (18)			DC Gate Trigger Voltage V _D =12VDC (2) (6) (15) (17)	
RMS On-State Current Conduction Angle of 360° (4)(16)						Volts		mAmps			mAmps			Volts	
MAX	See "Package Dimensions" section for variations. (11)					MIN	QI	QII	QIII	T _C = 25°C	T _C = 100°C	T _C = 125°C	T _C = 125°C	T _C = 25°C	MAX
16 Amps	Q2016LH3				Q2016RH3	200	20	20	20	.05	0.5	2.0	0.2	1.5	
	Q4016LH3				Q4016RH3	400	20	20	20	.05	0.5	2.0	0.2	1.5	
	Q5016LH3				Q5016RH3	500	20	20	20	.05	0.5	2.0	0.2	1.5	
	Q6016LH3				Q6016RH3	600	20	20	20	.05	0.5	2.0	0.2	1.5	
	Q7016LH3				Q7016RH3	700	20	20	20	0.1	1.0	3.0	0.2	1.5	
	**Q8016LH3				**Q8016RH3	800	20	20	20	0.1	1.0	3.0	0.2	1.5	
	Q2016LH4				Q2016RH4	200	35	35	35	.05	0.5	2.0	0.2	2.0	
	Q4016LH4				Q4016RH4	400	35	35	35	.05	0.5	2.0	0.2	2.0	
	Q5016LH4				Q5016RH4	500	35	35	35	.05	0.5	2.0	0.2	2.0	
	Q6016LH4				Q6016RH4	600	35	35	35	.05	0.5	2.0	0.2	2.0	
	Q7016LH4				Q7016RH4	700	35	35	35	0.1	1.0	3.0	0.2	2.0	
	**Q8016LH4				**Q8016RH4	800	35	35	35	0.1	1.0	3.0	0.2	2.0	
	Q2016LH6				Q2016RH6	200	80	80	80	.05	0.5	2.0	0.2	2.5	
	Q4016LH6				Q4016RH6	400	80	80	80	.05	0.5	2.0	0.2	2.5	
Q5016LH6				Q5016RH6	500	80	80	80	.05	0.5	2.0	0.2	2.5		
Q6016LH6				Q6016RH6	600	80	80	80	.05	0.5	2.0	0.2	2.5		
Q7016LH6				Q7016RH6	700	80	80	80	0.1	1.0	3.0	0.2	2.5		
**Q8016LH6				**Q8016RH6	800	80	80	80	0.1	1.0	3.0	0.2	2.5		
25 Amps	Q2025L6	Q2025K6	Q2025J6	Q2025P	Q2025R6	200	80	80	80	.05	0.5	2.0	0.2	2.5	
	Q4025L6	Q4025K6	Q4025J6	Q4025P	Q4025R6	400	80	80	80	.05	0.5	2.0	0.2	2.5	
	Q5025L6	Q5025K6	Q5025J6	Q5025P	Q5025R6	500	80	80	80	.05	0.5	2.0	0.2	2.5	
	Q6025L6	Q6025K6	Q6025J6	Q6025P	Q6025R6	600	80	80	80	.05	0.5	2.0	0.2	2.5	
	Q7025L6	Q7025K6	Q7025J6	Q7025P	Q7025R6	700	80	80	80	0.1	1.0	3.0	0.2	2.5	
	**Q8025L6	**Q8025K6	Q8025J6	Q8025P	**Q8025R6	800	80	80	80	0.1	1.0	3.0	0.2	2.5	
40 Amps		Q2040K7	Q2040J7	Q2040P		200	100	100	100	0.2	2.0	5.0	0.2	2.5	
		Q4040K7	Q4040J7	Q4040P		400	100	100	100	0.2	2.0	5.0	0.2	2.5	
		Q5040K7	Q5040J7	Q5040P		500	100	100	100	0.2	2.0	5.0	0.2	2.5	
		Q6040K7	Q6040J7	Q6040P		600	100	100	100	0.2	2.0	5.0	0.2	2.5	
		Q7040K7	Q7040J7	Q7040P		700	100	100	100	0.2	2.0	5.0	0.2	2.5	
		**Q8040K7	Q8040J7	Q8040P		800	100	100	100	0.2	2.0	5.0	0.2	2.5	

See General Notes and Electrical Specification Notes on page 6.

** Consult factory for 1000 volt device

V _{TM}	I _H	I _{GT} M	P _{GM}	P _{G(AV)}	I _{TSM}		dv/dt (c)	dv/dt		tgt	I ² t	di/dt
					Amps			Volts/μSec				
Peak On-State Voltage at Max Rated RMS Current T _C = 25°C (1) (5)	Holding Current (DC) Gate Open (1) (8) (12)	Peak Gate Trigger Current (14)	Peak Gate Power Dissipation (14) I _{GT} ≤ I _{GT} M	Average Gate Power Dissipation	Peak One Cycle Surge (9) (13)		Critical Rate-of-Rise of Commutation Voltage at Rated V _{DRM} and I _{T(RMS)} Commutating di/dt = 0.54 Rated I _{T(RMS)} /ms Gate Unenergized (1) (4) (13)	Critical Rate-of-Rise of Off-State Voltage at Rated V _{DRM} Gate Open (1)		Gate Controlled Turn-On Time I _{GT} = 300mA 0.1μs Rise Time (10)	RMS Surge (Non-Repetitive) On-State Current for period of 8.3 ms for Fusing	Maximum Rate -of-Change of On-State Current (19)
Volts	mAmps	Amps	Watts	Watts	60Hz	50Hz		T _C = 100°C	T _C = 125°C			
MAX	MAX						MIN	MIN		TYP		
1.6	35	2.0	20	0.5	200	167	20	500	400	3	166	100
1.6	35	2.0	20	0.5	200	167	20	400	350	3	166	100
1.6	35	2.0	20	0.5	200	167	20	300	250	3	166	100
1.6	35	2.0	20	0.5	200	167	20	300	250	3	166	100
1.6	35	2.0	20	0.5	200	167	20	275	200	3	166	100
1.6	35	2.0	20	0.5	200	167	20	275	200	3	166	100
1.6	50	2.0	20	0.5	200	167	25	650	500	3	166	100
1.6	50	2.0	20	0.5	200	167	25	600	475	3	166	100
1.6	50	2.0	20	0.5	200	167	25	550	425	3	166	100
1.6	50	2.0	20	0.5	200	167	25	500	400	3	166	100
1.6	50	2.0	20	0.5	200	167	25	425	350	3	166	100
1.6	50	2.0	20	0.5	200	167	25	425	350	3	166	100
1.6	70	2.0	20	0.5	200	167	30	875	600	5	166	100
1.6	70	2.0	20	0.5	200	167	30	875	600	5	166	100
1.6	70	2.0	20	0.5	200	167	30	800	520	5	166	100
1.6	70	2.0	20	0.5	200	167	30	800	520	5	166	100
1.6	70	2.0	20	0.5	200	167	30	700	475	5	166	100
1.6	70	2.0	20	0.5	200	167	30	700	475	5	166	100
1.8	100	2.0	20	0.5	250	208	30	875	600	5	259	100
1.8	100	2.0	20	0.5	250	208	30	875	600	5	259	100
1.8	100	2.0	20	0.5	250	208	30	800	520	5	259	100
1.8	100	2.0	20	0.5	250	208	30	800	520	5	259	100
1.8	100	2.0	20	0.5	250	208	30	700	475	5	259	100
1.8	100	2.0	20	0.5	250	208	30	700	475	5	259	100
1.8	120	4.0	40	0.8	400	335	50	1100	700	5	664	150
1.8	120	4.0	40	0.8	400	335	50	1100	700	5	664	150
1.8	120	4.0	40	0.8	400	335	50	1000	625	5	664	150
1.8	120	4.0	40	0.8	400	335	50	1000	625	5	664	150
1.8	120	4.0	40	0.8	400	335	50	900	575	5	664	150
1.8	120	4.0	40	0.8	400	335	50	900	575	5	664	150

See General Notes and Electrical Specification Notes on page 6.

General Notes

- All measurements are made at 60Hz with a resistive load at an ambient temperature of +25°C unless specified otherwise.
- Operating temperature range (T_J) is -40°C to +125°C except 0°C to +125°C for FastPaks.
- Storage temperature range (T_S) is -40°C to +125°C except -20°C to +125°C for FastPaks.
- Lead solder temperature is a maximum of 230°C for 10 seconds maximum $\geq 1/16"$ (1.59mm) from case.
- The case temperature (T_C) is measured as shown on the dimensional outline drawings. See "Package Dimensions" section of this catalog.

Electrical Specification Notes

- (1) For either polarity of MT2 with reference to MT1 terminal.
- (2) For either polarity of gate voltage (V_{GT}) with reference to MT1 terminal.
- (3) See Definition of Quadrants.
- (4) See Figures 4.1 through 4.4 for current rating at specific operating temperature and Figure 4.16 for free air rating (no heat sink).
- (5) See Figures 4.5 and 4.6 for i_T and v_T .
- (6) See Figure 4.7 for V_{GT} vs T_C .
- (7) See Figure 4.8 for I_{GT} vs T_C .
- (8) See Figure 4.9 for I_H vs T_C .
- (9) See Figures 4.10 and 4.11 for surge rating with specific durations.
- (10) See Figure 4.12 for t_{gt} vs I_{GT} .
- (11) See package outlines for lead form configurations. When ordering special lead forming, add type number as suffix to part number.
- (12) Initial on-state current = 400 mA(DC) for 16-40A devices and 100mA for 6-12 Amp devices.
- (13) See Figures 4.1 through 4.4 for maximum allowable case temperature at maximum rated current.
- (14) Pulse width $\leq 10\mu s$.
- (15) For 6-12 Amp devices, $R_L = 60\Omega$; 16 Amp and above, $R_L = 30\Omega$
- (16) 40 Amp pin terminal leads on K package can run 100°C to 125°C.
- (17) Alternistor does not turn on in Quadrant IV.
- (18) $T_C = T_J$ for test conditions in off-state
- (19) $I_{GT} = 200$ mA for 6-12 Amp devices and 500 mA for 16-40 Amp devices with gate pulse having rise time of ≤ 0.1 microsecond.

Gate Characteristics

Teccor triacs may be turned on in the following ways:

- With in-phase signals (using standard AC line) Quadrants I and III are used.
- By applying unipolar pulses (gate always negative)—with negative gate pulses Quadrants II and III are used.

In all cases, if maximum surge capability is required, gate pulses should be a minimum of one magnitude above minimum I_{GT} rating with a steep rising waveform ($\leq 1\mu s$ rise time).

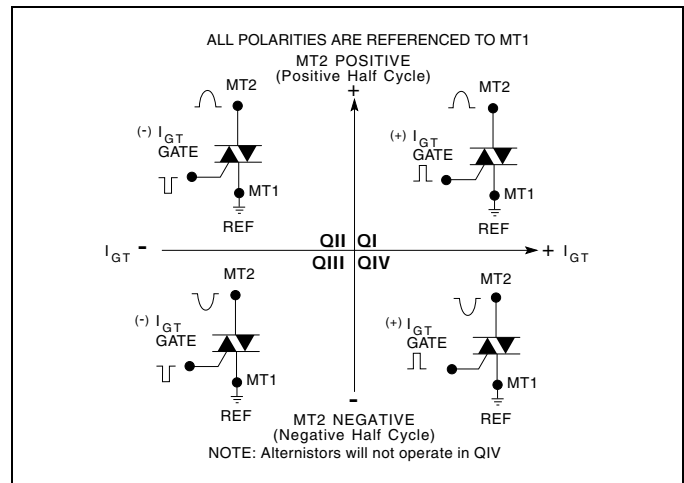

Definition of Quadrants



Electrical Isolation

Teccor's isolated Alternistor packages will withstand a minimum high potential test of 2500 VAC (RMS) from leads to mounting tab, over the operating temperature range of the device. See isolation table below for standard and optional isolation ratings.

ELECTRICAL ISOLATION FROM LEADS TO MOUNTING TAB **				
VAC (RMS)	Isolated TO-218AC	Isolated FASTPAK	Isolated TO-220AB	Isolated TO-218X
2500	Standard	Standard	Standard	Standard
4000	N/A	N/A	Optional *	N/A

* For 4000V isolation, use V suffix in part number.

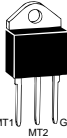
** UL Recognized File E71639

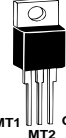
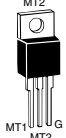
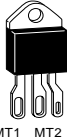
THERMAL RESISTANCE (Steady State)					
$R_{\theta JC} [R_{\theta JA}]$ (TYP.) °C/W					
Type					
6 amps			3.3 [50]	2.1 [45]	
8 amps			2.8	1.8	
10 amps			2.6	1.5	
12 amps			2.3	1.4	
16 amps			2.1	1.3	
25 amps	1.35	1.3	2.0	1.1	1.32
40 amps	0.97	0.9			0.95

** UL Recognized Product per UL File E71639.

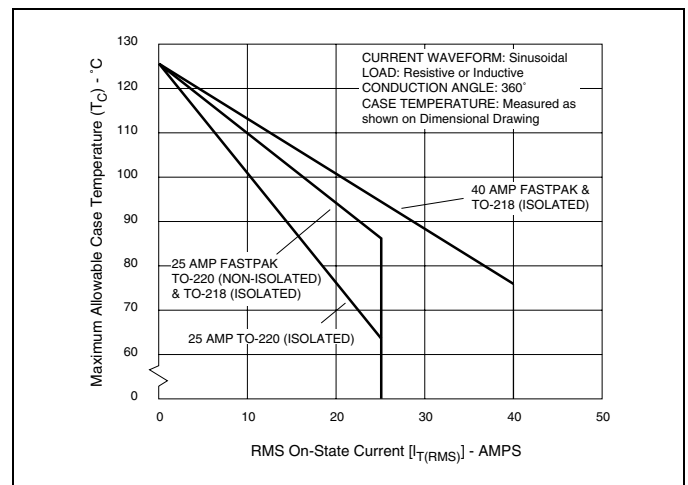
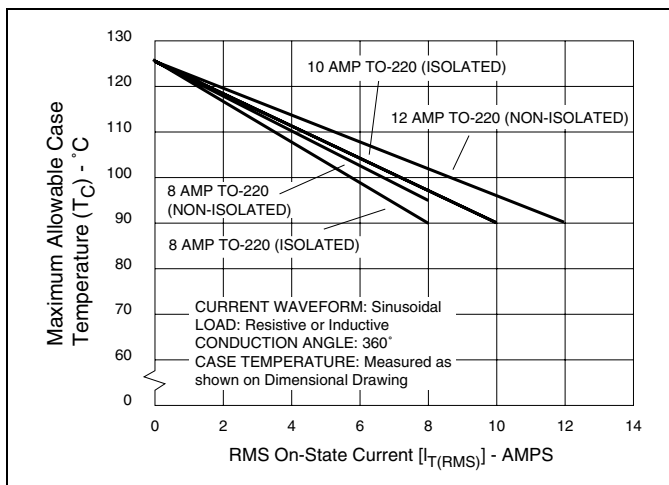
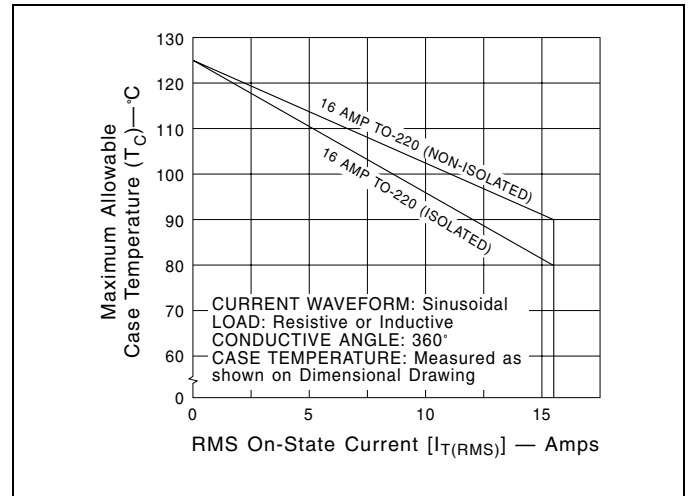
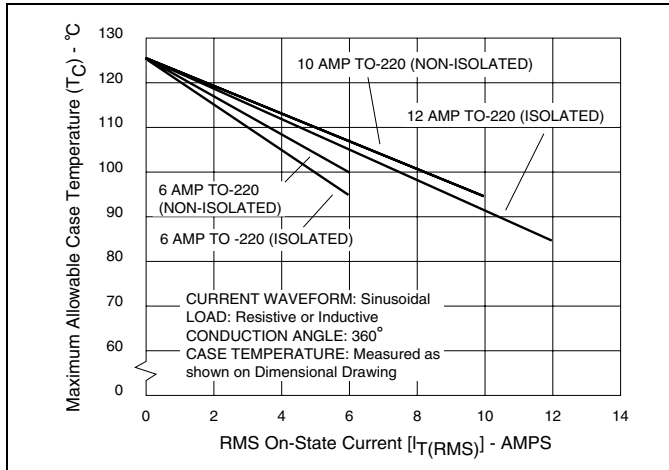

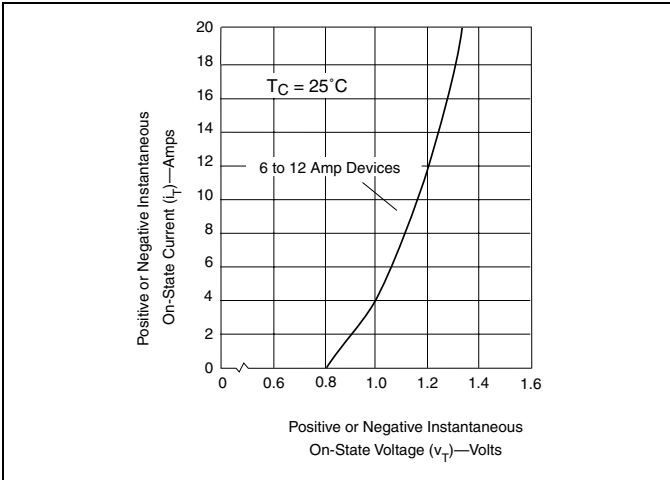

Figure 4.5 On-State Current vs On-State Voltage (Typical) (6-12 Amp Devices)

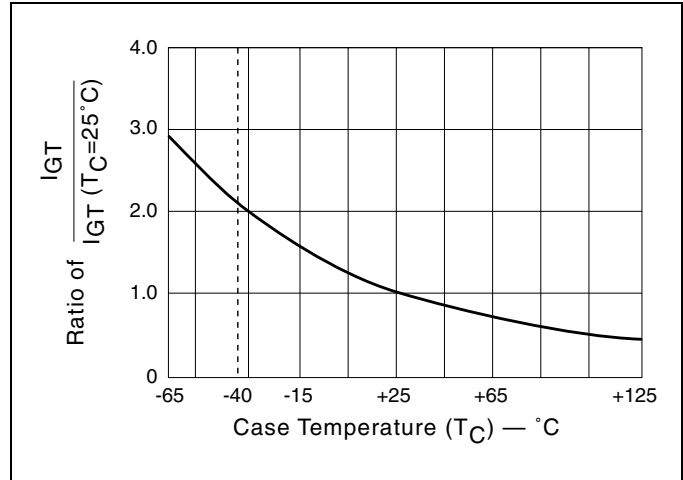

Figure 4.8 Normalized DC Gate Trigger Current for all Quadrants vs Case Temperature

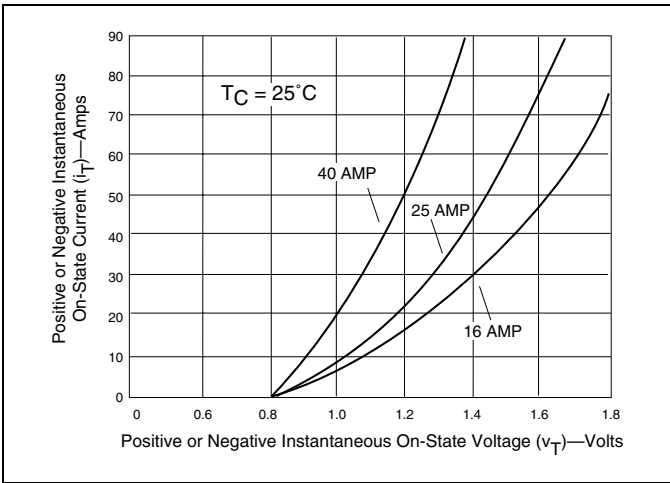

Figure 4.6 On-State Current vs On-State Voltage (Typical) (16-40 Amp Devices)

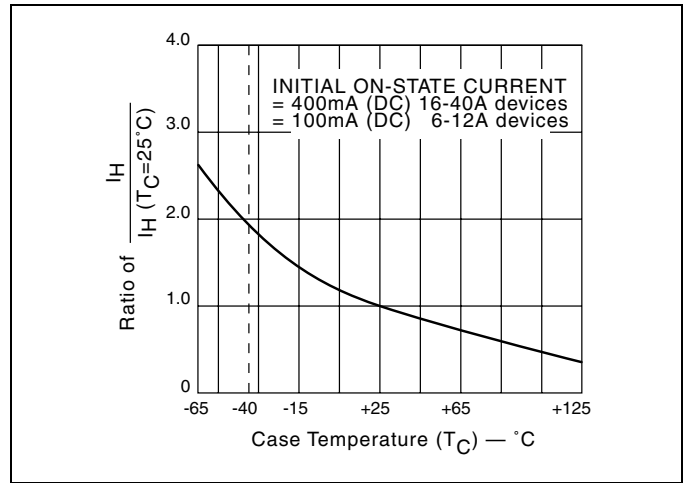

Figure 4.9 Normalized DC Holding Current vs Case Temperature

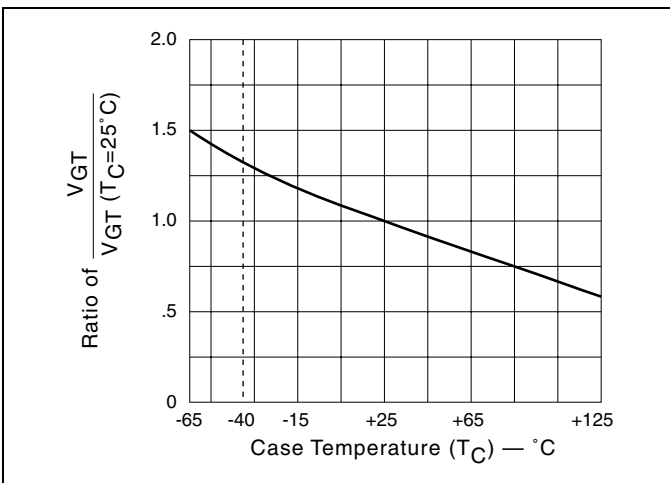

Figure 4.7 Normalized DC Gate Trigger Voltage for all Quadrants vs Case Temperature

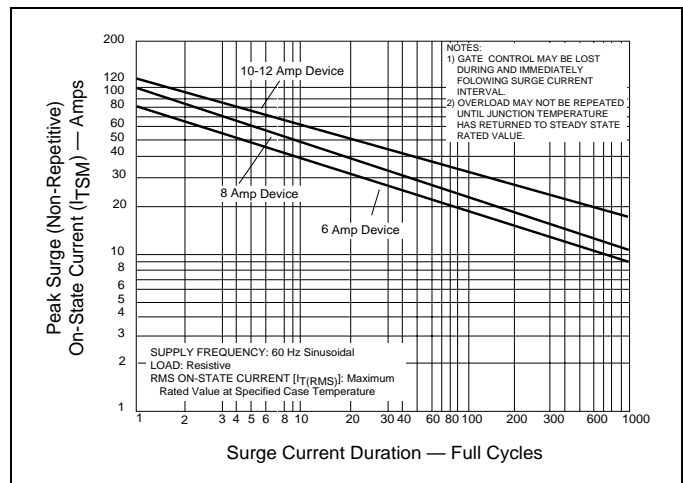

Figure 4.10 Peak Surge Current vs Surge Current Duration (6-12 Amp Devices)

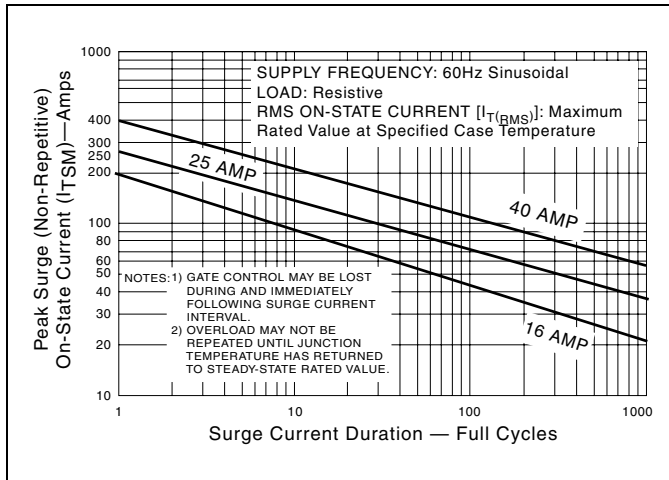

Figure 4.11 Peak Surge Current vs Surge Current Duration (16-40 Amp Devices)

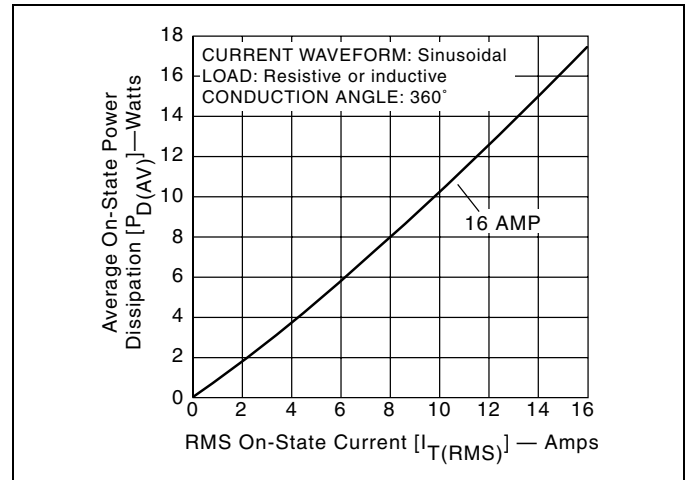

Figure 4.14 Power Dissipation (Typical) vs On-State Current (16 Amp Devices)

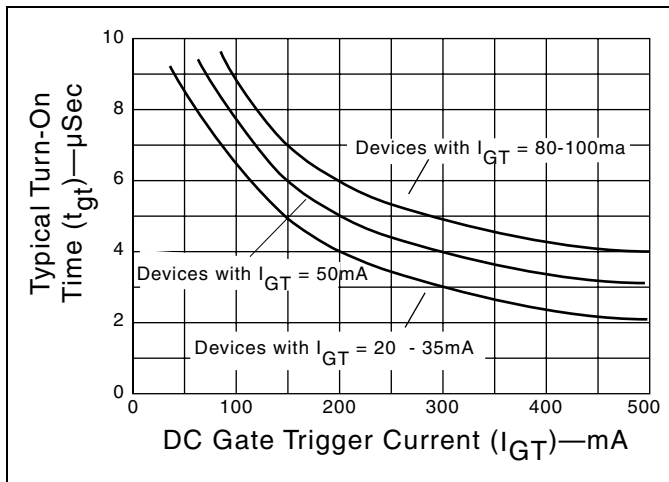

Figure 4.12 Turn-On Time vs Gate Trigger Current (Typical)

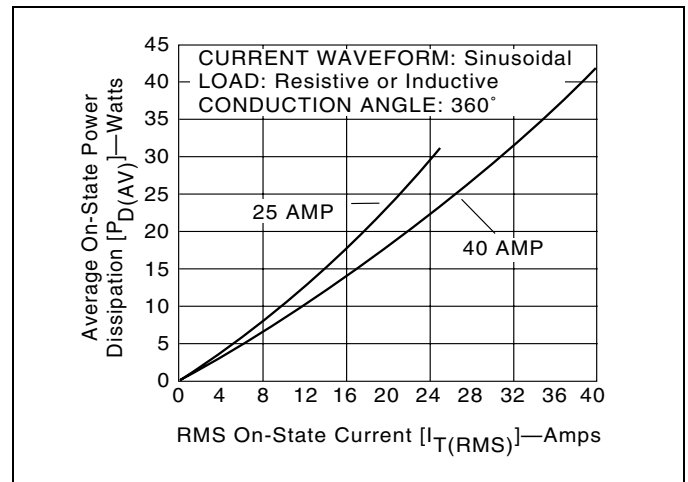

Figure 4.15 Power Dissipation (Typical) vs On-State Current (25 and 40 Amp Devices)

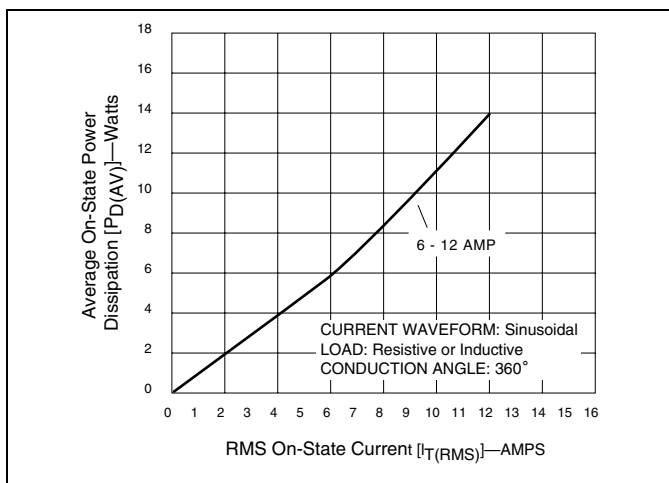

Figure 4.13 Power Dissipation (Typical) vs On-State Current (6-12 Amp Devices)

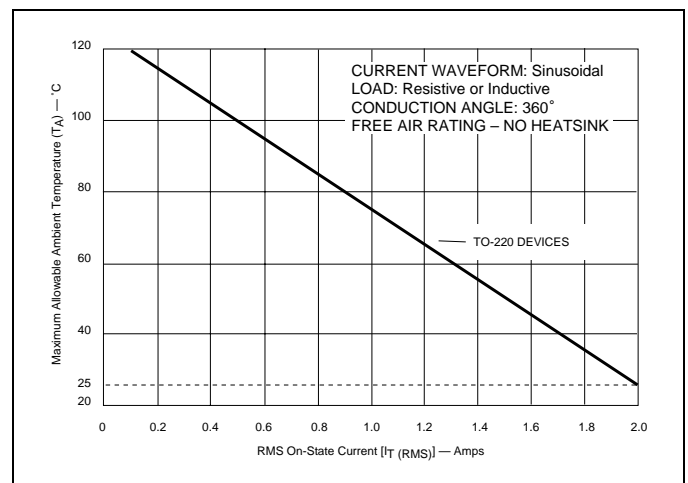

Figure 4.16 Maximum Allowable Ambient Temperature vs On-State Current

