



# UPS1040CTe3

## 10 A Dual Schottky Barrier Rectifiers

### DESCRIPTION

This UPS1040CTe3 in the Powermite3<sup>®</sup> package is a high efficiency center-tap dual Schottky rectifier that is also RoHS compliant offering high current/power capabilities previously found only in much larger packages. They are ideal for SMD applications that operate at high frequencies. In addition to its size advantages, the Powermite3<sup>®</sup> package includes a full metallic bottom that eliminates the possibility of solder flux entrapment during assembly and a unique locking tab act as an efficient heat path to the heat-sink mounting. Its innovative design makes this device ideal for use with automatic insertion equipment.

**IMPORTANT:** For the most current data, consult MICROSEMI's website: <http://www.microsemi.com>

### ABSOLUTE MAXIMUM RATINGS AT 25° C (UNLESS OTHERWISE SPECIFIED)

Rating	Symbol	Value	Unit
Peak Repetitive Reverse Voltage Working Peak Reverse Voltage DC Blocking Voltage	$V_{RRM}$ $V_{RWM}$ $V_R$	40	V
RMS Reverse Voltage	$V_{R(RMS)}$	28	V
Average Rectified Output Current	$I_o$	10	A
Non-Repetitive Peak Forward Surge Current 8.3ms Single half sine wave Superimposed on Rated Load@ $T_c = 90^\circ C$	$I_{FSM}$	150	A
Storage Temperature	$T_{STG}$	-55 to +150	°C
Junction Temperature	$T_J$	-55 to +125	°C


### THERMAL CHARACTERISTICS (UNLESS OTHERWISE SPECIFIED)

Thermal Resistance (dual device)			
Junctions-to Bottom (Case)	$R_{\theta JC}$	2.5	°C/Watt

### KEY FEATURES

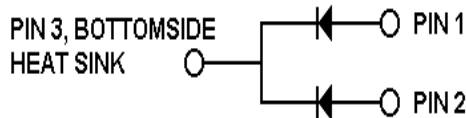
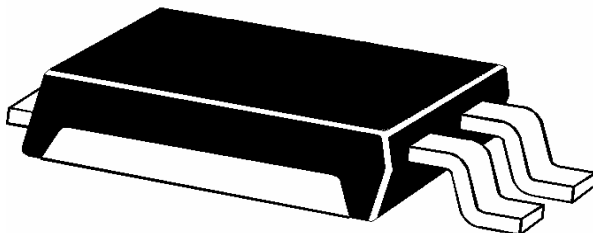
- Very low thermal resistance package
- Dual center-tap Schottky configuration with common cathode
- RoHS Compliant with e3 suffix part number
- Guard-ring-die construction for transient protection
- Efficient heat path with Integral locking bottom metal tab
- Low forward voltage
- Full metallic bottom eliminates flux entrapment
- Compatible with automatic insertion
- Low profile-maximum height of 1mm
- Options for screening in accordance with MIL-PRF-19500 for JAN, JANTX, and JANTXV are available by adding MQ, MX, or MV prefixes respectively to part numbers. For example, designate MXUPS1040CTe3 for a JANTX (consult factory for Tin-Lead plating).
- Optional 100% avionics screening available by adding MA prefix for 100% temperature cycle, thermal impedance and 24 hours HTRB (consult factory for Tin-Lead plating)

### APPLICATIONS/BENEFITS

- Switching and Regulating Power supplies.
- Silicon Schottky (hot carrier) rectifier for minimal reverse voltage recovery
- Elimination of reverse-recovery oscillations to reduce need for EMI filtering
- Charge Pump Circuits
- Reduces reverse recovery loss with low  $I_{RM}$
- Small foot print  = 190 X 270 mils (1:1 Actual size)  
See mounting pad details on pg 5

### MECHANICAL & PACKAGING

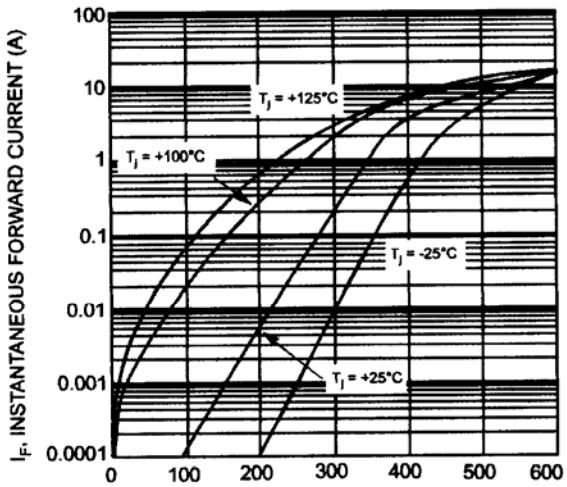
- CASE: Void-free transfer molded thermosetting epoxy compound meeting UL94V-0
- FINISH: Annealed matte-Tin plating over copper and readily solderable per MIL-STD-750 method 2026 (consult factory for Tin-Lead plating)
- POLARITY: See figure (left)
- MARKING: S1040CT•
- WEIGHT: 0.072 gram (approx.)
- Package dimension on last page
- Tape & Reel option: 16 mm tape per Standard EIA-481-B, 5000 on 13" reel



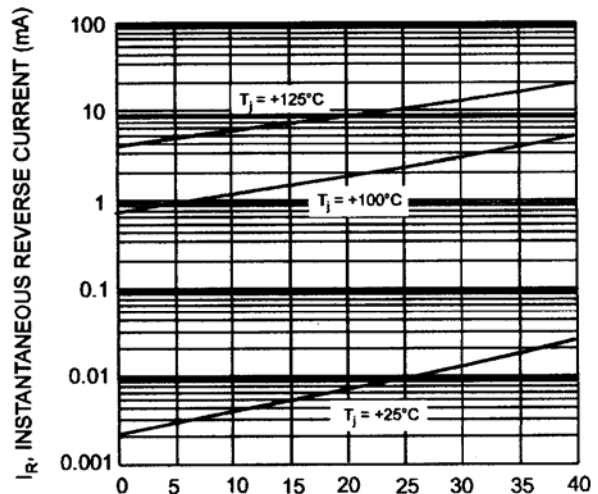
**ELECTRICAL PARAMETERS @ 25°C (unless otherwise specified)**

Parameter	Symbol	Conditions	Min	Typ.	Max	Units
Forward Voltage (Note 1) Per Element	$V_F$	$I_F = 5\text{ A}, T_J = 25\text{ °C}$		0.44	0.48	V
		$I_F = 5\text{ A}, T_J = 100\text{ °C}$		0.39	0.42	
		$I_F = 10\text{ A}, T_J = 25\text{ °C}$		0.51	0.57	
		$I_F = 10\text{ A}, T_J = 100\text{ °C}$		0.50	0.55	
Reverse Breakdown Voltage (Note 1)	$V_{BR}$	$I_R = 500\text{ }\mu\text{A}$	40			V
Reverse Current (Note1) Per Element	$I_R$	$V_R = 35\text{V}, T_J = 25\text{ °C}$		35	150	$\mu\text{A}$
		$V_R = 35\text{V}, T_J = 100\text{ °C}$		4	10	mA
		$V_R = 17.5\text{V}, T_J = 25\text{ °C}$		15	80	$\mu\text{A}$
		$V_R = 17.5\text{V}, T_J = 100\text{ °C}$		2	5	mA
Capacitance Per Element	$C_T$	$V_R = 4\text{ V}; f = 1\text{ MHz}$		375		pF

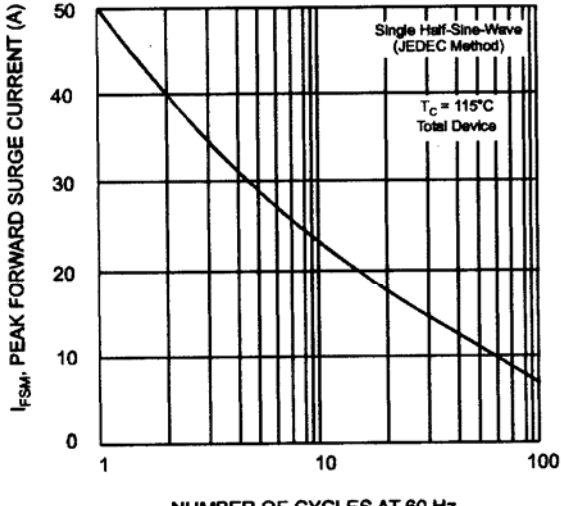
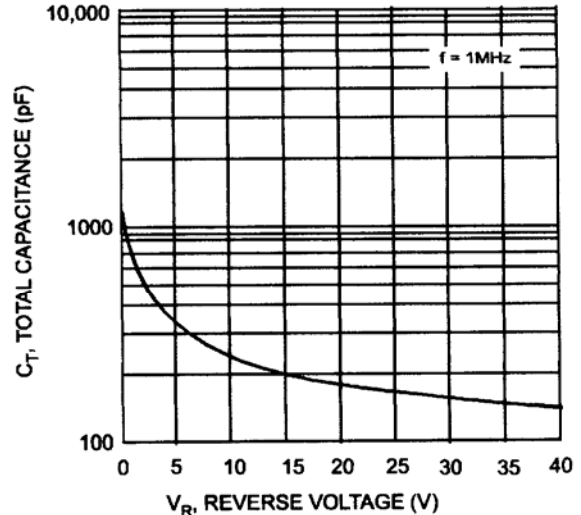
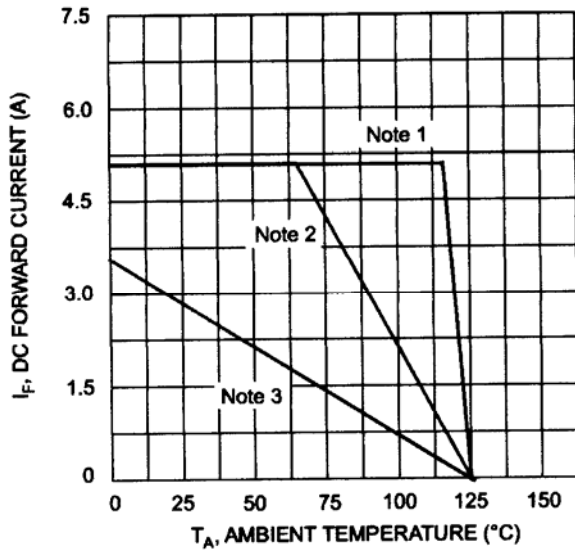
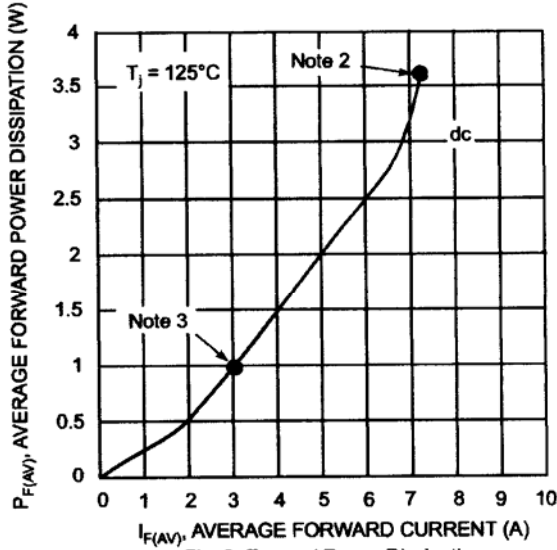
Note: 1 Short duration test pulse used to minimize self-heating effect

**GRAPHS**


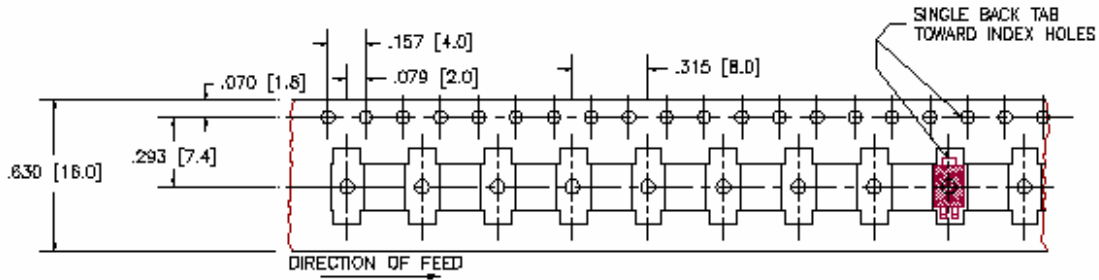
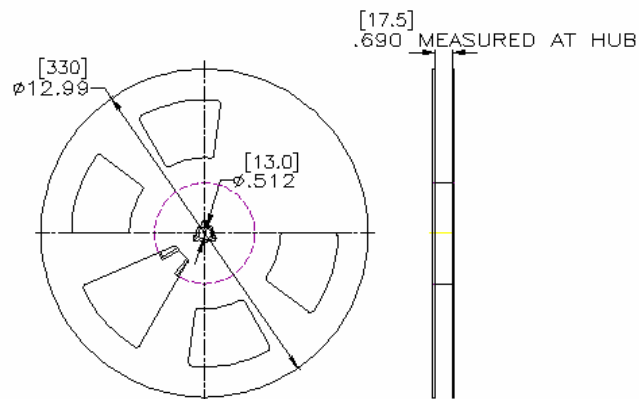
$V_F$ , INSTANTANEOUS FORWARD VOLTAGE (mV)  
Fig. 1 Typical Forward Characteristics, Per Element



$V_R$ , INSTANTANEOUS REVERSE VOLTAGE (V)  
Fig. 2 Typical Reverse Characteristics, Per Element

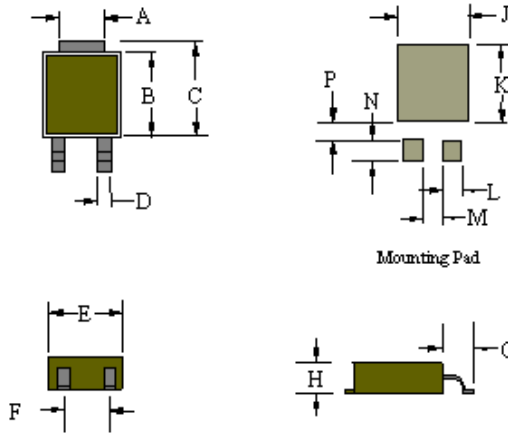

**Fig. 3 Max Non-Repetitive Peak Fwd Surge Current**

**Fig. 4 Typical Capacitance vs. Reverse Voltage, Per Element**

**Fig. 5 DC Forward Current Derating**

**Fig. 6 Forward Power Dissipation**

- NOTE 1:  $T_A = T_C$  at case bottom where  $R_{\theta JC} = 2.5^\circ \text{C/W}$  (dual device) and  $R_{\theta CA} = 0^\circ \text{C/W}$  (infinite heat sink).
- NOTE 2: Device mounted on GETEK substrate, 2" x 2", 2 oz. copper, double-sided, cathode pad dimensions 0.75" x 1.0", anode pad dimensions 0.25" x 1.0".  $R_{\theta JA}$  in range of 20-35° C/W.
- NOTE 3: Device mounted on FRA-4 substrate, 2" x 2", 2 oz. copper, single-sided, pad layout  $R_{\theta JA}$  in range of 65° C/W. See mounting pad dimensions on page 5.

**TAPE & REEL****16 mm TAPE****13 INCH REEL**

**PACKAGE & PAD LAYOUT DIMENSIONS**
**PACKAGING:**

DIM	INCHES	MILLIMETERS
	NOMINAL	NOMINAL
A	0.070	1.778
B	0.173	4.392
C	0.200	5.080
D	0.035	0.889
E	0.160	4.064
F	0.072	1.829
G	0.056	1.422
H	0.044	1.118
J	0.190	4.826
K	0.210	5.344
L	0.038	0.965
M	0.034	0.864
N	0.030	0.762
P	0.030	0.762





UPS1040CTe3

10 A Dual Schottky Barrier Rectifiers

NOTES: