

DG300A, DG301A DG302A, DG303A

TTL Compatible
CMOS Analog Switches

December 1993

Features

- Low Power Consumption
- Break-Before-Make Switching t_{OFF} 130ns, t_{ON} 150ns Typical
- TTL, CMOS Compatible
- Low $R_{DS(ON)}$ ($\leq 50\Omega$)
- Single Supply Operation
- True Second Source

Description

The DG300A through DG303A family of monolithic CMOS switches are truly compatible second source of the original manufacturer. The switches are latch-proof and are designed to block signals up to $30V_{P-P}$ when OFF. Featuring low leakage and low power consumption, these switches are ideally suited for precision application in instrumentation, communication, data acquisition and battery powered applications. Other key features include Break-Before-Make switching, TTL and CMOS compatibility, and low ON resistance. Single supply operation (for positive switch voltages) is possible by connecting V- to 0V.

Ordering Information

PART NUMBER	TEMPERATURE	PACKAGE
DG300AAK	-55°C to +125°C	14 Lead Ceramic DIP
DG301AAK	-55°C to +125°C	14 Lead Ceramic DIP
DG302AAK	-55°C to +125°C	14 Lead Ceramic DIP
DG303AAK	-55°C to +125°C	14 Lead Ceramic DIP
DG300ABK	-25°C to +85°C	14 Lead Ceramic DIP
DG301ABK	-25°C to +85°C	14 Lead Ceramic DIP
DG302ABK	-25°C to +85°C	14 Lead Ceramic DIP
DG303ABK	-25°C to +85°C	14 Lead Ceramic DIP
DG300ACK	0°C to +70°C	14 Lead Ceramic DIP
DG301ACK	0°C to +70°C	14 Lead Ceramic DIP
DG302ACK	0°C to +70°C	14 Lead Ceramic DIP
DG303ACK	0°C to +70°C	14 Lead Ceramic DIP
DG300ACJ	0°C to +70°C	14 Lead Plastic DIP
DG301ACJ	0°C to +70°C	14 Lead Plastic DIP

PART NUMBER	TEMPERATURE	PACKAGE
DG302ACJ	0°C to +70°C	14 Lead Plastic DIP
DG303ACJ	0°C to +70°C	14 Lead Plastic DIP
DG300AAA	-55°C to +125°C	10 Pin Metal Can
DG301AAA	-55°C to +125°C	10 Pin Metal Can
DG300ABA	-25°C to +85°C	10 Pin Metal Can
DG301ABA	-25°C to +85°C	10 Pin Metal Can
DG300ACA	0°C to +70°C	10 Pin Metal Can
DG301ACA	0°C to +70°C	10 Pin Metal Can
DG303ACY	0°C to +70°C	16 Lead SOIC (W)
DG300AAA/883B	-55°C to +125°C	10 Pin Metal Can
DG300AAK/883B	-55°C to +125°C	14 Lead Ceramic DIP
DG301AAA/883B	-55°C to +125°C	10 Pin Metal Can
DG301AAK/883B	-55°C to +125°C	14 Lead Ceramic DIP
DG302AAK/883B	-55°C to +125°C	14 Lead Ceramic DIP
DG303AAK/883B	-55°C to +125°C	14 Lead Ceramic DIP

Pinouts and Functional Diagrams

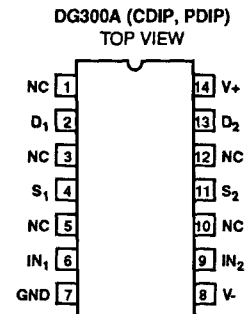
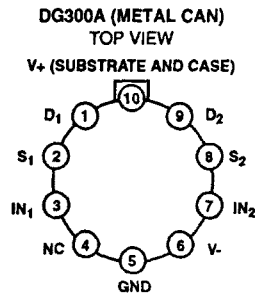
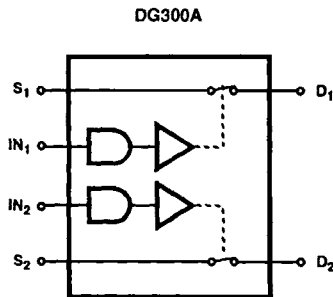

TRUTH TABLE

LOGIC	SWITCH
0	OFF
1	ON

Logic "0" $\leq 0.8V$, Logic "1" $\geq 4.0V$; Two SPST switches per package (switches shown for Logic "1" input)

DG300A, DG301A, DG302A, DG303A

Pinouts and Functional Diagrams (Continued)

DG301A

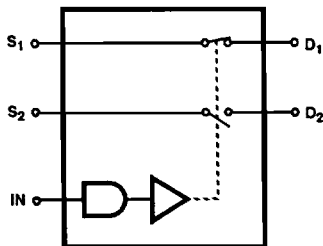

DG301A (METAL CAN)
TOP VIEW

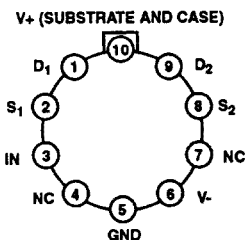

DG301A (CDIP, PDIP)
TOP VIEW

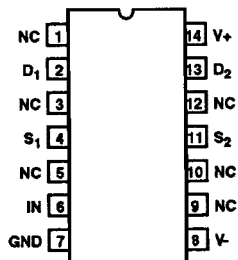

TRUTH TABLE

LOGIC	SWITCH 1	SWITCH 2
0	OFF	ON
1	ON	OFF

Logic "0" $\leq 0.8V$, Logic "1" $\geq 4.0V$; One SPDT switch per package (switches shown for Logic "1" input)

DG302A

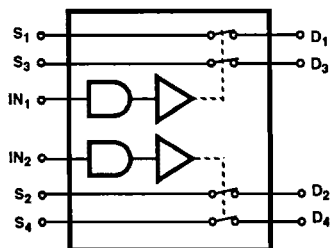

TRUTH TABLE

LOGIC	SWITCH
0	OFF
1	ON

Logic "0" $\leq 0.8V$, Logic "1" $\geq 4.0V$;
Two DPST switch per package (switches shown for Logic "1" input)

DG302A (CDIP, PDIP)
TOP VIEW

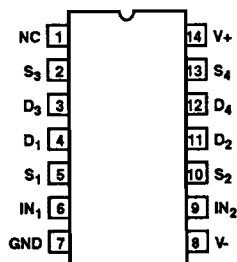

DG303A

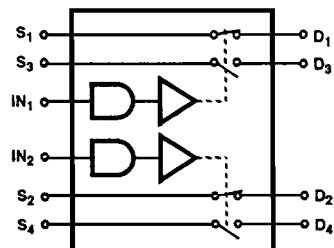

DG303A (CDIP, PDIP)
TOP VIEW

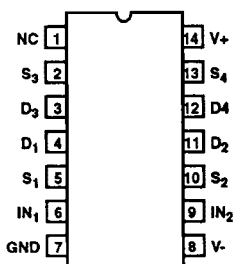

DG303ACY (SOIC)
TOP VIEW

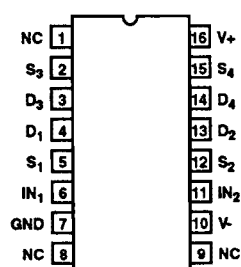

TRUTH TABLE

LOGIC	SWITCH 1 AND 2	SWITCH 3 AND 4
0	OFF	ON
1	ON	OFF

Logic "0" $\leq 0.8V$, Logic "1" $\geq 4.0V$; Two SPDT switch per package (switches shown for Logic "1" input)

Specifications DG300A, DG301A, DG302A, DG303A

Absolute Maximum Ratings

V+ to V-+44.0V
V- to GND-25V
V _{IN} to Ground (Note 1) (V- - 2V), (V+ + 2V)
V _S or V _D to V+ (Note 1)+2, (V- - 2V)
V _S or V _D to V- (Note 1)-2, (V+ + 2V)
Current, Any Terminal Except S or D30mA
Continuous Current, S or D30mA
Peak Current, S or D (Pulsed at 1ms, 10% Duty Cycle Max)100mA
Storage Temperature Range (C Suffix)-65°C to +125°C
(A & B Suffix)-65°C to +150°C
Lead Temperature (Soldering, 10s)300°C

Thermal Information

Thermal Resistance	θ_{JA}	θ_{JC}
SOIC	100°C/W	-
Plastic DIP	145°C/W	-
Ceramic DIP	80°C/W	24°C/W
Metal Can	136°C/W	65°C/W
Junction Temperature		
Ceramic DIP, Metal Can+175°C	
Plastic DIP, SOIC+150°C	

CAUTION: Stresses above those listed in "Absolute Maximum Ratings" may cause permanent damage to the device. This is a stress only rating and operation of the device at these or any other conditions above those indicated in the operational sections of this specification is not implied.

Operating Conditions

Operating Voltage Range ±15V	Input Low Voltage0.8V MAX
Operating Temperature Range (C Suffix)0°C to +70°C	Input High Voltage4.0V MIN
(B Suffix)-25°C to +85°C	Input Rise and Fall Time<20ns
(A Suffix)-55°C to +125°C		

Electrical Specifications V+ = +15V, V- = -15V, GND = 0V, T_A = +25°C

PARAMETER	TEST CONDITION	DG300A - DG303AA			DG300A - DG303AB/C			UNITS	
		MIN	(NOTE 6) TYP	MAX	MIN	(NOTE 6) TYP	MAX		
DYNAMIC CHARACTERISTICS									
Turn-ON Time, t _{ON}	See Figure 3	-	150	300	-	150	-	ns	
Turn-OFF Time, t _{OFF}	See Figure 3	-	130	250	-	130	-	ns	
Break-Before-Make Interval, t _{ON} - t _{OFF}	See Figure 2, DG301A/DG303A	-	50	-	-	50	-	ns	
Charge Injection, Q	C _L = 10nF, R _S = 0, V _S = 0	-	3	-	-	3	-	mV	
Source OFF Capacitance, C _{S(OFF)}	f = 1MHz, V _{IN} = 0.8V or V _{IN} = 4.0V	V _S = 0	-	14	-	-	14	-	pF
Drain OFF Capacitance, C _{D(OFF)}		V _D = 0	-	14	-	-	14	-	pF
Channel ON Capacitance, C _{D(ON)} + C _{S(ON)}		V _S = V _D = 0	-	40	-	-	40	-	pF
Input Capacitance, C _{IN}	f = 1MHz	V _{IN} = 0	-	6	-	-	6	-	pF
		V _{IN} = 15V	-	7	-	-	7	-	pF
OFF Isolation (Note 8)	V _{IN} = 0, R _L = 1k, V _S = 1V _{RMS} , f = 500kHz	-	62	-	-	62	-	dB	
Crosstalk (Channel-to-Channel)		-	74	-	-	74	-	dB	
INPUT									
Input Current with Voltage High, I _{INH}	V _{IN} = 5.0V	-1	-0.001	-	-1	-0.001	-	μA	
	V _{IN} = 15.0V	-	0.001	1	-	0.001	1	μA	
Input Current with Voltage Low, I _{INL}	V _{IN} = 0V	-1	-0.001	-	-1	-0.001	-	μA	
ANALOG SWITCH									
Analog Signal Range, V _{ANALOG}	I _S = 10mA, V _{IN} = 0.8V or 4V	-15	-	15	-15	-	15	V	

Specifications DG300A, DG301A, DG302A, DG303A

Electrical Specifications $V_+ = +15V$, $V_- = -15V$, $GND = 0V$, $T_A = +25^\circ C$ (Continued)

PARAMETER	TEST CONDITION		DG300A - DG303AA			DG300A - DG303AB/C			UNITS
			MIN	(NOTE 6) TYP	MAX	MIN	(NOTE 6) TYP	MAX	
Drain-Source ON Resistance, $R_{DS(ON)}$	$V_{IN} = 0.8V$ or $V_{IN} = 4.0V$	$I_S = -10mA$, $V_D = 10V$	-	30	50	-	30	50	Ω
		$I_S = 10mA$, $V_D = -10V$	-	30	50	-	30	50	Ω
Source OFF Leakage Current, $I_{S(OFF)}$	$V_{IN} = 0.8V$ or $V_{IN} = 4.0V$	$V_S = 14V$, $V_D = -14V$	-	0.1	1	-	0.1	5	nA
		$V_S = -14V$, $V_D = 14V$	-1	-0.1	-	-5	-0.1	-	nA
Drain OFF Leakage Current, $I_{D(OFF)}$	$V_{IN} = 0.8V$ or $V_{IN} = 4.0V$	$V_S = -14V$, $V_D = 14V$	-	0.1	1	-	0.1	5	nA
		$V_S = 14V$, $V_D = -14V$	-1	-0.1	-	-5	-0.1	-	nA
Drain ON Leakage Current, $I_{D(ON)}$	$V_{IN} = 0.8V$ or $V_{IN} = 4.0V$	$V_D = V_S = 14V$	-	0.1	1	-	0.1	5	nA
		$V_D = V_S = -14V$	-2	-0.1	-	-5	-0.1	-	nA
POWER SUPPLIES									
Positive Supply Current, I_+	$V_{IN} = 4V$ (One Input) (All Others = 0)		-	0.23	0.5	-	0.23	0.5	mA
Negative Supply Current, I_-			-10	-0.001	-	-10	-0.001	-	μA
Positive Supply Current, I_+	$V_{IN} = 0.8V$ (All Inputs)		-	0.001	10	-	0.001	10	μA
Negative Supply Current, I_-			-10	-0.001	-	-10	-0.001	-	μA

Electrical Specifications $V_+ = +15V$, $V_- = -15V$, $GND = 0V$, $T_A =$ Over Temperature Range

PARAMETER	TEST CONDITION		DG300A - DG303AA			DG300A - DG303AB/C			UNITS
			MIN	(NOTE 6) TYP	MAX	MIN	(NOTE 6) TYP	MAX	
INPUT									
Input Current with Voltage High, I_{INH}	$V_{IN} = 5.0V$		-1	-	-	-	-	-	μA
	$V_{IN} = 15.0V$		-	-	1	-	-	-	μA
Input Current with Voltage Low, I_{INL}	$V_{IN} = 0V$		-1	-	-	-	-	-	μA
ANALOG SWITCH									
Analog Signal Range, V_{ANALOG}	$I_S = 10mA$, $V_{IN} = 0.8V$ or $4V$		-15	-	15	-15	-	15	V
Drain-Source ON Resistance, $R_{DS(ON)}$	$V_{IN} = 0.8V$ or $V_{IN} = 4.0V$	$I_S = -10mA$, $V_D = 10V$	-	-	75	-	-	75	Ω
		$I_S = 10mA$, $V_D = -10V$	-	-	75	-	-	75	Ω
Source OFF Leakage Current, $I_{S(OFF)}$	$V_{IN} = 0.8V$ or $V_{IN} = 4.0V$	$V_S = 14V$, $V_D = -14V$	-	-	100	-	-	100	nA
		$V_S = -14V$, $V_D = 14V$	-100	-	-	-100	-	-	nA
Drain OFF Leakage Current, $I_{D(OFF)}$	$V_{IN} = 0.8V$ or $V_{IN} = 4.0V$	$V_S = -14V$, $V_D = 14V$	-	-	100	-	-	100	nA
		$V_S = 14V$, $V_D = -14V$	-100	-	-	-100	-	-	nA
Drain ON Leakage Current, $I_{D(ON)}$	$V_{IN} = 0.8V$ or $V_{IN} = 4.0V$	$V_D = V_S = 14V$	-	-	100	-	-	100	nA
		$V_D = V_S = -14V$	-200	-	-	-200	-	-	nA

Specifications DG300A, DG301A, DG302A, DG303A

Electrical Specifications $V_+ = +15V$, $V_- = -15V$, $GND = 0V$, $T_A =$ Over Temperature Range (Continued)

PARAMETER	TEST CONDITION	DG300A - DG303AA			DG300A - DG303AB/C			UNITS
		MIN	(NOTE 6) TYP	MAX	MIN	(NOTE 6) TYP	MAX	
POWER SUPPLIES								
Positive Supply Current, I_+	$V_{IN} = 4V$ (One Input) (All Others = 0)	-	-	1	-	-	-	mA
Negative Supply Current, I_-		-100	-	-	-	-	-	μA
Positive Supply Current, I_+	$V_{IN} = 0.8V$ (All Inputs)	-	-	100	-	-	-	μA
Negative Supply Current, I_-		-100	-	-	-	-	-	μA

NOTES:

1. Signals on V_S , V_D or V_{IN} exceeding V_+ or V_- will be clamped by internal diodes. Limit diode toward current to maximum current ratings.
2. Device mounted with all leads soldered or welded to PC board.
3. Derate 11mW/°C above +75°C
4. Derate 6.5mW/°C above +25°C.
5. Derate 6mW/°C above +75°C.
6. For design only, not 100% tested.
7. The algebraic convention whereby the most negative value is a minimum, and the most positive value is a maximum, is used in this data sheet.
8. OFF isolation = 20 log V_S/V_D , where V_S = input to OFF switch, and V_D = output.

Pin Description

PIN	SYMBOL	DESCRIPTION
DG300A		
1	NC	No Connection
2	D_1	Drain (Output) terminal for Switch 1
3	NC	No Connection
4	S_1	Source (Input) terminal for Switch 1
5	NC	No Connection
6	IN_1	Logic Control for Switch 1
7	GND	Ground Terminal (Logic Common)
8	V_-	Negative Power Supply Terminal
9	IN_2	Logic Control for Switch 2
10	NC	No Connection
11	NC	No Connection
12	S_2	Source (Input) terminal for Switch 2
13	D_2	Drain (Output) terminal for Switch 2
14	V_+	Positive Power Supply Terminal
DG301A		
1	NC	No Connection
2	D_1	Drain (Output) terminal for Switch 1
3	NC	No Connection
4	S_1	Source (Input) terminal for Switch 1
5	IN	Logic Control for Switches
6	GND	Ground Terminal (Logic Common)
7	V_-	Negative Power Supply Terminal

PIN	SYMBOL	DESCRIPTION
8	NC	No Connection
9	NC	No Connection
10	S_2	Source (Input) terminal for Switch 2
11	NC	No Connection
12	D_2	Drain (Output) terminal for Switch 2
13	NC	No Connection
14	V_+	Positive Power Supply Terminal
DG302A, DG303A		
1	NC	No Connection
2	S_3	Source (Input) terminal for Switch 3
3	D_3	Drain (Output) terminal for Switch 3
4	D_1	Drain (Output) terminal for Switch 1
5	S_1	Source (Input) terminal for Switch 1
6	IN_1	Logic Control for Switch 1
7	GND	Ground Terminal (Logic Common)
8	V_-	Negative Power Supply Terminal
9	IN_2	Logic Control for Switch 2
10	S_2	Source (Input) terminal for Switch 2
11	D_2	Drain (Output) terminal for Switch 2
12	D_4	Drain (Output) terminal for Switch 4
13	S_4	Source (Input) terminal for Switch 4
14	V_+	Positive Power Supply Terminal

Test Circuits

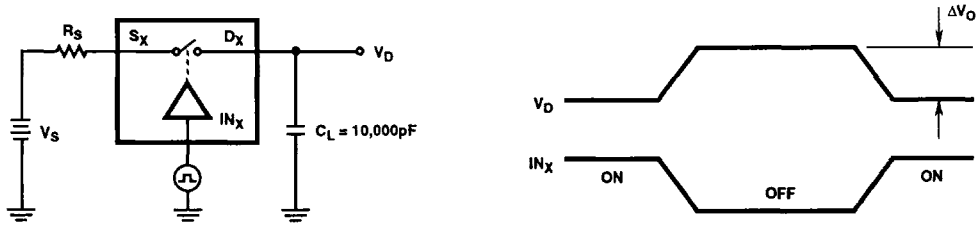

FIGURE 1. CHARGE INJECTION TEST CIRCUIT

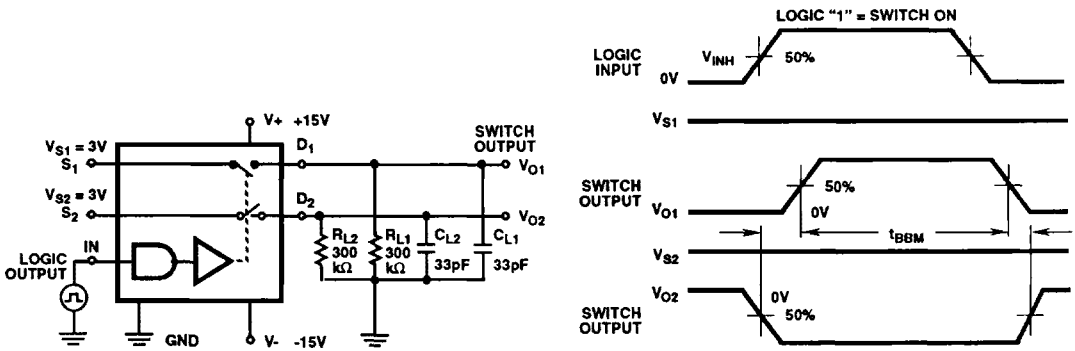

FIGURE 2. BREAK-BEFORE MAKE TEST CIRCUIT (DG301A, DG303A)

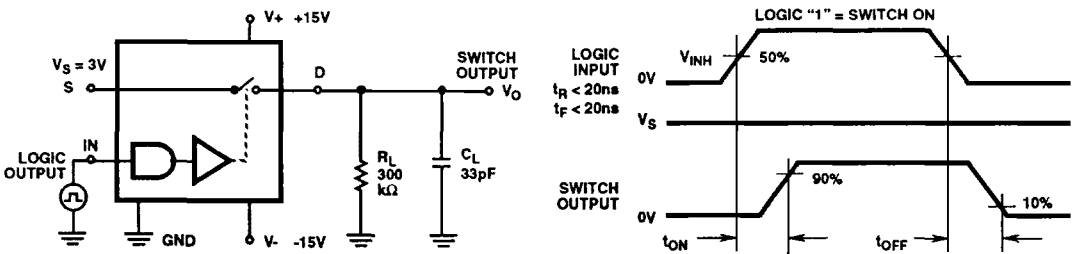

FIGURE 3. t_{ON} and t_{OFF} TEST CIRCUIT

DG300A, DG301A, DG302A, DG303A

Die Characteristics

DIE DIMENSIONS:

89 x 99 x 12 ± 2mils

METALLIZATION:

Type: Al

Thickness: 10kÅ ± 1kÅ

GLASSIVATION:

Type: PSG Over Nitride

PSG Thickness: 7kÅ ± 1.4kÅ

Nitride Thickness: 8kÅ ± 1.2kÅ

WORST CASE CURRENT DENSITY:

1 x 10⁵ A/cm²

Metallization Mask Layout

