

# 1 • ROW Strip Connectors Board to Cable

.050"

**MA-1**

2 thru 60 Contacts

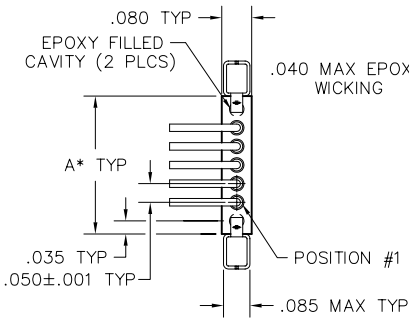

TERMINATION VIEW

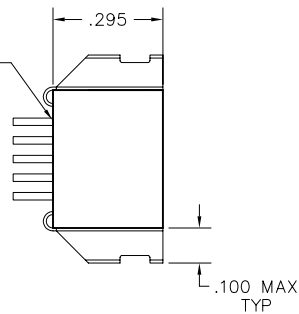

PLUG

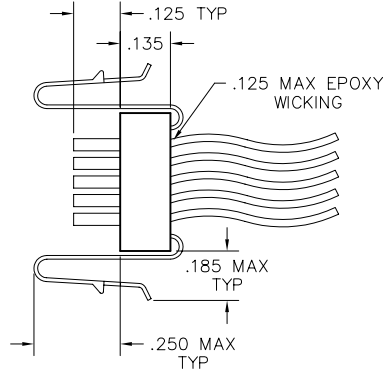

RECEPTACLE

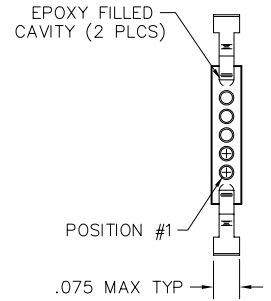

TERMINATION VIEW

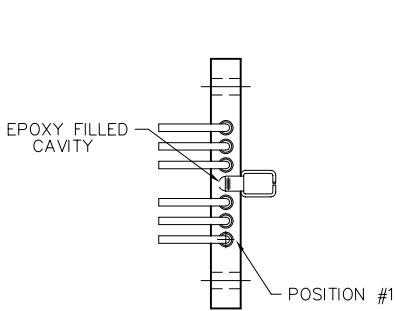

TERMINATION VIEW

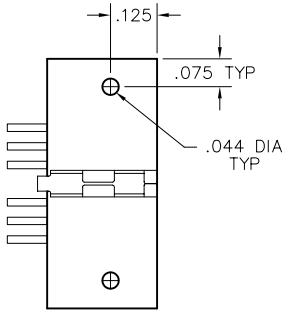

PLUG

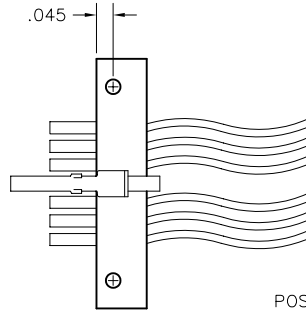

POSITION #1

TERMINATION VIEW

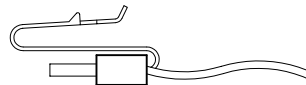

RECEPTACLE

OPTIONAL MOUNTING HOLES

DIMENSIONS

To determine connector length (Dim "A");	
Multiply the number of cavities in one row by .050"	. "
Add fixed end lengths (constant, .010" x 2)	0.02"
Add .150" for each mounting hole	. "
Total Length:	. "

Notes:

Length over 2" may require support to insure alignment.  
 When using one lock screw, use centermost available hole.  
 \* = Maximum length is 3.020". Maximum number of contacts must be reduced to accommodate hardware and mounting holes.

**LEAD CONFIGURATION OPTIONS**

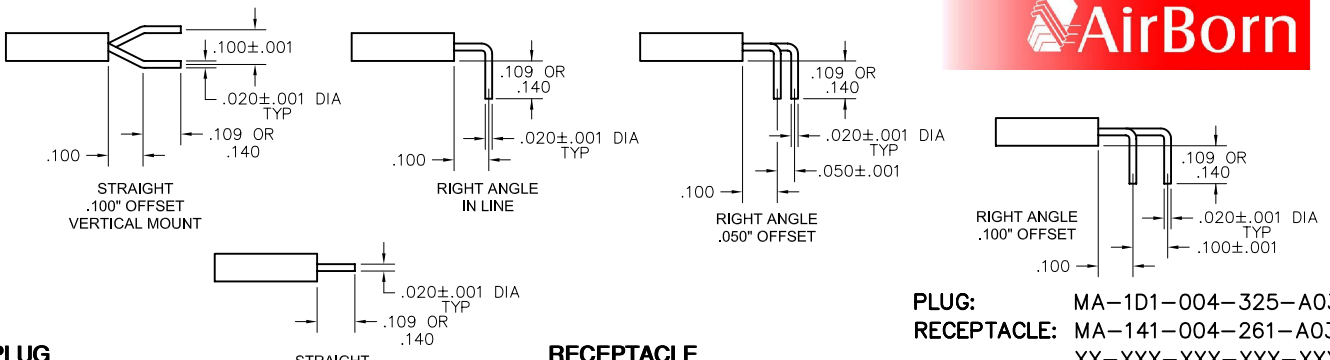

**PLUG:** MA-1D1-004-325-A0300  
**RECEPTACLE:** MA-141-004-261-A03WS  
 XX-XXX-XXX-XXX-XXXXX

<b>PLUG</b>		<b>RECEPTACLE</b>	
<b>SERIES</b>			
MA .050" Microminiature Strip Connector		MA .050" Microminiature Strip Connector	
<b>BODY</b>			
1 1-Row	1 1-Row	1 1-Row	1 1-Row
BODY STYLE: (Material: Polyphenylene sulfide)		BODY STYLE: (Material: Polyphenylene sulfide)	
11 Plug, straight, with mounting holes	21 Receptacle, straight, with mounting holes	31 Plug, straight, without mounting holes	41 Receptacle, straight, without mounting holes
51 Plug, right angle, .050" offset, with mounting holes	61 Receptacle, right angle, .050" offset, with mounting holes	71 Plug, right angle, .100" offset, with mounting holes	81 Receptacle, right angle, .100" offset, with mounting holes
91 Plug, right angle, .050" offset, without mounting holes	A1 Receptacle, right angle, .050" offset, without mounting holes	B1 Plug, right angle, .100" offset, without mounting holes	C1 Receptacle, right angle, .100" offset, without mounting holes
D1 Plug, right angle, in line, with mounting holes	E1 Receptacle, right angle, in line, with mounting holes	F1 Plug, right angle, in line, without mounting holes	G1 Receptacle, right angle, in line, without mounting holes
H1 Plug, straight, .100" offset, without mounting holes	J1 Receptacle, straight, .100" offset, without mounting holes		
<b>SIZE</b>			
XXX 002 - 060		XXX 002 - 060	
Note: Maximum number of contacts is reduced when using hardware or mounting holes. See dimension chart on M-13.			
<b>CONTACTS</b>			
TYPE CONTACTS/TERMINATIONS:		TYPE CONTACTS/TERMINATIONS:	
11 Pin, straight, solder cup	21 Socket, straight, solder cup	12 Pin, straight, PCB leads, .109"	22 Socket, straight, PCB leads, .109"
13 Pin, straight, PCB leads, .140"	23 Socket, straight, PCB leads, .140"	14 Pin, straight, .500" pigtails (.018 dia)	24 Socket, straight, .500" pigtails (.018 dia)
15 Pin, straight, 1.000" pigtails (.018 dia)	25 Socket, straight, 1.000" pigtails (.018 dia)	16 Pin, straight, crimped wire	26 Socket, straight, crimped wire
32 Pin, right angle, PCB leads, .109"	43 Socket, right angle, PCB leads, .109"	33 Pin, right angle, PCB leads, .140"	44 Socket, right angle, PCB leads, .140"
PLATING OPTIONS:		PLATING OPTIONS:	
1 50 μ" Au contacts (crimp wire)	1 50 μ" Au contacts (crimp wire)	3 50 μ" Au contacts; 10 μ" Au terminations (solder cup, pigtail, PCB leads)	3 50 μ" Au contacts; 10 μ" Au terminations (solder cup, pigtail, PCB leads)
5 50 μ" Au contacts; Sn/Pb alloy terminations (dip solder, pigtail, PCB leads) ☒	5 50 μ" Au contacts; Sn/Pb alloy terminations (dip solder, pigtail, PCB leads) ☒	7 50 μ" Au contacts; SAC305 terminations (pigtail, PCB leads)	7 50 μ" Au contacts; SAC305 terminations (pigtail, PCB leads)
<b>HARDWARE</b>			
STYLE OF HARDWARE:		STYLE OF HARDWARE:	
A00 None	A00 None	A01-A49 Latch box, side mounted (cavity number location)	A01-A49 Latch spring, side mounted (cavity number location)
A50 Latch boxes (two end cavities)**	A51 Latch springs (two end cavities)**	A64 One guide hole (centered)*	A61 One guide pin (centered)*
A65 One guide hole (first cavity)	A62 One guide pin (first cavity)	A66 One guide hole (last cavity)	A63 One guide pin (last cavity)
A68 Two guide holes (two end cavities)	A67 Two guide pins (two end cavities)	A69 One threaded hole (centered)*	A72 One lockscrew (centered)*
AHX One guide hole (cavity #2 - #9)	APX One guide pin (cavity #2 - #9)	ATX One threaded hole (cavity #2 - #9)	ALX One lockscrew (cavity #2 - #9)
POLARIZATION / WIRING:		POLARIZATION / WIRING:	
00 None	00 None	XX For wiring codes, see pages MA-3 & MA-4	XX For wiring codes, see pages MA-3 & MA-4

\* = To determine location, divide the total number of cavities by two and round to the next whole number, if result is a fraction. See page M-15.  
 \*\* = Not available with mounting holes.  
 See MA strip guidelines, page M-15, for location examples & visual clarification.  
 ☒ = Option not RoHS compliant

## Wire Codes

### NEMA HP3-EXBEB (Formerly M16878/4-24 TFE 7 strand)

	6"	12"	18"	24"	30"	36"	42"	48"	54"	60"	66"	72"	84"	96"	108"	120"
MIL-STD-681*	WA	WB	WC	UD	UE	WD	UG	UH	UJ	UK	UL	UM	UN	UP	UQ	UR
WHITE	WE	WF	WG	VD	VE	WH	VG	VH	VJ	VK	VL	VM	VN	VP	VQ	VR
YELLOW	WJ	WK	WL			WM										

### NEMA HP3-EXBDB (Formerly M16878/4-26 TFE 7 strand)

	6"	12"	18"	24"	30"	36"	42"	48"	54"	60"	66"	72"	84"	96"	108"	120"
MIL-STD-681*	WN	WP	WQ	YD	YE	WR	YG	YH	YJ	YK	YL	YM	YN	YP	YQ	YR
WHITE	WS	WT	WU	ZD	ZE	WV	ZG	ZH	ZJ	ZK	ZL	ZM	ZN	ZP	ZQ	ZR
YELLOW	WW	WX	WY			WZ										

### NEMA HP3-EXBCB (Formerly M16878/4-28 TFE 7 strand)

	6"	12"	18"	24"	30"	36"	42"	48"	54"	60"	66"	72"	84"	96"	108"	120"
MIL-STD-681*	XA	XB	XC	1D	1E	XD	1G	1H	1J	1K	1L	1M	1N	1P	1Q	1R
WHITE	XE	XF	XG	2D	2E	XH	2G	2H	2J	2K	2L	2M	2N	2P	2Q	2R
YELLOW	XJ	XK	XL			XM										

### TWISTED PAIR per NEMA WC27500-XXRC2U00 (SAE AS22759/11)

	6"	12"	18"	24"	30"	36"	42"	48"	54"	60"	66"	72"	84"	96"	108"	120"
24 AWG	AA	AB	AC	AD	AE	AF	AG	AH	AJ	AK	AL	AM	AN	AP	AQ	AR
26 AWG	BA	BB	BC	BD	BE	BF	BG	BH	BJ	BK	BL	BM	BN	BP	BQ	BR

### TWISTED PAIR per NEMA WC27500-XXSC2U00 (SAE AS22759/33)\*\*\* ☒

	6"	12"	18"	24"	30"	36"	42"	48"	54"	60"	66"	72"	84"	96"	108"	120"
24 AWG	JA	JB	JC	JD	JE	JF	JG	JH	JJ	JK	JL	JM	JN	JP	JQ	JR
26 AWG	KA	KB	KC	KD	KE	KF	KG	KH	KJ	KK	KL	KM	KN	KP	KQ	KR

For twisted pair wire connect charts, see page MA-9  
Twisted pair wire not available on MA, MC or Hybrid connectors

\* = Connectors with more than 100 contacts will repeat color code after 100 colors.

\*\*\* = Per M83513, corrosion has been experienced on connectors that are pre-wired with 22759/33 and stored in sealed environments. Caution should be exercised when using this wire.

☒ = Option not RoHS compliant

## Wire Codes

### SAE AS22759/11-24

	6"	12"	18"	24"	30"	36"	42"	48"	54"	60"	66"	72"	84"	96"	108"	120"
M83513**	5A	5B	5C	5D	5E	5F	5G	5H	5J	5K	5L	5M	5N	5P	5Q	5R
MIL-STD-681*	CA	CB	CC	CD	CE	CF	CG	CH	CJ	CK	CL	CM	CN	CP	CQ	CR
WHITE	DA	DB	DC	DD	DE	DF	DG	DH	DJ	DK	DL	DM	DN	DP	DQ	DR

### SAE AS22759/11-26

	6"	12"	18"	24"	30"	36"	42"	48"	54"	60"	66"	72"	84"	96"	108"	120"
M83513**	6A	6B	V1	6D	6E	V2	6G	6H	6J	6K	6L	Y6	6N	6P	6Q	6R
MIL-STD-681*	X3	X4	W3	ED	EE	W4	EG	EH	EJ	EK	EL	EM	EN	EP	EQ	ER
WHITE	X1	X2	W1	FD	FE	W2	FG	FH	FJ	FK	FL	Y5	FN	FP	FQ	FR

### SAE AS22759/33-24\*\*\* ☒

	6"	12"	18"	24"	30"	36"	42"	48"	54"	60"	66"	72"	84"	96"	108"	120"
M83513**	LA	LB	LC	LD	LE	LF	LG	LH	LJ	LK	LL	LM	LN	LP	LQ	LR
WHITE	MA	MB	MC	MD	ME	MF	MG	MH	MJ	MK	ML	MM	MN	MP	MQ	MR

### SAE AS22759/33-26\*\*\* ☒

	6"	12"	18"	24"	30"	36"	42"	48"	54"	60"	66"	72"	84"	96"	108"	120"
M83513**	NA	NB	Y3	ND	NE	Y4	NG	NH	NJ	NK	NL	Y8	NN	NP	NQ	NR
WHITE	PA	PB	Y1	PD	PE	Y2	PG	PH	PJ	PK	PL	Y7	PN	PP	PQ	PR

\* = Connectors with more than 100 contacts will repeat color code after 100 colors.

\*\* = Wire colors per M83513 are ten solid colors repeating.

\*\*\* = Per M83513, corrosion has been experienced on connectors that are pre-wired with 22759/33 and stored in sealed environments.

Caution should be exercised when using this wire.

☒ = Option not RoHS compliant