

Features

- High surge current capability
- Avalanche types available
- Stud cathode and stud anode version
- Wide current range
- Types up to 1200V V_{RRM}

16 A

Typical Applications

- Battery charges
- Converters
- Power supplies
- Machine tool controls

Major Ratings and Characteristics

Parameters	16F(R)	Units
$I_{F(AV)}$	16	A
@ T_C	140	°C
$I_{F(RMS)}$	25	A
I_{FSM} @ 50Hz	350	A
@ 60Hz	370	A
I^2t @ 50Hz	612	A ² s
@ 60Hz	560	A ² s
V_{RRM} range	100 to 1200	V
T_J range	- 65 to 175	°C



16F(R) Series

Bulletin I20204 rev. B 01/05

International
IR Rectifier

ELECTRICAL SPECIFICATIONS

Voltage Ratings

Type number	Voltage Code	V_{RRM} : maximum repetitive peak reverse voltage V	V_{RSM} : maximum non-repetitive peak reverse voltage V	$V_{R(BR)}$: minimum avalanche voltage V (1)	I_{RRM} max. @ $T_J = 175^\circ\text{C}$ mA
16F(R)	10	100	150	--	12
	20	200	275	--	
	40	400	500	500	
	60	600	725	750	
	80	800	950	950	
	100	1000	1200	1150	
	120	1200	1400	1350	

(1) Avalanche version only available from V_{RRM} 400V to 1200V.

Forward Conduction

Parameter	16F(R)	Units	Conditions
$I_{F(AV)}$ Max. average forward current @ Case temperature	16 140	A $^\circ\text{C}$	180° conduction, half sine wave
$I_{F(RMS)}$ Max. RMS forward current	25	A	
P_R Maximum non-repetitive peak reverse power	15	K/W	10µs square pulse, $T_J = T_J$ max. see note (2)
I_{FSM} Max. peak, one-cycle forward, non-repetitive surge current	350	A	t = 10ms No voltage
	370		t = 8.3ms reapplied
	295		t = 10ms 100% V_{RRM}
	310		t = 8.3ms reapplied
I^2t Maximum I^2t for fusing	612	A ² s	t = 10ms No voltage
	560		t = 8.3ms reapplied
	435		t = 10ms 100% V_{RRM}
	395		t = 8.3ms reapplied
$I^2\sqrt{t}$ Maximum $I^2\sqrt{t}$ for fusing	6120	A ² √s	t = 0.1 to 10ms, no voltage reapplied
$V_{F(TO)1}$ Low level value of threshold voltage	0.77	V	$(16.7\% \times \pi \times I_{F(AV)} < I < \pi \times I_{F(AV)})$, $T_J = T_J$ max.
$V_{F(TO)2}$ High level value of threshold voltage	0.90		$(I > \pi \times I_{F(AV)})$, $T_J = T_J$ max.
r_{f1} Low level value of forward slope resistance	7.80	mΩ	$(16.7\% \times \pi \times I_{F(AV)} < I < \pi \times I_{F(AV)})$, $T_J = T_J$ max.
r_{f2} High level value of forward slope resistance	5.70		$(I > \pi \times I_{F(AV)})$, $T_J = T_J$ max.
V_{FM} Max. forward voltage drop	1.23	V	$I_{pk} = 50\text{A}$, $T_J = 25^\circ\text{C}$, $t_p = 400\mu\text{s}$ rectangular wave

(2) Available only for Avalanche version, all other parameters the same as 16F.

Thermal and Mechanical Specifications

Parameter	16F(R)	Units	Conditions
T _J Max. junction operating temperature range	-65 to 175	°C	
T _{stg} Max. storage temperature range	-65 to 200		
R _{thJC} Max. thermal resistance, junction to case	1.6	K/W	DC operation
R _{thCS} Max. thermal resistance, case to heatsink	0.5		Mounting surface, smooth, flat and greased
T Allowable mounting torque	1.5 ^{+0-10%}	Nm	Not lubricated threads
	13	lbf.in	
	1.2 ^{+0-10%}	Nm	Lubricated threads
	10	lbf.in	
wt Approximate weight	7 (0.25)	g (oz)	
Case style	DO-203AA (DO-4)		See Outline Table

ΔR_{thJC} Conduction

(The following table shows the increment of thermal resistance R_{thJC} when devices operate at different conduction angles than DC)

Conduction angle	Sinusoidal conduction	Rectangular conduction	Units	Conditions
180°	0.31	0.23	K/W	T _J = T _J max.
120°	0.38	0.40		
90°	0.49	0.54		
60°	0.72	0.75		
30°	1.20	1.21		

Ordering Information Table

Device Code	
<div style="display: flex; justify-content: space-around; align-items: center;"> <div style="border: 1px solid black; padding: 2px 5px; margin: 0 5px;">A</div> <div style="border: 1px solid black; padding: 2px 5px; margin: 0 5px;">16</div> <div style="border: 1px solid black; padding: 2px 5px; margin: 0 5px;">F</div> <div style="border: 1px solid black; padding: 2px 5px; margin: 0 5px;">R</div> <div style="border: 1px solid black; padding: 2px 5px; margin: 0 5px;">120</div> <div style="border: 1px solid black; padding: 2px 5px; margin: 0 5px;">M</div> </div> <div style="display: flex; justify-content: space-around; margin-top: 5px;"> ① ② ③ ④ ⑤ ⑥ </div>	<p>1 - A = Avalanche diode None = Standard diode</p> <p>2 - Current rating: Code = I_{F(AV)}</p> <p>3 - F = Standard device</p> <p>4 - None = Stud Normal Polarity (Cathode to Stud) R = Stud Reverse Polarity (Anode to Stud)</p> <p>5 - Voltage code: Code x 10 = V_{RRM} (See Voltage Ratings table)</p> <p>6 - None = Stud base DO-203AA (DO-4) 10-32UNF-2A M = Stud base DO-203AA (DO-4) M5 X 0.8 - (Not available for Avalanche diodes)</p>

16F(R) Series

Bulletin I20204 rev. B 01/05

Outlines Table

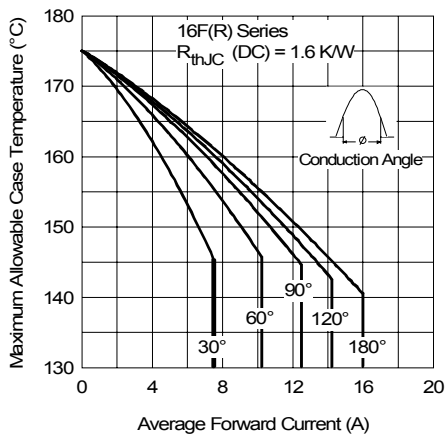
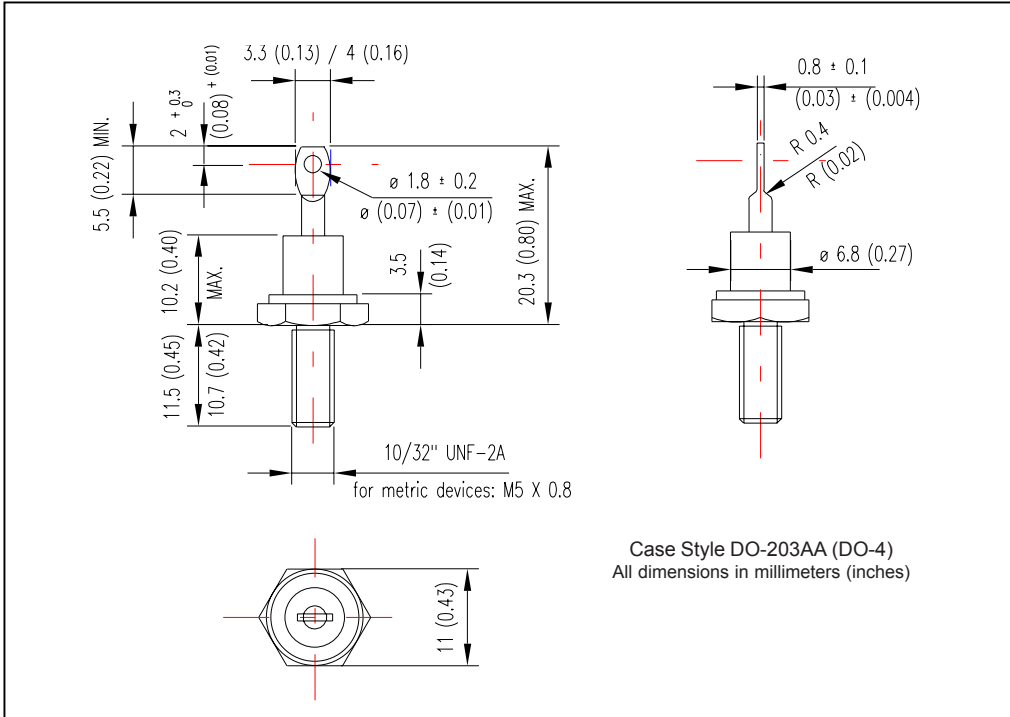

Fig. 1 - Current Ratings Characteristics

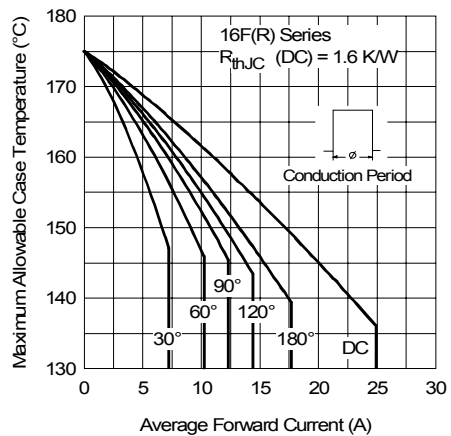

Fig. 2 - Current Ratings Characteristics

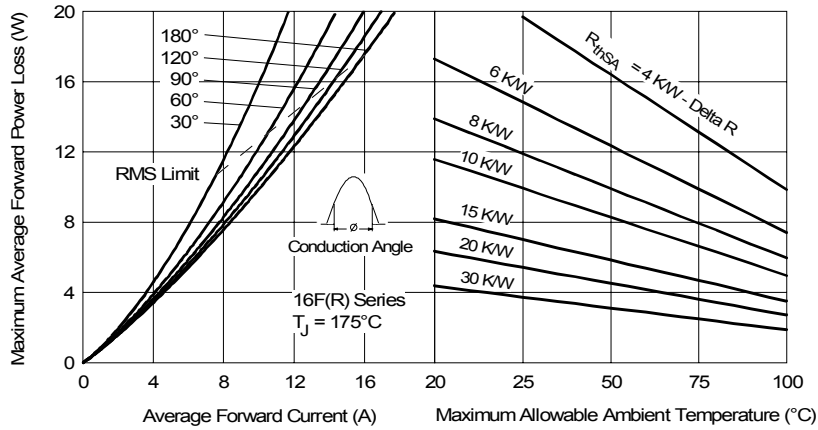

Fig. 3 - Forward Power Loss Characteristics

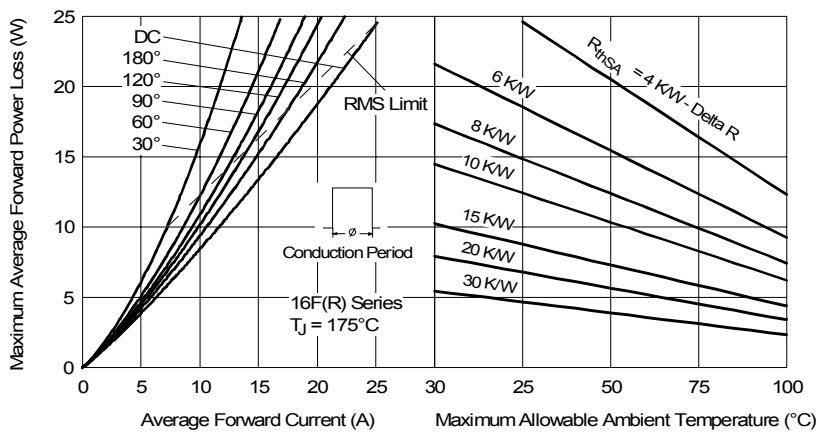

Fig. 4 - Forward Power Loss Characteristics

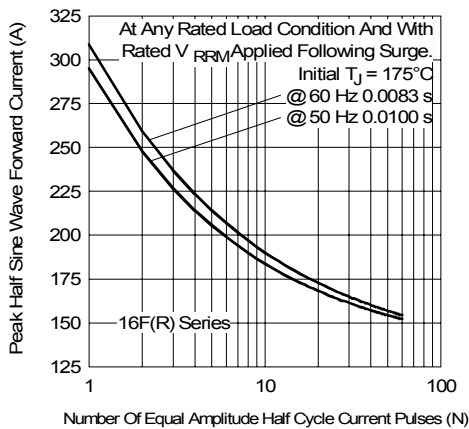

Fig. 5 - Maximum Non-Repetitive Surge Current

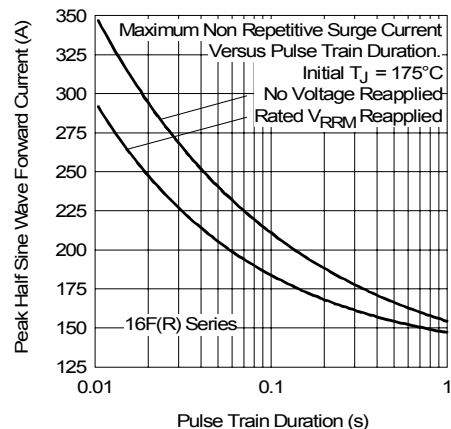

Fig. 6 - Maximum Non-Repetitive Surge Current

16F(R) Series

Bulletin I20204 rev. B 01/05

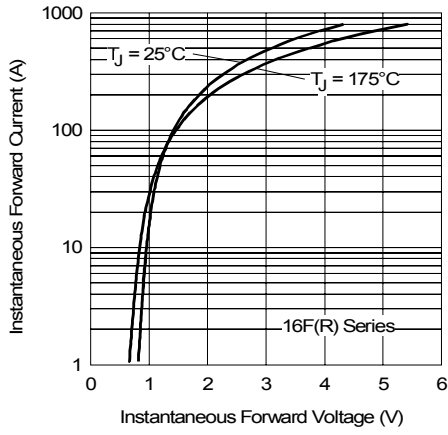

Fig. 7 - Forward Voltage Drop Characteristics

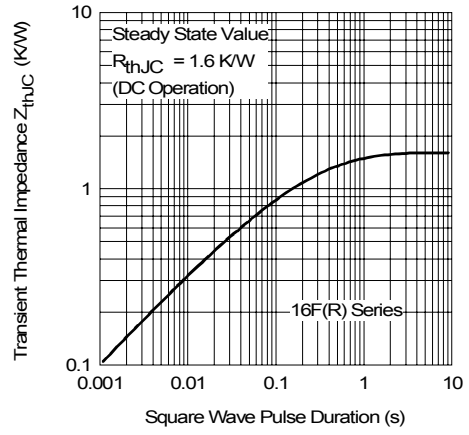

Fig. 8 - Thermal Impedance Z_{thJC} Characteristics