

ICL 8023 NOT RECOMMENDED FOR NEW DESIGNS SEE ICL 7630

ICL8021/ICL8023

Low Power Bipolar Operational Amplifier

GENERAL DESCRIPTION

The Harris ICL8021 series are low power operational amplifiers specifically designed for applications requiring very low standby power consumption over a wide range of supply voltages. The electrical characteristics of the 8021 series can be tailored to a particular application by adjusting an external resistor, R_{SET} , which controls the quiescent current. This is advantageous because I_Q can be made independent of the supply voltages; it can be set to an extremely low value where power is critical, or to a larger value for high slew rate or wideband applications.

Other features of the 8021 series include low input current that remains constant with temperature, low noise, high input impedance, internal compensation and pin-for-pin compatibility with the 741.

The Harris 8023 consists of three low power operational amplifiers in a single 16-pin DIP. Each amplifier is identical to an 8021 low power op amp, and has separate connections for adjusting its electrical characteristics by means of an external resistor, R_{SET} , which controls the quiescent current of that amplifier.

FEATURES

- $V_{OS} = 3mV$ Max (Adjustable to Zero)
- $\pm 1.5V$ to $\pm 18V$ Power Supply Operation
- Power Consumption — $20\mu W$ @ $\pm 1V$
- Input Bias Current — $30nA$ Max
- Internal Compensation
- Pin-For-Pin Compatible With 741
- Short Circuit Protected

ORDERING INFORMATION

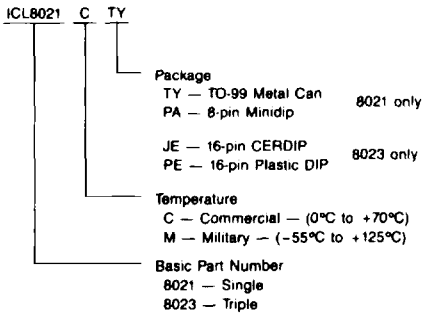

Part Number	Temperature Range	Package
ICL8021CJA	0°C to 70°C	8 Lead CERDIP
ICL8021CBA	0°C to 70°C	8 Lead S.O.I.C
ICL8021CPA	0°C to 70°C	8 Lead MINIDIP
ICL8021CTY	0°C to 70°C	8 Lead Metal Can
ICL8021MJA	-55°C to +125°C	8 Lead CERDIP
ICL8021MTY*	55°C to +125°C	8 Lead Metal Can
ICL8023CJE	0°C to 70°C	16 Lead CERDIP
ICL8023CPE	0°C to 70°C	16 Lead MINIDIP
ICL8023MJE*	55°C to +125°C	16 Lead CERDIP

*Add /88313 to Part Number if 883B processing is required.

0311-20

HARRIS SEMICONDUCTOR'S SOLE AND EXCLUSIVE WARRANTY OBLIGATION WITH RESPECT TO THIS PRODUCT SHALL BE THAT STATED IN THE WARRANTY ARTICLE OF THE CONDITION OF SALE. THE WARRANTY SHALL BE EXCLUSIVE AND SHALL BE IN LIEU OF ALL OTHER WARRANTIES, EXPRESS, IMPLIED OR STATUTORY, INCLUDING THE IMPLIED WARRANTIES OF MERCHANTABILITY AND FITNESS FOR A PARTICULAR USE.

NOTE: All typical values have been characterized but are not tested.

ICL8021/ICL8023

ABSOLUTE MAXIMUM RATINGS

Supply Voltage	$\pm 18V$
Differential Input Voltage (Note 1)	$\pm 15V$
Common Mode Input Voltage (Note 1)	$\pm 15V$
Output Short Circuit Duration	Indefinite
Power Dissipation (Note 2)	300mW

Operating Temperature Range	
8021M/8023M	$-55^{\circ}C$ to $+125^{\circ}C$
8021C/8023C	$0^{\circ}C$ to $+70^{\circ}C$
Storage Temperature Range	$-65^{\circ}C$ to $+150^{\circ}C$
Lead Temperature (Soldering, 10sec)	$+300^{\circ}C$

NOTE 1: For supply voltages less than $\pm 15V$, the absolute maximum input voltage is equal to the supply voltage

NOTE 2: Rating applies for case temperatures to $+125^{\circ}C$; derate linearly at $5.6 \text{ mW}/^{\circ}C$ for ambient temperatures above $+95^{\circ}C$.

NOTE: Stresses above those listed under "Absolute Maximum Ratings" may cause permanent damage to the device. These are stress ratings only and functional operation of the device at these or any other conditions above those indicated in the operational sections of the specifications is not implied. Exposure to absolute maximum rating conditions for extended periods may affect device reliability.

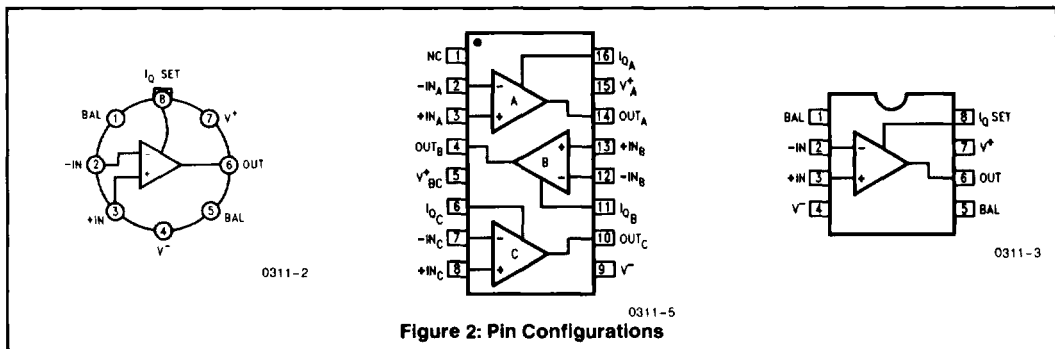
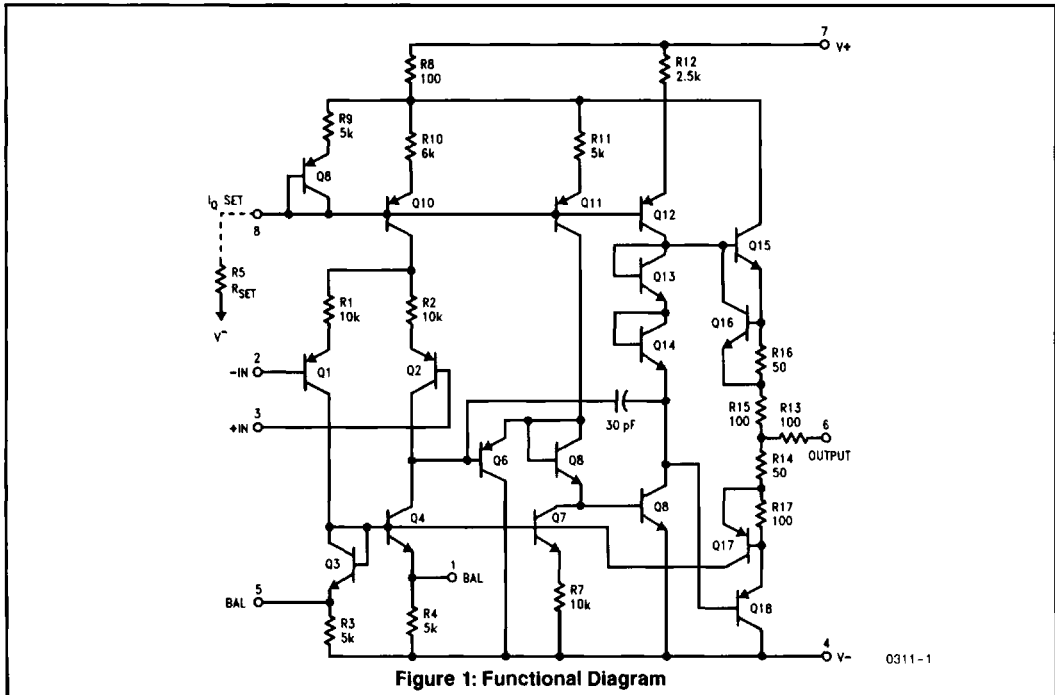

NOTE: All typical values have been characterized but are not tested.

3
OPERATIONAL
AMPLIFIERS

ICL8021/ICL8023

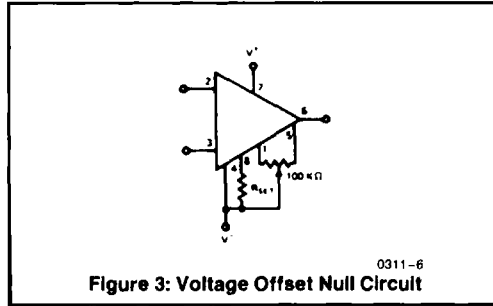

ELECTRICAL CHARACTERISTICS ($V_{SUPPLY} = \pm 6V$, $I_Q = 30\mu A$, unless otherwise specified.)

Characteristics	Test Conditions	8021M			8021C			Units
		Min	Typ	Max	Min	Typ	Max	
The following specifications apply for $T_A = 25^\circ C$:								
Input Offset Voltage	$R_S \leq 100k\Omega$		2	3		2	6	mV
Input Offset Current			0.5	7.5		0.7	10	nA
Input Bias Current			5	20		7	30	nA
Input Resistance ⁽¹⁾		3	10		3	10		M Ω
Input Voltage Range	$V_{SUPPLY} = \pm 15V$	± 12	± 13		± 12	± 13		V
Common Mode Rejection Ratio	$R_S \leq 10k\Omega$	70	80		70	80		dB
Supply Voltage Rejection Ratio	$R_S \leq 10k\Omega$		30	150		30	150	$\mu V/V$
Output Resistance	Open Loop		2			2		k Ω
Output Voltage Swing	$R_L \geq 20k\Omega$, $V_{SUPPLY} = \pm 15V$	± 12	± 14		± 12	± 14		V
	$R_L \geq 10k\Omega$, $V_{SUPPLY} = \pm 15V$	± 11	± 13		± 11	± 13		V
Output Short-Circuit Current			± 13			± 13		mA
Power Consumption	$V_{OUT} = 0$		360	480		360	600	μW
Slew Rate (Unity Gain)			0.16			0.16		V/ μs
Unity Gain Bandwidth	$R_L = 20k\Omega$, $V_{IN} = 20mV$		270			270		kHz
Transient Response (Unity Gain)	$R_L = 20k\Omega$, $V_{IN} = 20mV$	Risetime	1.3			1.3		μs
		Overshoot	10			10		%
Specifications Applicable over Temperature		$-55^\circ C \leq T_A \leq +125^\circ C$			$0^\circ C \leq T_A \leq +70^\circ C$			
Input Offset Voltage	$R_S \leq 10k\Omega$		2.0	5.0		2.0	7.5	mV
Input Offset Current			1.0	11		1.5	15	nA
Input Bias Current			10	32		15	50	nA
Average Temperature Coefficient of Input Offset Voltage	$R_S \leq 10k\Omega$		5			5		$\mu V/^\circ C$
Average Temperature Coefficient of Input Offset Current			1.7			0.8		$pA/^\circ C$
Large Signal Voltage Gain	$R_L = 10k\Omega$	50	200		50	200		V/mV
Output Voltage Swing	$R_L \geq 10k\Omega$	± 10	± 13		± 10	± 13		V

NOTE 1: Not tested; guaranteed by design and process.

NOTE: All typical values have been characterized but are not tested.

ICL8021/ICL8023

QUIESCENT CURRENT ADJUSTMENT

QUIESCENT CURRENT SETTING RESISTOR
(PIN 8 to V⁻)

V _S	I _Q			
	10 μA	30 μA	100 μA	300 μA
± 1.5	1.5MΩ	470kΩ	150kΩ	—
± 3	3.3MΩ	1.1MΩ	330kΩ	100kΩ
± 6	7.5MΩ	2.7MΩ	750kΩ	220kΩ
± 9	13MΩ	4MΩ	1.3MΩ	350kΩ
± 12	18MΩ	5.6MΩ	1.5MΩ	510kΩ
± 15	22MΩ	7.5MΩ	2.2MΩ	620kΩ

QUIESCENT CURRENT SETTING RESISTOR
(PIN 8 to V⁻)

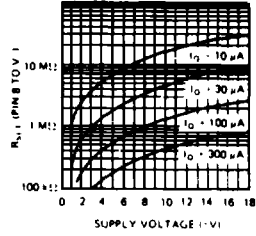

0311-7

TYPICAL PERFORMANCE CHARACTERISTICS*

(T_A = +25°C, V_S = ±6V, I_Q = 30 μA unless otherwise specified.)

INPUT BIAS CURRENT VS QUIESCENT CURRENT

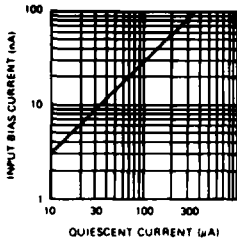

0311-8

INPUT BIAS CURRENT VS AMBIENT TEMPERATURE

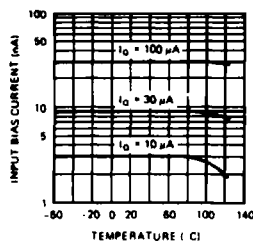

0311-9

DIFFERENTIAL INPUT IMPEDANCE VS QUIESCENT CURRENT

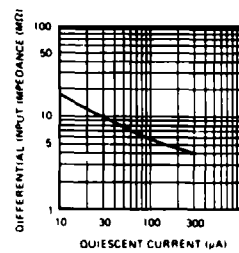

0311-10

$$I_{SET} = \frac{V^+ + |V^-| - 0.6V}{R_{SET} + 5k\Omega}$$

$$I_Q = \frac{I_{SET} + 3 \times 10^{-7}}{0.165}$$

NOTE: All typical values have been characterized but are not tested.

TYPICAL PERFORMANCE CHARACTERISTICS*

($T_A = +25^\circ\text{C}$, $V_S = \pm 6\text{V}$, $I_Q = 30\mu\text{A}$ unless otherwise specified.) (Continued)

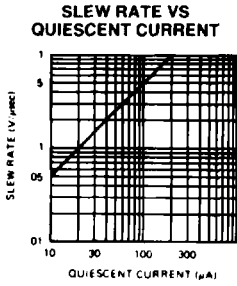

0311-11

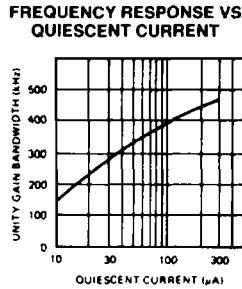

0311-12

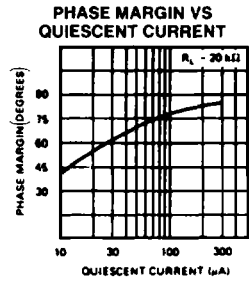

0311-13

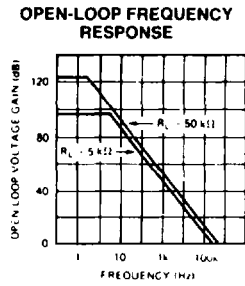

0311-14

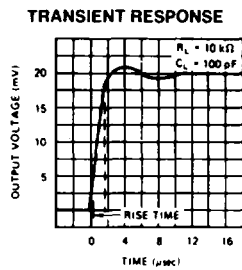

0311-15

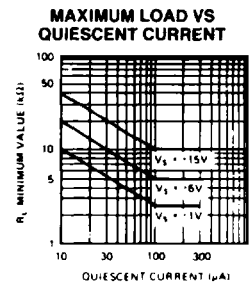

0311-16

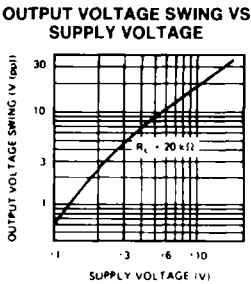

0311-17

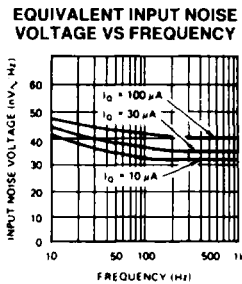

0311-18

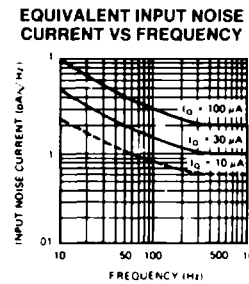

0311-19

*ICL8021C guaranteed only for $0^\circ\text{C} < T_A < +70^\circ\text{C}$

NOTE: All typical values have been characterized but are not tested