

TLV906x 10-MHz, RRIO, CMOS Operational Amplifiers for Cost-Sensitive Systems

1 Features

- Rail-to-Rail Input and Output
- Low Input Offset Voltage: ± 0.3 mV
- Unity-Gain Bandwidth: 10 MHz
- Low Broadband Noise: $10 \text{ nV}/\sqrt{\text{Hz}}$
- Low Input Bias Current: 0.5 pA
- Low Quiescent Current: 538 μA
- Unity-Gain Stable
- Internal RFI and EMI Filter
- Operational at Supply Voltages as Low as 1.8 V
- Easier to Stabilize with Higher Capacitive Load Due to Resistive Open-Loop Output Impedance
- Extended Temperature Range: -40°C to $+125^\circ\text{C}$

2 Applications

- E-Bikes
- Smoke Detectors
- HVAC: Heating, Ventilating, and Air Conditioning
- Motor Control: AC Induction
- Refrigerators
- Wearable Devices
- Laptop Computers
- Washing Machines
- Sensor Signal Conditioning
- Power Modules
- Barcode Scanners
- Active Filters
- Low-Side Current Sensing

3 Description

The TLV9061 (single), TLV9062 (dual), and TLV9064 (quad) are single-, dual-, and quad- low-voltage (1.8 V to 5.5 V) operational amplifiers (op amps) with rail-to-rail input- and output-swing capabilities. These devices are highly cost-effective solutions for applications where low-voltage operation, a small footprint, and high capacitive load drive are required. Although the capacitive load drive of the TLV906x is 100 pF, the resistive open-loop output impedance makes stabilizing with higher capacitive loads simpler. These op amps are designed specifically for low-voltage operation (1.8 V to 5.5 V) with performance specifications similar to the OPAx316 and TLVx316 devices.

The TLV906x family helps simplify system design, because the family is unity-gain stable, integrates the RFI and EMI rejection filter and provides no phase reversal in overdrive condition.

Micro-size packages, such as SOT-553 and WSON, are offered for all the channel variants (single, dual and quad), along with industry-standard packages, such as SOIC, MSOP, SOT-23 and TSSOP.

Device Information⁽¹⁾

| PART NUMBER | PACKAGE | BODY SIZE (NOM) |
|-------------|------------|-------------------|
| TLV9061 | SOT-23 (5) | 1.60 mm x 2.90 mm |
| | SC70 (5) | 1.25 mm x 2.00 mm |
| | SOT553 (5) | 1.65 mm x 1.20 mm |
| | X2SON (5) | 0.80 mm x 0.80 mm |
| | SOIC (8) | 3.91 mm x 4.90 mm |
| TLV9062 | SOIC (8) | 3.91 mm x 4.90 mm |
| | TSSOP (8) | 3.00 mm x 4.40 mm |
| | VSSOP (8) | 3.00 mm x 3.00 mm |
| | VSSOP (10) | 3.00 mm x 3.00 mm |
| | WSON (8) | 2.00 mm x 2.00 mm |
| TLV9064 | SOIC (14) | 8.65 mm x 3.91 mm |
| | TSSOP (14) | 4.40 mm x 5.00 mm |
| | WQFN (16) | 3.00 mm x 3.00 mm |

(1) For all available packages, see the orderable addendum at the end of the data sheet.

Single-Pole, Low-Pass Filter

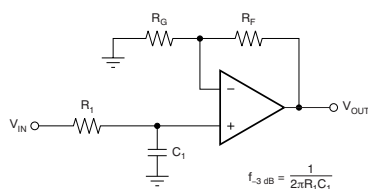

$$\frac{V_{\text{OUT}}}{V_{\text{IN}}} = \left(1 + \frac{R_F}{R_G}\right) \left(\frac{1}{1 + sR_1 C_1}\right)$$

Small-Signal Overshoot vs Load Capacitance

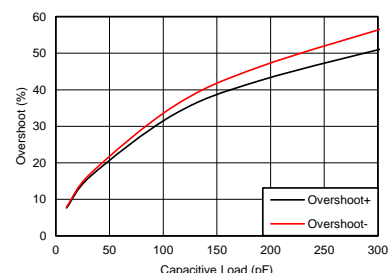

Table of Contents

| | | | |
|--|-----------|--|-----------|
| 1 Features | 1 | 8.4 Device Functional Modes..... | 18 |
| 2 Applications | 1 | 9 Application and Implementation | 19 |
| 3 Description | 1 | 9.1 Application Information..... | 19 |
| 4 Revision History | 2 | 9.2 Typical Application | 19 |
| 5 Device Comparison Table | 3 | 10 Power Supply Recommendations | 21 |
| 6 Pin Configuration and Functions | 4 | 10.1 Input and ESD Protection | 21 |
| 7 Specifications | 7 | 11 Layout | 22 |
| 7.1 Absolute Maximum Ratings | 7 | 11.1 Layout Guidelines | 22 |
| 7.2 ESD Ratings..... | 7 | 11.2 Layout Example | 23 |
| 7.3 Recommended Operating Conditions..... | 7 | 12 Device and Documentation Support | 24 |
| 7.4 Thermal Information: TLV9061 | 7 | 12.1 Documentation Support | 24 |
| 7.5 Thermal Information | 8 | 12.2 Related Links | 24 |
| 7.6 Thermal Information: TLV9064 | 8 | 12.3 Receiving Notification of Documentation Updates | 24 |
| 7.7 Electrical Characteristics: V_S (Total Supply Voltage) = (V_+) – (V_-) = 1.8 V to 5.5 V | 9 | 12.4 Community Resources..... | 24 |
| 7.8 Typical Characteristics | 11 | 12.5 Trademarks | 24 |
| 8 Detailed Description | 17 | 12.6 Electrostatic Discharge Caution..... | 24 |
| 8.1 Overview | 17 | 12.7 Glossary | 25 |
| 8.2 Functional Block Diagram | 17 | 13 Mechanical, Packaging, and Orderable Information | 25 |
| 8.3 Feature Description..... | 18 | 13.1 Package Option Addendum | 26 |

4 Revision History

NOTE: Page numbers for previous revisions may differ from page numbers in the current version.

| Changes from Revision A (June 2017) to Revision B | Page |
|---|-------------|
| • Added 8-pin PW package to <i>Pin Configuration and Functions</i> section | 5 |
| • Added DSG (WSON) package to <i>Thermal Information</i> table | 8 |
| • Added PW (TSSOP) to TLV9062 <i>Thermal Information</i> table | 8 |
| • Changed maximum input offset voltage value from ± 1.6 mV to 2 mV | 9 |
| • Changed maximum input offset voltage value from ± 1.5 to ± 1.6 mV..... | 9 |
| • Changed minimum common-mode rejection ratio input voltage range from 86 dB to 80 dB | 9 |
| • Changed typical input current noise density value from 10 to $23 \text{ fA}/\sqrt{\text{Hz}}$ | 9 |
| • Changed THD + N test conditions from $V_S = 5 \text{ V}$ to $V_S = 5.5 \text{ V}$ | 9 |
| • Added $V_{CM} = 2.5 \text{ V}$ test condition to THD + N parameter in <i>Electrical Characteristics</i> table | 9 |
| • Added maximum output voltage swing value from 25 mV to 60 mV..... | 9 |
| • Changed maximum output voltage swing value from 15 mV to 20 mV | 9 |

| Changes from Original (March 2017) to Revision A | Page |
|--|-------------|
| • Changed device status from Advance Information to Production Data..... | 1 |

5 Device Comparison Table

| DEVICE | NO. OF CHANNELS | PACKAGE LEADS | | | | | | | | RTE |
|---------|-----------------|---------------|-----|-----|-----|----|-----|-----|----|-----|
| | | DBV | DCK | DRL | DPW | D | DSG | DGK | PW | |
| TLV9061 | 1 | 5 | 5 | 5 | 5 | 8 | — | — | — | — |
| TLV9062 | 2 | — | — | — | — | 8 | 8 | 8 | 8 | — |
| TLV9064 | 4 | — | — | — | — | 14 | — | — | 14 | 16 |

6 Pin Configuration and Functions

**TLV9061 DBV and DRL Package
5-Pin SOT-23 and SOT-553
Top View**

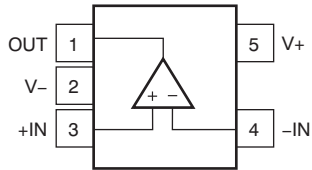

**TLV9061 DCK Package
5-Pin SC70
Top View**

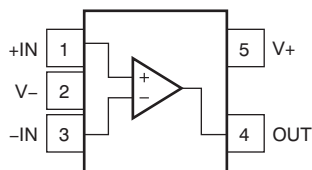

**TLV9061 DPW Package
5-Pin X2SON
Top View**

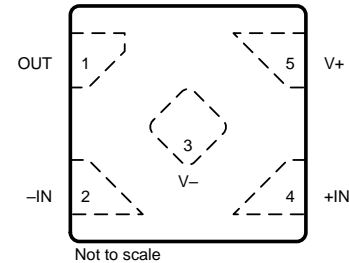

**TLV9061 D Package
8-Pin SOIC
Top View**

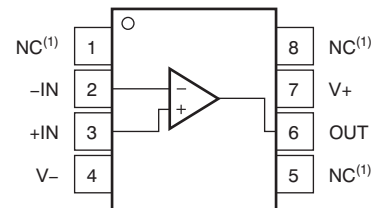

NC - No internal connection

Pin Functions: TLV9061

| NAME | PIN | | | | I/O | DESCRIPTION |
|------|----------|-----|---------|-----|-----|--|
| | DBV, DRL | DCK | D | DPW | | |
| -IN | 4 | 3 | 2 | 2 | I | Inverting input |
| +IN | 3 | 1 | 3 | 4 | I | Noninverting input |
| OUT | 1 | 4 | 6 | 1 | O | Output |
| NC | — | — | 1, 5, 8 | — | — | No internal connection |
| V- | 2 | 2 | 4 | 3 | — | Negative (lowest) supply or ground (for single-supply operation) |
| V+ | 5 | 5 | 7 | 5 | — | Positive (highest) supply |

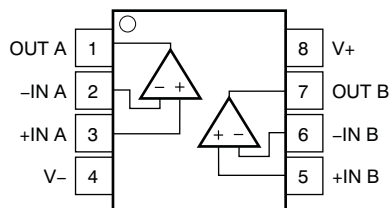
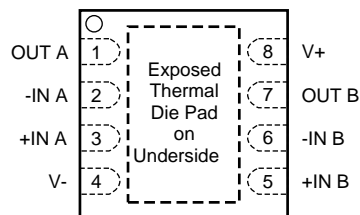
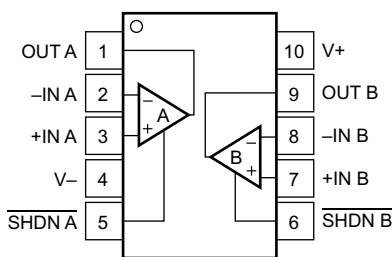
**TLV9062 D, DGK, PW Packages
8-Pin SOIC, VSSOP, TSSOP
Top View**

**TLV9062 DSG Package
8-Pin WSON With Exposed Thermal Pad
Top View**

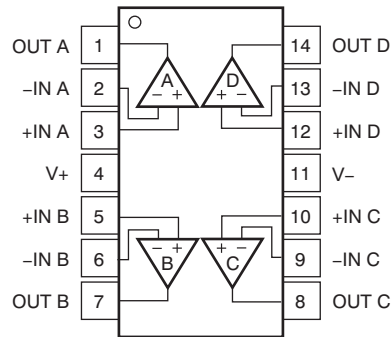
**TLV9062 DGS Package
10-Pin VSSOP
Top View**

Pin Functions: TLV9062

| NAME | PIN | | I/O | DESCRIPTION |
|--------|-----------------|-----|-----|--|
| | D, DGK, DSG, PW | DGS | | |
| -IN A | 2 | 2 | I | Inverting input, channel A |
| +IN A | 3 | 3 | I | Noninverting input, channel A |
| -IN B | 6 | 8 | I | Inverting input, channel B |
| +IN B | 5 | 7 | I | Noninverting input, channel B |
| OUT A | 1 | 1 | O | Output, channel A |
| OUT B | 7 | 9 | O | Output, channel B |
| SHDN A | — | 5 | — | Shutdown (logic low), enable (logic high), channel A |
| SHDN B | — | 6 | — | Shutdown (logic low), enable (logic high), channel B |
| V- | 4 | 4 | — | Negative (lowest) supply or ground (for single-supply operation) |
| V+ | 8 | 10 | — | Positive (highest) supply |

**TLV9064 D, PW Packages
14-Pin SOIC, TSSOP
Top View**

Pin Functions: TLV9064

| PIN | | I/O | DESCRIPTION |
|-------|-----|-----|--|
| NAME | NO. | | |
| -IN A | 2 | I | Inverting input, channel A |
| +IN A | 3 | I | Noninverting input, channel A |
| -IN B | 6 | I | Inverting input, channel B |
| +IN B | 5 | I | Noninverting input, channel B |
| -IN C | 9 | I | Inverting input, channel C |
| +IN C | 10 | I | Noninverting input, channel C |
| -IN D | 13 | I | Inverting input, channel D |
| +IN D | 12 | I | Noninverting input, channel D |
| OUT A | 1 | O | Output, channel A |
| OUT B | 7 | O | Output, channel B |
| OUT C | 8 | O | Output, channel C |
| OUT D | 14 | O | Output, channel D |
| V- | 11 | — | Negative (lowest) supply or ground (for single-supply operation) |
| V+ | 4 | — | Positive (highest) supply |

7 Specifications

7.1 Absolute Maximum Ratings

over operating free-air temperature (unless otherwise noted)⁽¹⁾

| | | | MIN | MAX | UNIT |
|-------------------------------------|---------------------------|--------------|-------------------|------------|------|
| Supply voltage | | | | 6 | V |
| Signal input pins | Voltage ⁽²⁾ | Common-mode | (V-) – 0.5 | (V+) + 0.5 | V |
| | | Differential | (V+) – (V-) + 0.2 | | |
| Current ⁽²⁾ | | | –10 | 10 | mA |
| Output short-circuit ⁽³⁾ | | | Continuous | | mA |
| Temperature | Specified, T _A | | –40 | 125 | °C |
| | Junction, T _J | | | 150 | |
| | Storage, T _{stg} | | –65 | 150 | |

- (1) Stresses beyond those listed under Absolute Maximum Ratings may cause permanent damage to the device. These are stress ratings only, and functional operation of the device at these or any other conditions beyond those indicated under Recommended Operating Conditions is not implied. Exposure to absolute-maximum-rated conditions for extended periods may affect device reliability.
- (2) Input pins are diode-clamped to the power-supply rails. Current limit input signals that can swing more than 0.5 V beyond the supply rails to 10 mA or less.
- (3) Short-circuit to ground, one amplifier per package.

7.2 ESD Ratings

over operating free-air temperature range (unless otherwise noted)

| | | | VALUE | UNIT |
|--------------------|-------------------------|--|-------|------|
| V _(ESD) | Electrostatic discharge | Human body model (HBM), per ANSI/ESDA/JEDEC JS-001 ⁽¹⁾ | ±4000 | V |
| | | Charged device model (CDM), per JEDEC specification JESD22-C101 ⁽²⁾ | ±1500 | |

- (1) JEDEC document JEP155 states that 500-V HBM allows safe manufacturing with a standard ESD control process.
- (2) JEDEC document JEP157 states that 250-V CDM allows safe manufacturing with a standard ESD control process.

7.3 Recommended Operating Conditions

over operating free-air temperature range (unless otherwise noted)

| | | | MIN | MAX | UNIT |
|----------------|-----------------------|--|-----|-----|------|
| V _S | Supply voltage | | 1.8 | 5.5 | V |
| | Specified temperature | | –40 | 125 | °C |

7.4 Thermal Information: TLV9061

| THERMAL METRIC ⁽¹⁾ | TLV9061 | | | UNIT | |
|-------------------------------|--|------------|-------------|-------|------|
| | DBV (SOT-23) | DCK (SC70) | DPW (X2SON) | | |
| | 5 PINS | 5 PINS | 5 PINS | | |
| R _{θJA} | Junction-to-ambient thermal resistance | 221.7 | 263.3 | 467 | °C/W |
| R _{θJC(top)} | Junction-to-case(top) thermal resistance | 144.7 | 75.5 | 211.6 | °C/W |
| R _{θJB} | Junction-to-board thermal resistance | 49.7 | 51 | 332.2 | °C/W |
| ψ _{JT} | Junction-to-top characterization parameter | 26.1 | 1 | 29.3 | °C/W |
| ψ _{JB} | Junction-to-board characterization parameter | 49 | 50.3 | 330.6 | °C/W |
| R _{θJC(bot)} | Junction-to-case(bottom) thermal resistance | N/A | N/A | 125 | °C/W |

- (1) For more information about traditional and new thermal metrics, see the [Semiconductor and IC Package Thermal Metrics](#) application report.

7.5 Thermal Information

| THERMAL METRIC ⁽¹⁾ | | TLV9062 | | | | UNIT |
|-------------------------------|--|----------|-------------|------------|------------|------|
| | | D (SOIC) | DGK (VSSOP) | DSG (WSON) | PW (TSSOP) | |
| | | 8 PINS | 8 PINS | 8 PINS | 8 PINS | |
| $R_{\theta JA}$ | Junction-to-ambient thermal resistance | 157.6 | 201.2 | 94.4 | 205.8 | °C/W |
| $R_{\theta JC(top)}$ | Junction-to-case(top) thermal resistance | 104.6 | 85.7 | 116.5 | 106.7 | °C/W |
| $R_{\theta JB}$ | Junction-to-board thermal resistance | 99.7 | 122.9 | 61.3 | 133.9 | °C/W |
| Ψ_{JT} | Junction-to-top characterization parameter | 55.6 | 21.2 | 13 | 34.4 | °C/W |
| Ψ_{JB} | Junction-to-board characterization parameter | 99.2 | 121.4 | 61.7 | 132.6 | °C/W |
| $R_{\theta JC(bot)}$ | Junction-to-case(bottom) thermal resistance | N/A | N/A | 34.4 | N/A | °C/W |

(1) For more information about traditional and new thermal metrics, see the [Semiconductor and IC Package Thermal Metrics](#) application report.

7.6 Thermal Information: TLV9064

| THERMAL METRIC ⁽¹⁾ | | TLV9064 | | UNIT |
|-------------------------------|--|------------|----------|------|
| | | PW (TSSOP) | D (SOIC) | |
| | | 14 PINS | 14 PINS | |
| $R_{\theta JA}$ | Junction-to-ambient thermal resistance | 135.8 | 106.9 | °C/W |
| $R_{\theta JC(top)}$ | Junction-to-case(top) thermal resistance | 64 | 64 | °C/W |
| $R_{\theta JB}$ | Junction-to-board thermal resistance | 79 | 63 | °C/W |
| Ψ_{JT} | Junction-to-top characterization parameter | 15.7 | 25.9 | °C/W |
| Ψ_{JB} | Junction-to-board characterization parameter | 78.4 | 62.7 | °C/W |

(1) For more information about traditional and new thermal metrics, see the [Semiconductor and IC Package Thermal Metrics](#) application report.

7.7 Electrical Characteristics: V_S (Total Supply Voltage) = (V+) – (V–) = 1.8 V to 5.5 V

 at $T_A = 25^\circ\text{C}$, $R_L = 10\text{ k}\Omega$ connected to $V_S / 2$, $V_{CM} = V_S / 2$, and $V_{OUT} = V_S / 2$ (unless otherwise noted)

| PARAMETER | | TEST CONDITIONS | MIN | TYP | MAX | UNIT |
|----------------------------|--|---|--------------|------------|----------------------|------------------------------|
| OFFSET VOLTAGE | | | | | | |
| V_{OS} | Input offset voltage | $V_S = 5\text{ V}$ $V_S = 5\text{ V}$, $T_A = -40^\circ\text{C}$ to 125°C | | ± 0.3 | ± 1.6 ± 2 | mV |
| dV_{OS}/dT | Drift | $V_S = 5\text{ V}$, $T_A = -40^\circ\text{C}$ to 125°C | | ± 0.53 | | $\mu\text{V}/^\circ\text{C}$ |
| PSRR | Power-supply rejection ratio | $V_S = 1.8\text{ V} - 5.5\text{ V}$, $V_{CM} = (V-)$ | | ± 7 | ± 80 | $\mu\text{V}/\text{V}$ |
| | Channel separation, DC | At DC | | 100 | | dB |
| INPUT VOLTAGE RANGE | | | | | | |
| V_{CM} | Common-mode voltage range | $V_S = 1.8\text{ V}$ to 5.5 V | $(V-) - 0.1$ | | $(V+) + 0.1$ | V |
| CMRR | Common-mode rejection ratio | $V_S = 5.5\text{ V}$, $(V-) - 0.1\text{ V} < V_{CM} < (V+) - 1.4\text{ V}$ $T_A = -40^\circ\text{C}$ to 125°C | 80 | 103 | | dB |
| | | $V_S = 5.5\text{ V}$, $V_{CM} = -0.1\text{ V}$ to 5.6 V $T_A = -40^\circ\text{C}$ to 125°C | 57 | 87 | | |
| | | $V_S = 1.8\text{ V}$, $(V-) - 0.1\text{ V} < V_{CM} < (V+) - 1.4\text{ V}$, $T_A = -40^\circ\text{C}$ to 125°C | | 88 | | |
| | | $V_S = 1.8\text{ V}$, $V_{CM} = -0.1\text{ V}$ to 1.9 V $T_A = -40^\circ\text{C}$ to 125°C | | 81 | | |
| INPUT BIAS CURRENT | | | | | | |
| I_B | Input bias current | | | ± 0.5 | | pA |
| I_{OS} | Input offset current | | | ± 0.05 | | pA |
| NOISE | | | | | | |
| E_n | Input voltage noise (peak-to-peak) | $V_S = 5\text{ V}$, $f = 0.1\text{ Hz}$ to 10 Hz | | 4.77 | | μV_{PP} |
| e_n | Input voltage noise density | $V_S = 5\text{ V}$, $f = 10\text{ kHz}$ | | 10 | | $\text{nV}/\sqrt{\text{Hz}}$ |
| | | $V_S = 5\text{ V}$, $f = 1\text{ kHz}$ | | 16 | | $\text{nV}/\sqrt{\text{Hz}}$ |
| i_n | Input current noise density | $f = 1\text{ kHz}$ | | 23 | | $\text{fA}/\sqrt{\text{Hz}}$ |
| INPUT CAPACITANCE | | | | | | |
| C_{ID} | Differential | | | 2 | | pF |
| C_{IC} | Common-mode | | | 4 | | pF |
| OPEN-LOOP GAIN | | | | | | |
| A_{OL} | Open-loop voltage gain | $V_S = 1.8\text{ V}$, $(V-) + 0.04\text{ V} < V_O < (V+) - 0.04\text{ V}$, $R_L = 10\text{ k}\Omega$ | | 100 | | dB |
| | | $V_S = 5.5\text{ V}$, $(V-) + 0.05\text{ V} < V_O < (V+) - 0.05\text{ V}$, $R_L = 10\text{ k}\Omega$ | 104 | 130 | | |
| | | $V_S = 1.8\text{ V}$, $(V-) + 0.06\text{ V} < V_O < (V+) - 0.06\text{ V}$, $R_L = 2\text{ k}\Omega$ | | 100 | | |
| | | $V_S = 5.5\text{ V}$, $(V-) + 0.15\text{ V} < V_O < (V+) - 0.15\text{ V}$, $R_L = 2\text{ k}\Omega$ | | 130 | | |
| FREQUENCY RESPONSE | | | | | | |
| GBP | Gain bandwidth product | $V_S = 5\text{ V}$, $G = +1$ | | 10 | | MHz |
| ϕ_m | Phase margin | $V_S = 5\text{ V}$, $G = +1$ | | 55 | | Degrees |
| SR | Slew rate | $V_S = 5\text{ V}$, $G = +1$ | | 6.5 | | V/ μs |
| t_s | Settling time | To 0.1%, $V_S = 5\text{ V}$, 2-V step, $G = +1$, $C_L = 100\text{ pF}$ | | 0.5 | | μs |
| | | To 0.01%, $V_S = 5\text{ V}$, 2-V step, $G = +1$, $C_L = 100\text{ pF}$ | | 1 | | |
| t_{OR} | Overload recovery time | $V_S = 5\text{ V}$, $V_{IN} \times \text{gain} > V_S$ | | 0.2 | | μs |
| THD + N | Total harmonic distortion + noise ⁽¹⁾ | $V_S = 5.5\text{ V}$, $V_{CM} = 2.5\text{ V}$, $V_O = 1\text{ V}_{RMS}$, $G = +1$, $f = 1\text{ kHz}$ | | 0.0008% | | |
| OUTPUT | | | | | | |
| V_O | Voltage output swing from supply rails | $V_S = 5.5\text{ V}$, $R_L = 10\text{ k}\Omega$ | | | 20 | mV |
| | | $V_S = 5.5\text{ V}$, $R_L = 2\text{ k}\Omega$ | | | 60 | |
| I_{SC} | Short-circuit current | $V_S = 5\text{ V}$ | | ± 50 | | mA |
| Z_O | Open-loop output impedance | $V_S = 5\text{ V}$, $f = 10\text{ MHz}$ | | 100 | | Ω |
| POWER SUPPLY | | | | | | |

(1) Third-order filter; bandwidth = 80 kHz at –3 dB.

Electrical Characteristics: V_S (Total Supply Voltage) = (V+) – (V–) = 1.8 V to 5.5 V (continued)

 at $T_A = 25^\circ\text{C}$, $R_L = 10\text{ k}\Omega$ connected to $V_S / 2$, $V_{CM} = V_S / 2$, and $V_{OUT} = V_S / 2$ (unless otherwise noted)

| PARAMETER | | TEST CONDITIONS | MIN | TYP | MAX | UNIT |
|-----------|---------------------------------|--|-----|-----|-----|---------------|
| I_Q | Quiescent current per amplifier | $V_S = 5.5\text{ V}$, $I_O = 0\text{ mA}$ | | 538 | 750 | μA |
| | | $V_S = 5.5\text{ V}$, $I_O = 0\text{ mA}$ $T_A = -40^\circ\text{C}$ to $+125^\circ\text{C}$ | | | 800 | |

7.8 Typical Characteristics

at $T_A = 25^\circ\text{C}$, $V_S = 5.5\text{ V}$, $R_L = 10\text{ k}\Omega$ connected to $V_S / 2$, $V_{CM} = V_S / 2$, and $V_{OUT} = V_S / 2$ (unless otherwise noted)

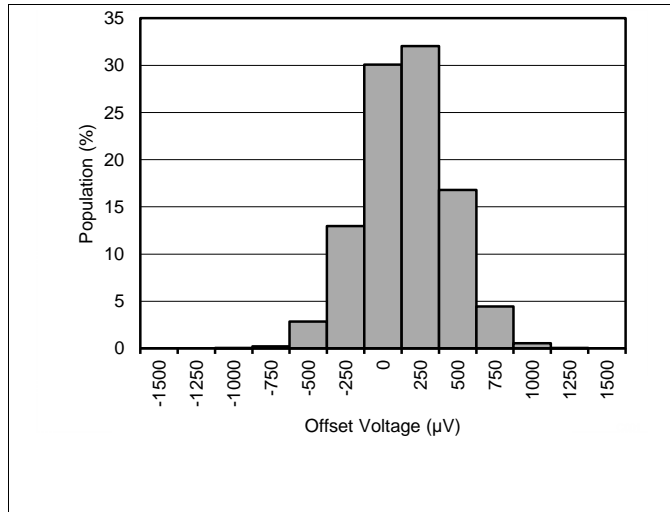
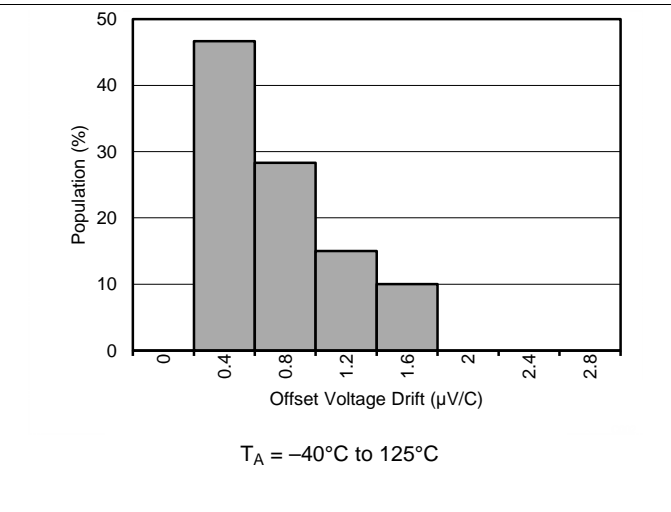

Figure 1. Offset Voltage Production Distribution



$T_A = -40^\circ\text{C}$ to 125°C

Figure 2. Offset Voltage Drift Distribution

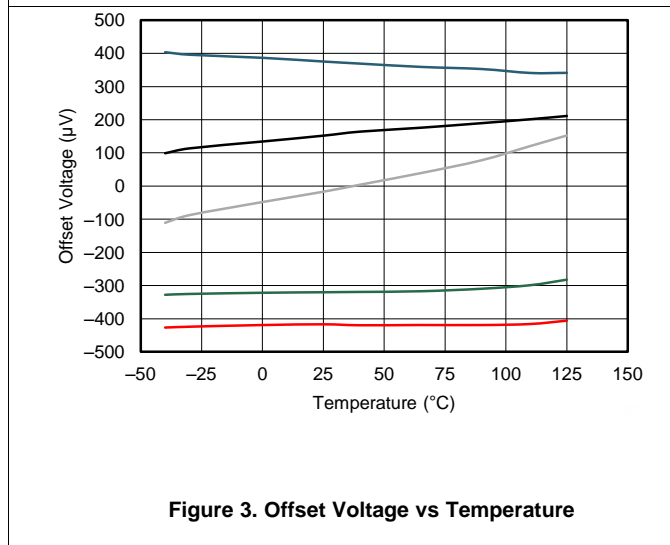
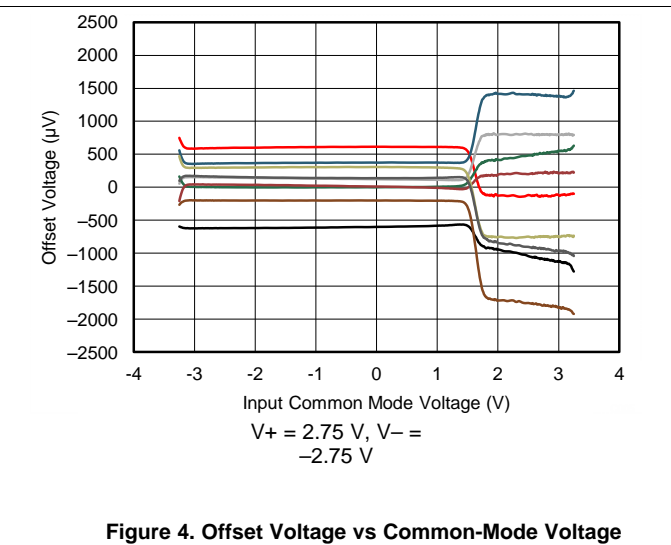
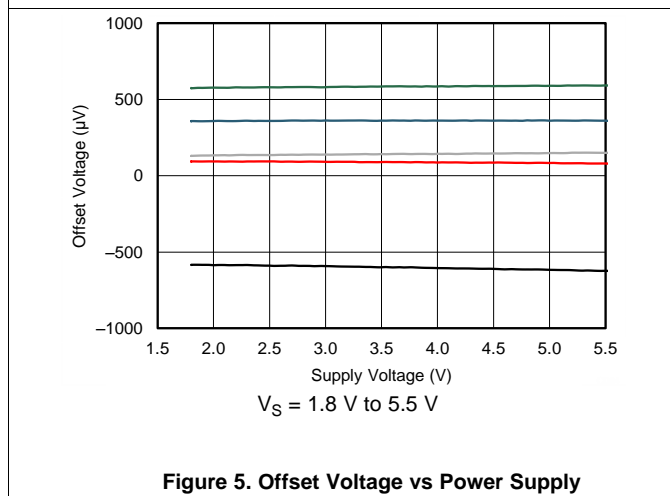

Figure 3. Offset Voltage vs Temperature



$V_+ = 2.75\text{ V}$, $V_- = -2.75\text{ V}$

Figure 4. Offset Voltage vs Common-Mode Voltage



$V_S = 1.8\text{ V}$ to 5.5 V

Figure 5. Offset Voltage vs Power Supply

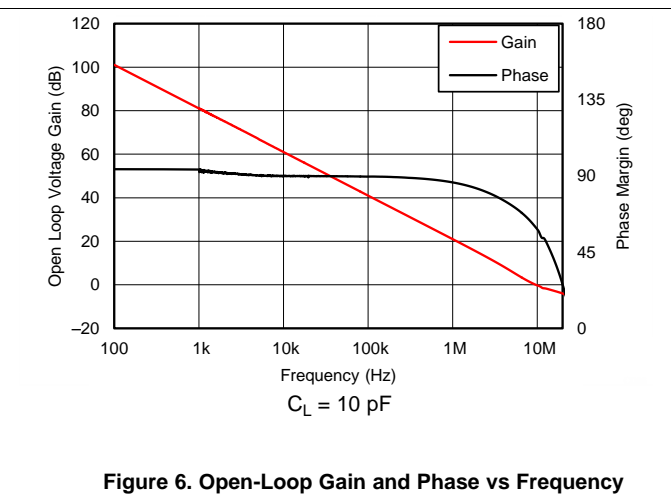

$C_L = 10\text{ pF}$

Figure 6. Open-Loop Gain and Phase vs Frequency

Typical Characteristics (continued)

at $T_A = 25^\circ\text{C}$, $V_S = 5.5\text{ V}$, $R_L = 10\text{ k}\Omega$ connected to $V_S / 2$, $V_{CM} = V_S / 2$, and $V_{OUT} = V_S / 2$ (unless otherwise noted)

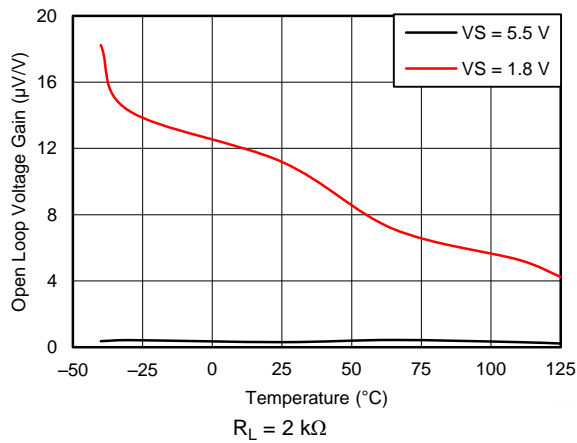

Figure 7. Open-Loop Gain vs Temperature

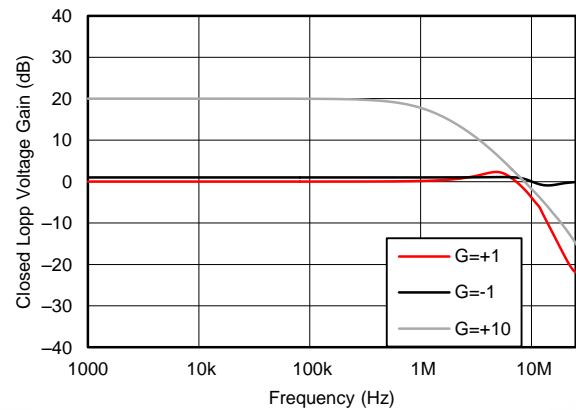

Figure 8. Closed-Loop Gain vs Frequency

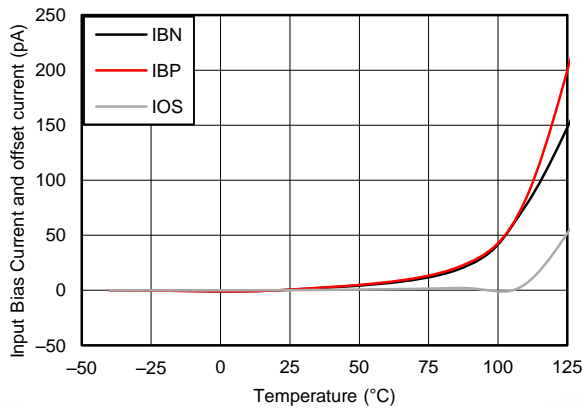

Figure 9. Input Bias Current vs Temperature

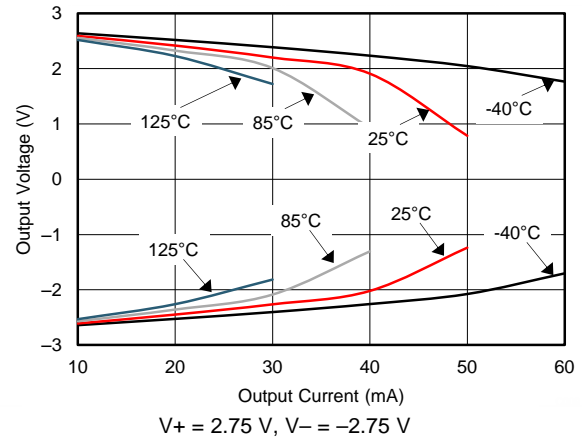

Figure 10. Output Voltage Swing vs Output Current

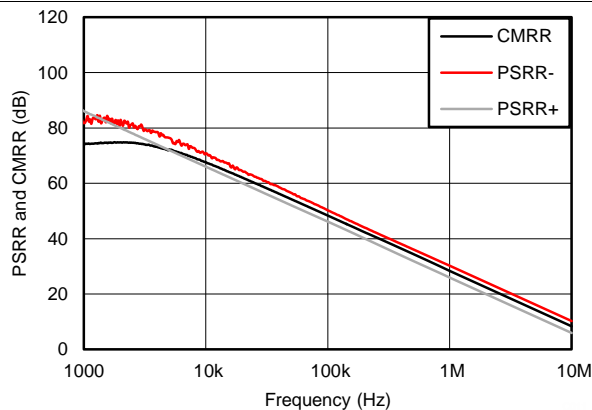

Figure 11. CMRR and PSRR vs Frequency (Referred to Input)

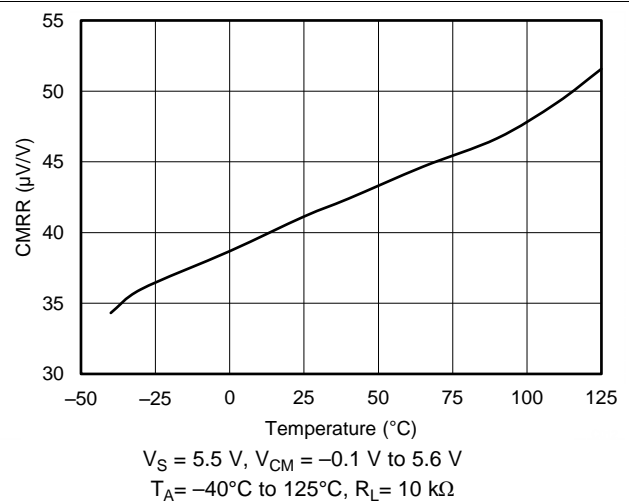
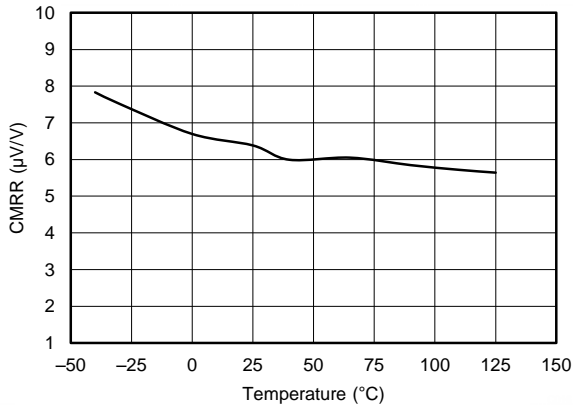

Figure 12. CMRR vs Temperature

Typical Characteristics (continued)

at $T_A = 25^\circ\text{C}$, $V_S = 5.5\text{ V}$, $R_L = 10\text{ k}\Omega$ connected to $V_S / 2$, $V_{CM} = V_S / 2$, and $V_{OUT} = V_S / 2$ (unless otherwise noted)



$V_S = 5.5\text{ V}$, $V_{CM} = (V_-) - 0.1\text{ V to } (V_+) - 1.4\text{ V}$
 $T_A = -40^\circ\text{C to } +125^\circ\text{C}$, $R_L = 10\text{ k}\Omega$

Figure 13. CMRR vs Temperature

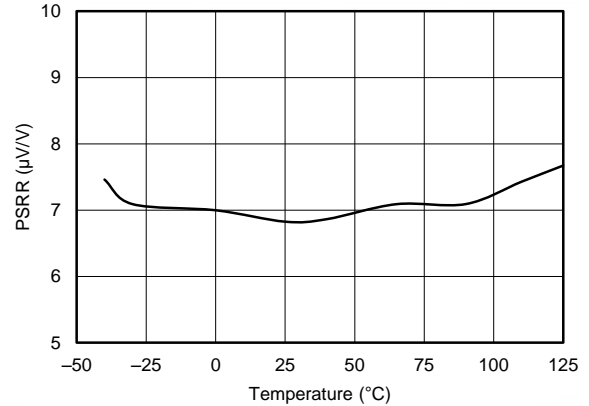

$V_S = 1.8\text{ V to } 5.5\text{ V}$

Figure 14. PSRR vs Temperature

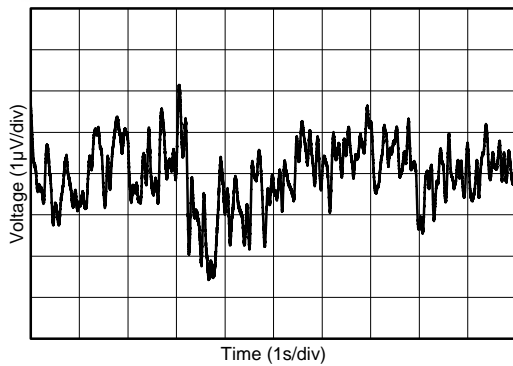

$V_S = 1.8\text{ V to } 5.5\text{ V}$

Figure 15. 0.1-Hz to 10-Hz Input Voltage Noise

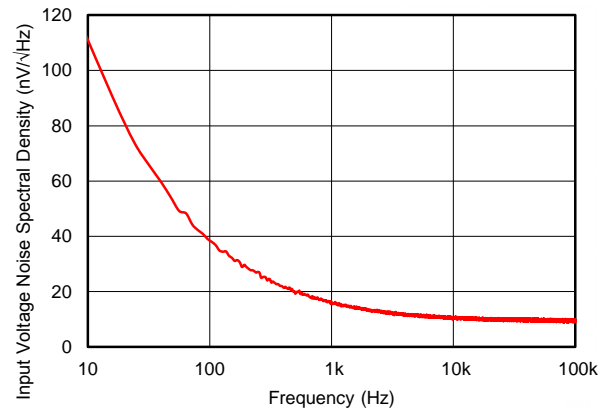
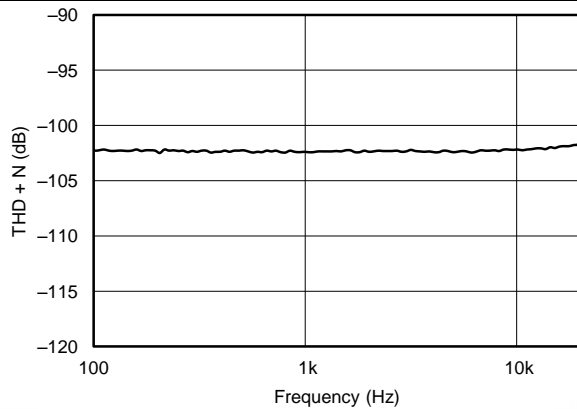
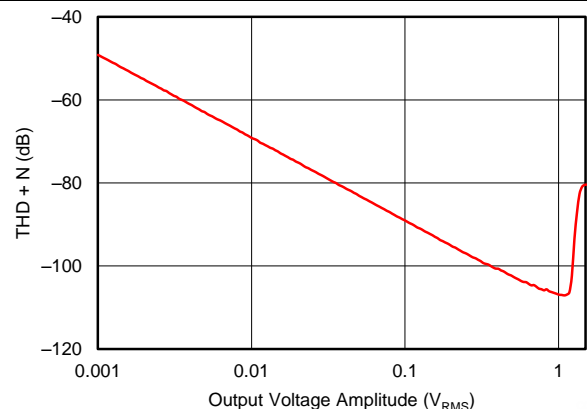

Figure 16. Input Voltage Noise Spectral Density vs Frequency



$V_S = 5.5\text{ V}$, $V_{CM} = 2.5\text{ V}$, $R_L = 2\text{ k}\Omega$, $G = +1$, $BW = 80\text{ kHz}$
 $V_{OUT} = 0.5 V_{RMS}$

Figure 17. THD + N vs Frequency



$V_S = 5.5\text{ V}$, $V_{CM} = 2.5\text{ V}$, $R_L = 2\text{ k}\Omega$, $G = +1$
 $BW = 80\text{ kHz}$, $f = 1\text{ kHz}$

Figure 18. THD + N vs Amplitude

Typical Characteristics (continued)

at $T_A = 25^\circ\text{C}$, $V_S = 5.5\text{ V}$, $R_L = 10\text{ k}\Omega$ connected to $V_S / 2$, $V_{CM} = V_S / 2$, and $V_{OUT} = V_S / 2$ (unless otherwise noted)

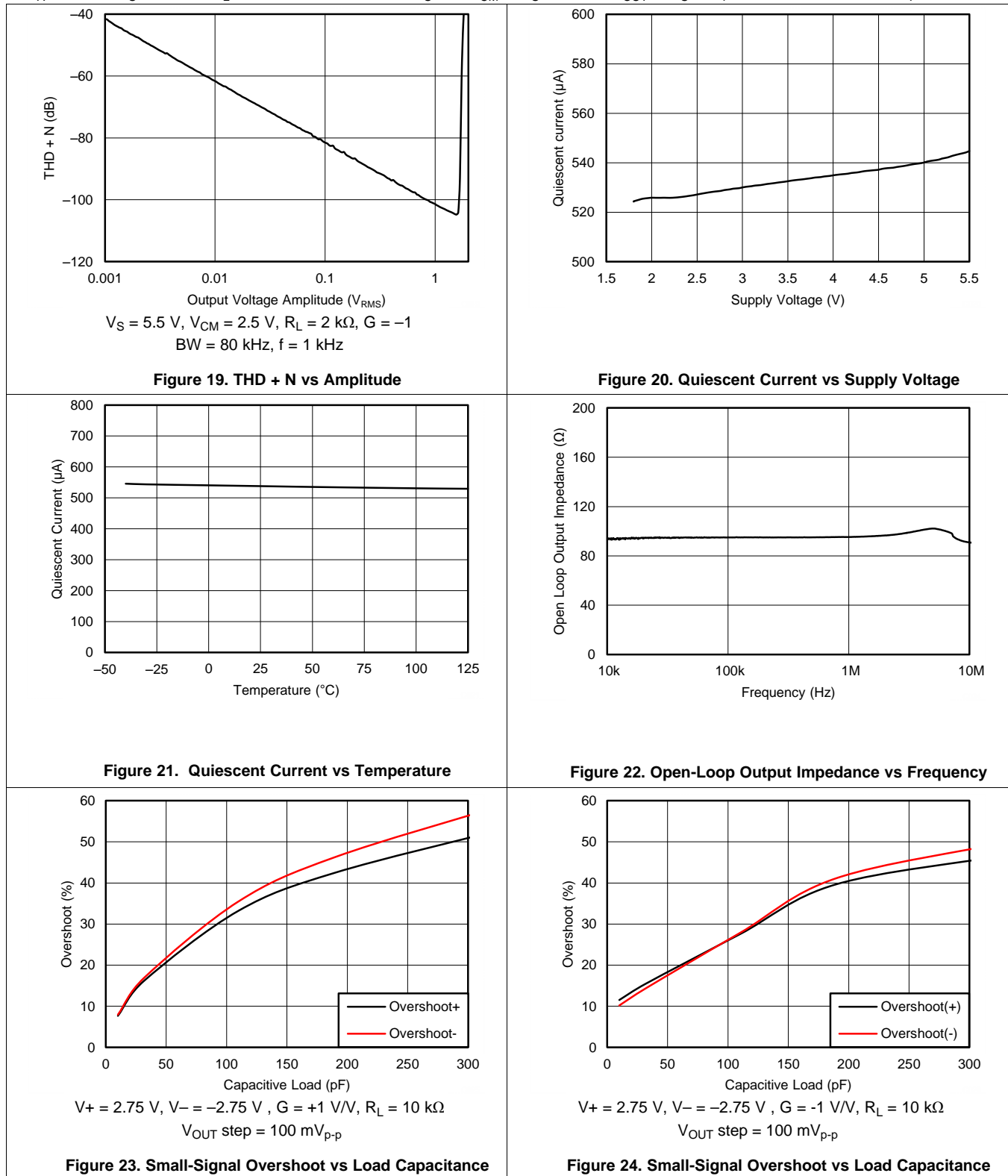

Typical Characteristics (continued)

at $T_A = 25^\circ\text{C}$, $V_S = 5.5\text{ V}$, $R_L = 10\text{ k}\Omega$ connected to $V_S / 2$, $V_{CM} = V_S / 2$, and $V_{OUT} = V_S / 2$ (unless otherwise noted)

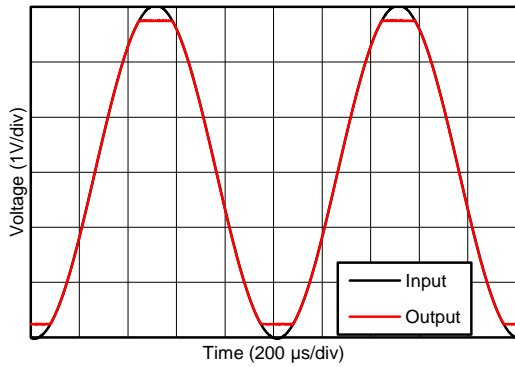

$V_+ = 2.75\text{ V}$, $V_- = -2.75\text{ V}$

Figure 25. No Phase Reversal

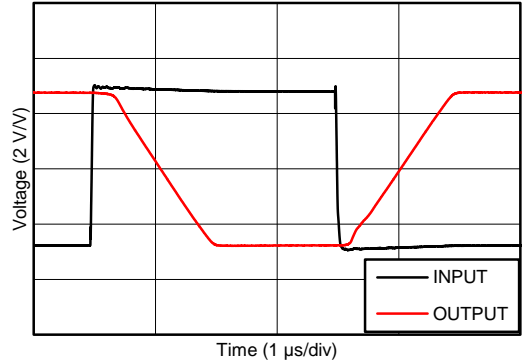

$V_+ = 2.75\text{ V}$, $V_- = -2.75\text{ V}$, $G = -10\text{ V/V}$

Figure 26. Overload Recovery

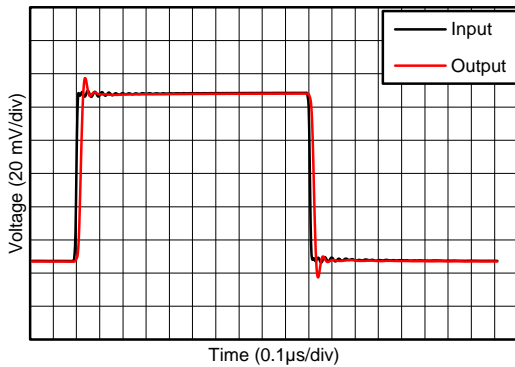

$V_+ = 2.75\text{ V}$, $V_- = -2.75\text{ V}$, $G = 1\text{ V/V}$

Figure 27. Small-Signal Step Response

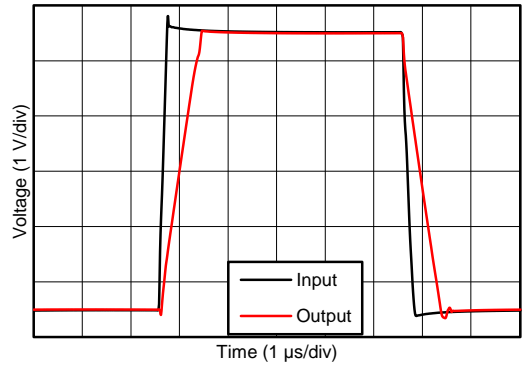

$V_+ = 2.75\text{ V}$, $V_- = -2.75\text{ V}$, $C_L = 100\text{ pF}$, $G = 1\text{ V/V}$

Figure 28. Large-Signal Step Response

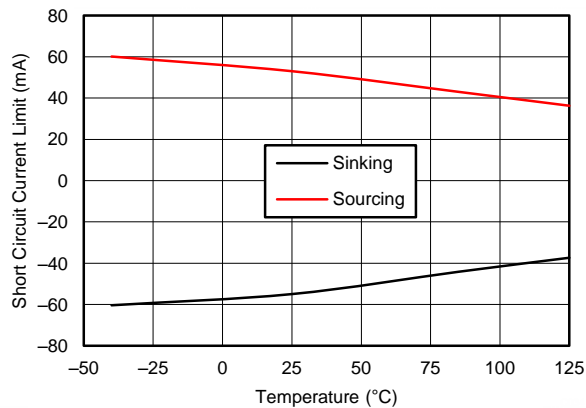

Figure 29. Short-Circuit Current vs Temperature

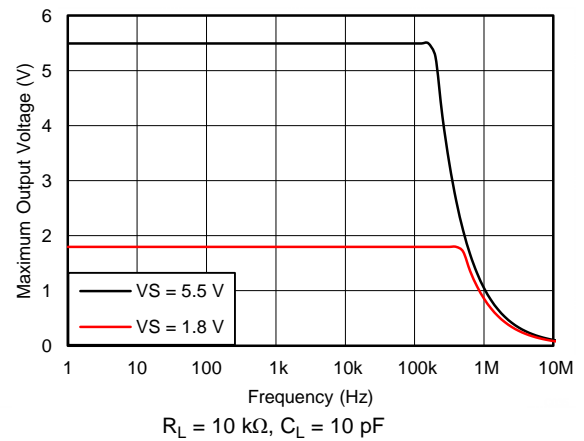

Figure 30. Maximum Output Voltage vs Frequency and Supply Voltage

Typical Characteristics (continued)

at $T_A = 25^\circ\text{C}$, $V_S = 5.5\text{ V}$, $R_L = 10\text{ k}\Omega$ connected to $V_S / 2$, $V_{CM} = V_S / 2$, and $V_{OUT} = V_S / 2$ (unless otherwise noted)

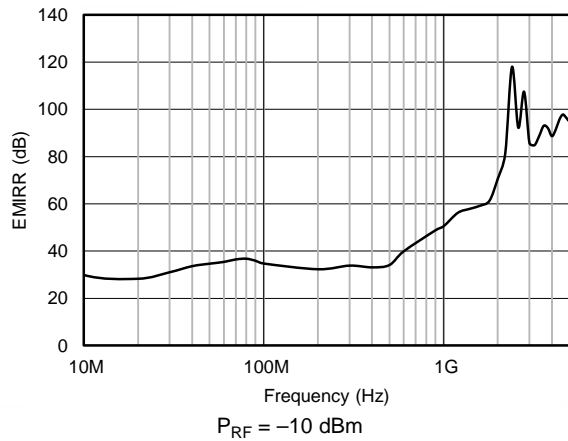

Figure 31. Electromagnetic Interference Rejection Ratio Referred to Noninverting Input (EMIRR+) vs Frequency

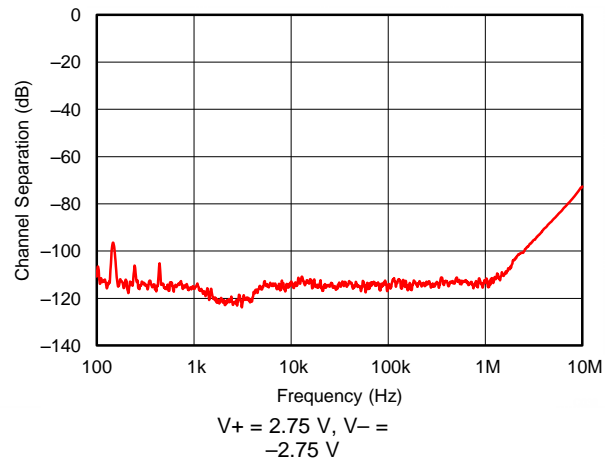

Figure 32. Channel Separation vs Frequency

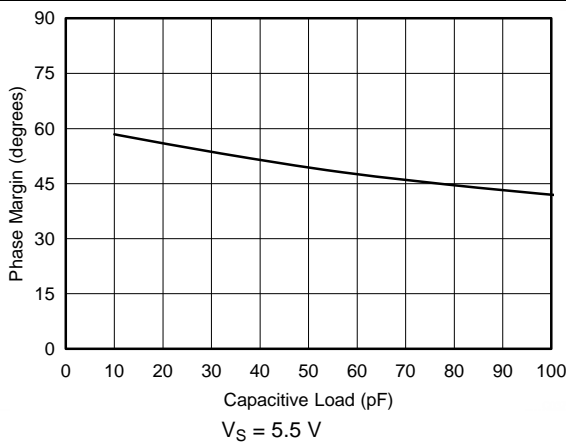

Figure 33. Phase Margin vs Capacitive Load

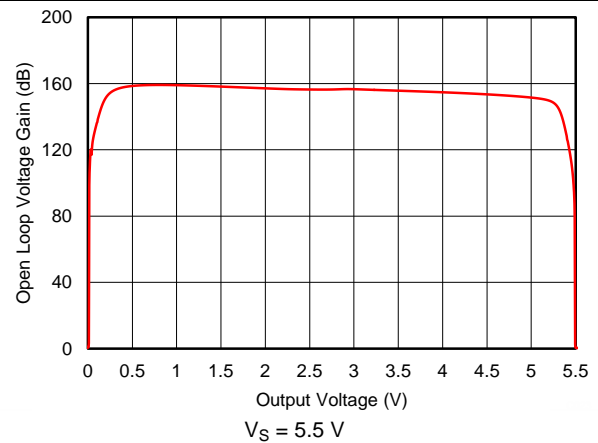

Figure 34. Open Loop Voltage Gain vs Output Voltage

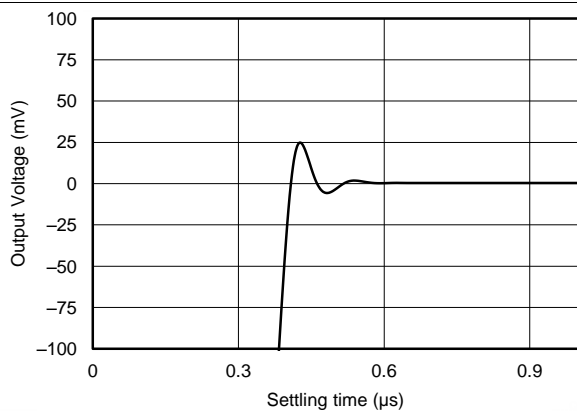

Figure 35. Large Signal Settling Time (Positive)

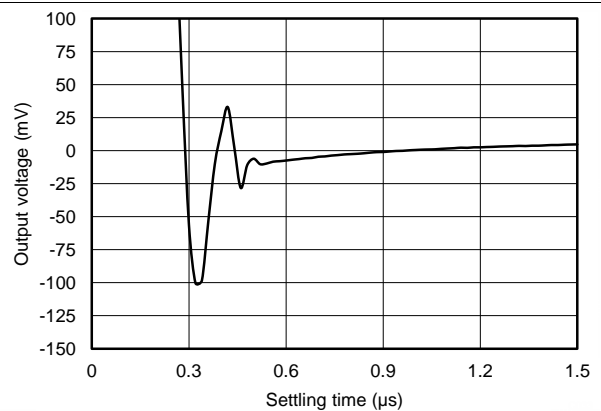

Figure 36. Large Signal Settling Time (Negative)

8 Detailed Description

8.1 Overview

The TLV906x series is a family of low-power, rail-to-rail input and output op amps. These devices operate from 1.8 V to 5.5 V, are unity-gain stable, and are suitable for a wide range of general-purpose applications. The input common-mode voltage range includes both rails and allows the TLV906x series to be used in virtually any single-supply application. Rail-to-rail input and output swing significantly increases dynamic range, especially in low-supply applications, and makes them suitable for driving sampling analog-to-digital converters (ADCs).

8.2 Functional Block Diagram

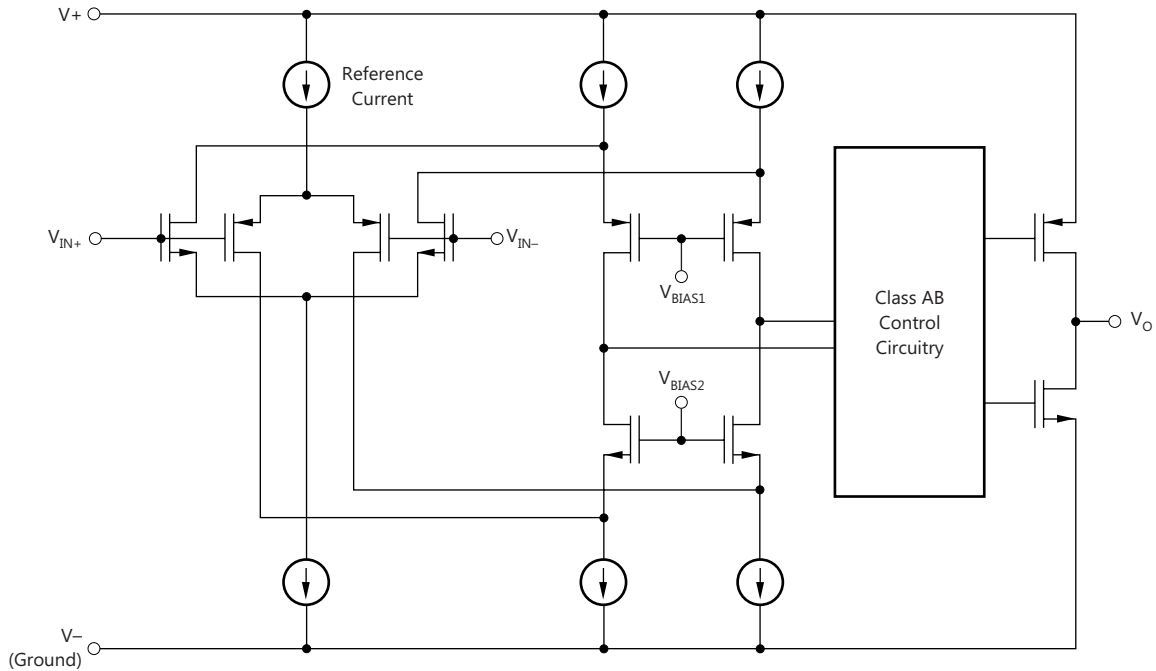

Copyright © 2017, Texas Instruments Incorporated

8.3 Feature Description

8.3.1 Rail-to-Rail Input

The input common-mode voltage range of the TLV906x family extends 100 mV beyond the supply rails for the full supply voltage range of 1.8 V to 5.5 V. This performance is achieved with a complementary input stage: an N-channel input differential pair in parallel with a P-channel differential pair, as shown in the [Functional Block Diagram](#). The N-channel pair is active for input voltages close to the positive rail, typically $(V+) - 1.4$ V to 200 mV above the positive supply, whereas the P-channel pair is active for inputs from 200 mV below the negative supply to approximately $(V+) - 1.4$ V. There is a small transition region, typically $(V+) - 1.2$ V to $(V+) - 1$ V, in which both pairs are on. This 200-mV transition region can vary up to 200 mV with process variation. Thus, the transition region (with both stages on) can range from $(V+) - 1.4$ V to $(V+) - 1.2$ V on the low end, and up to $(V+) - 1$ V to $(V+) - 0.8$ V on the high end. Within this transition region, PSRR, CMRR, offset voltage, offset drift, and THD can degrade compared to device operation outside this region.

8.3.2 Rail-to-Rail Output

Designed as a low-power, low-voltage operational amplifier, the TLV906x series delivers a robust output drive capability. A class AB output stage with common-source transistors achieves full rail-to-rail output swing capability. For resistive loads of 10-k Ω , the output swings to within 15 mV of either supply rail, regardless of the applied power-supply voltage. Different load conditions change the ability of the amplifier to swing close to the rails.

8.3.3 Overload Recovery

Overload recovery is defined as the time required for the operational amplifier output to recover from a saturated state to a linear state. The output devices of the operational amplifier enter a saturation region when the output voltage exceeds the rated operating voltage, because of the high input voltage or the high gain. After the device enters the saturation region, the charge carriers in the output devices require time to return to the linear state. After the charge carriers return to the linear state, the device begins to slew at the specified slew rate. Therefore, the propagation delay (in case of an overload condition) is the sum of the overload recovery time and the slew time. The overload recovery time for the TLV906x series is approximately 200 ns.

8.4 Device Functional Modes

The TLV906x family has a single functional mode. These devices are powered on as long as the power-supply voltage is between 1.8 V (± 0.9 V) and 5.5 V (± 2.75 V).

9 Application and Implementation

NOTE

Information in the following applications sections is not part of the TI component specification, and TI does not warrant its accuracy or completeness. TI's customers are responsible for determining suitability of components for their purposes. Customers should validate and test their design implementation to confirm system functionality.

9.1 Application Information

The TLV906x series features 10-MHz bandwidth and 6.5-V/ μ s slew rate with only 538- μ A of supply current per channel, providing good ac performance at very-low-power consumption. DC applications are well served with a very-low input noise voltage of 10 nV / $\sqrt{\text{Hz}}$ at 10 kHz, low input bias current, and a typical input offset voltage of 0.3 mV.

9.2 Typical Application

Figure 37 shows the TLV906x configured in a low-side current sensing application.

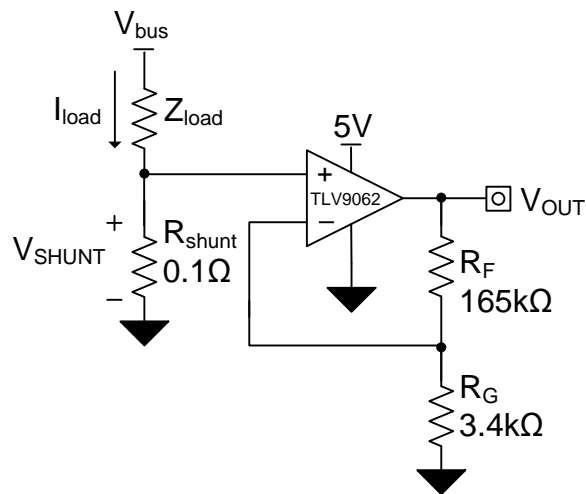

Figure 37. TLV906x in a Low-Side, Current-Sensing Application

9.2.1 Design Requirements

The design requirements for this design are:

- Load current: 0 A to 1 A
- Output voltage: 4.95 V
- Maximum shunt voltage: 100 mV

Typical Application (continued)

9.2.2 Detailed Design Procedure

The transfer function of the circuit in [Figure 37](#) is given in [Equation 1](#)

$$V_{OUT} = I_{LOAD} \times R_{SHUNT} \times \text{Gain} \quad (1)$$

The load current (I_{LOAD}) produces a voltage drop across the shunt resistor (R_{SHUNT}). The load current is set from 0 A to 1 A. To keep the shunt voltage below 100 mV at maximum load current, the largest shunt resistor is defined using [Equation 2](#).

$$R_{SHUNT} = \frac{V_{SHUNT_MAX}}{I_{LOAD_MAX}} = \frac{100\text{mV}}{1\text{A}} = 100\text{m}\Omega \quad (2)$$

Using [Equation 2](#), R_{SHUNT} is calculated to be 100 m Ω . The voltage drop produced by I_{LOAD} and R_{SHUNT} is amplified by the TLV906x to produce an output voltage of roughly 0 V to 4.95 V. The gain needed by the TLV906x to produce the necessary output voltage is calculated using [Equation 3](#):

$$\text{Gain} = \frac{(V_{OUT_MAX} - V_{OUT_MIN})}{(V_{IN_MAX} - V_{IN_MIN})} \quad (3)$$

Using [Equation 3](#), the required gain is calculated to be 49.5 V/V, which is set with resistors R_F and R_G . [Equation 4](#) is used to size the resistors, R_F and R_G , to set the gain of the TLV906x to 49.5 V/V.

$$\text{Gain} = 1 + \frac{(R_F)}{(R_G)} \quad (4)$$

Choosing R_F as 165 k Ω and R_G as 3.4 k Ω provides a combination that equals roughly 49.5 V/V. [Figure 38](#) shows the measured transfer function of the circuit shown in [Figure 37](#).

9.2.3 Application Curve

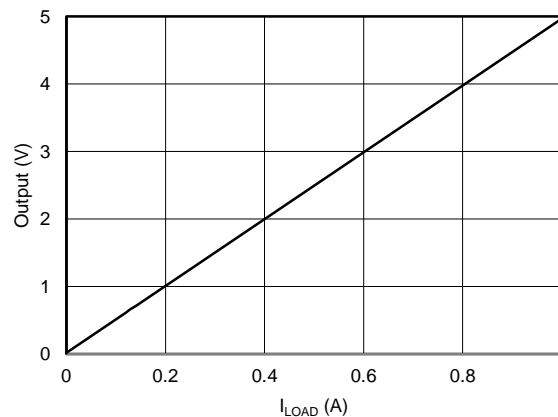

Figure 38. Low-Side, Current-Sense, Transfer Function

10 Power Supply Recommendations

The TLV906x series is specified for operation from 1.8 V to 5.5 V (± 0.9 V to ± 2.75 V); many specifications apply from -40°C to $+125^{\circ}\text{C}$. The [Typical Characteristics](#) section presents parameters that can exhibit significant variance with regard to operating voltage or temperature.

CAUTION

Supply voltages larger than 6 V can permanently damage the device; see the [Absolute Maximum Ratings](#) table.

Place 0.1- μF bypass capacitors close to the power-supply pins to reduce errors coupling in from noisy or high-impedance power supplies. For more detailed information on bypass capacitor placement, see the section.

10.1 Input and ESD Protection

The TLV906x series incorporates internal ESD protection circuits on all pins. For input and output pins, this protection primarily consists of current-steering diodes connected between the input and power-supply pins. These ESD protection diodes provide in-circuit, input overdrive protection, as long as the current is limited to 10-mA, as stated in the [Absolute Maximum Ratings](#) table. [Figure 39](#) shows how a series input resistor can be added to the driven input to limit the input current. The added resistor contributes thermal noise at the amplifier input and the value must be kept to a minimum in noise-sensitive applications.

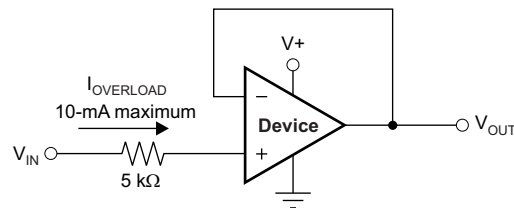

Figure 39. Input Current Protection

11 Layout

11.1 Layout Guidelines

For best operational performance of the device, use good printed circuit board (PCB) layout practices, including:

- Noise can propagate into analog circuitry through the power pins of the circuit as a whole and of op amp itself. Bypass capacitors are used to reduce the coupled noise by providing low-impedance power sources local to the analog circuitry.
 - Connect low-ESR, 0.1- μ F ceramic bypass capacitors between each supply pin and ground, placed as close to the device as possible. A single bypass capacitor from V+ to ground is applicable for single-supply applications.
- Separate grounding for analog and digital portions of circuitry is one of the simplest and most-effective methods of noise suppression. One or more layers on multilayer PCBs are usually devoted to ground planes. A ground plane helps distribute heat and reduces electromagnetic interference (EMI) noise pickup. Make sure to physically separate digital and analog grounds, paying attention to the flow of the ground current. For more detailed information refer to, see [Circuit Board Layout Techniques](#).
- In order to reduce parasitic coupling, run the input traces as far away from the supply or output traces as possible. If these traces cannot be kept separate, crossing the sensitive trace perpendicular is much better as opposed to in parallel with the noisy trace.
- Place the external components as close to the device as possible. As illustrated in [Figure 41](#), keeping RF and RG close to the inverting input minimizes parasitic capacitance on the inverting input.
- Keep the length of input traces as short as possible. Always remember that the input traces are the most sensitive part of the circuit.
- Consider a driven, low-impedance guard ring around the critical traces. A guard ring can significantly reduce leakage currents from nearby traces that are at different potentials.
- Cleaning the PCB following board assembly is recommended for best performance.
- Any precision integrated circuit can experience performance shifts resulting from moisture ingress into the plastic package. Following any aqueous PCB cleaning process, baking the PCB assembly is recommended to remove moisture introduced into the device packaging during the cleaning process. A low-temperature, post-cleaning bake at 85°C for 30 minutes is sufficient for most circumstances.

11.2 Layout Example

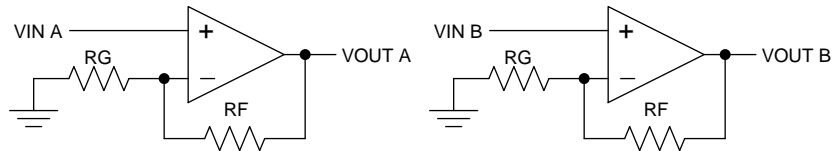

Figure 40. Schematic Representation for Figure 41

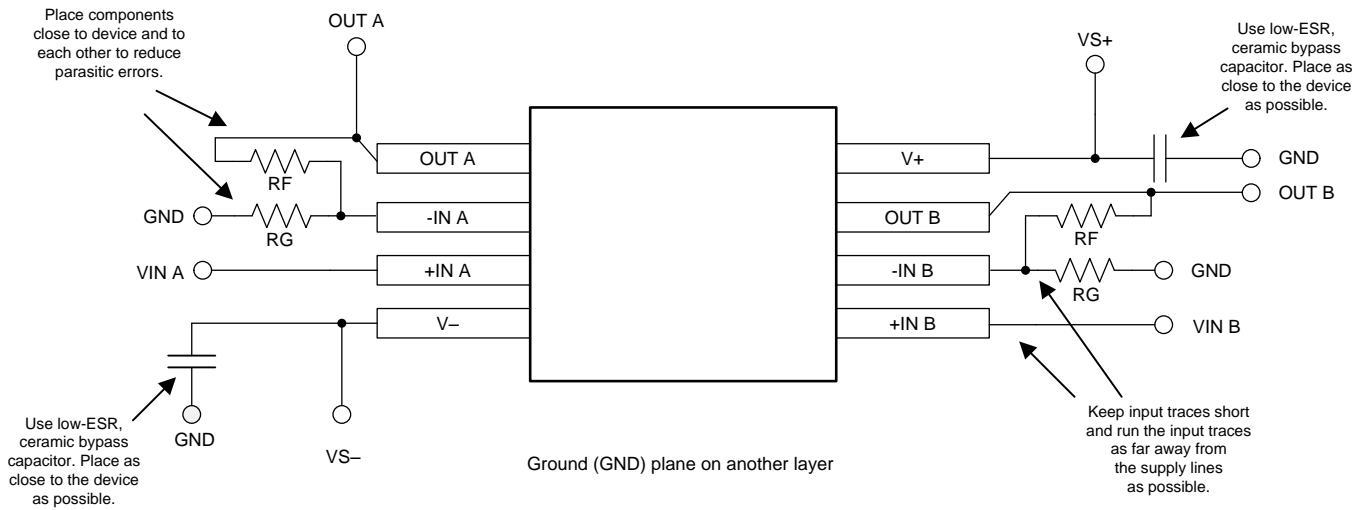

Figure 41. Layout Example

12 Device and Documentation Support

12.1 Documentation Support

12.1.1 Related Documentation

[TLVx313 Low-Power, Rail-to-Rail In/Out, 500- \$\mu\$ V Typical Offset, 1-MHz Operational Amplifier for Cost-Sensitive Systems.](#)

[TLVx314 3-MHz, Low-Power, Internal EMI Filter, RRIO, Operational Amplifier.](#)

[EMI Rejection Ratio of Operational Amplifiers.](#)

[QFN/SON PCB Attachment.](#)

[Quad Flatpack No-Lead Logic Packages.](#)

[Circuit Board Layout Techniques.](#)

[Single-Ended Input to Differential Output Conversion Circuit Reference Design.](#)

12.2 Related Links

The table below lists quick access links. Categories include technical documents, support and community resources, tools and software, and quick access to order now.

Table 1. Related Links

| PARTS | PRODUCT FOLDER | ORDER NOW | TECHNICAL DOCUMENTS | TOOLS & SOFTWARE | SUPPORT & COMMUNITY |
|---------|----------------------------|----------------------------|----------------------------|----------------------------|----------------------------|
| TLV9061 | Click here | Click here | Click here | Click here | Click here |
| TLV9062 | Click here | Click here | Click here | Click here | Click here |
| TLV9064 | Click here | Click here | Click here | Click here | Click here |

12.3 Receiving Notification of Documentation Updates

To receive notification of documentation updates, navigate to the device product folder on ti.com. In the upper right corner, click on *Alert me* to register and receive a weekly digest of any product information that has changed. For change details, review the revision history included in any revised document.

12.4 Community Resources

The following links connect to TI community resources. Linked contents are provided "AS IS" by the respective contributors. They do not constitute TI specifications and do not necessarily reflect TI's views; see TI's [Terms of Use](#).

TI E2E™ Online Community *TI's Engineer-to-Engineer (E2E) Community*. Created to foster collaboration among engineers. At e2e.ti.com, you can ask questions, share knowledge, explore ideas and help solve problems with fellow engineers.

Design Support *TI's Design Support* Quickly find helpful E2E forums along with design support tools and contact information for technical support.

12.5 Trademarks

E2E is a trademark of Texas Instruments.

All other trademarks are the property of their respective owners.

12.6 Electrostatic Discharge Caution



This integrated circuit can be damaged by ESD. Texas Instruments recommends that all integrated circuits be handled with appropriate precautions. Failure to observe proper handling and installation procedures can cause damage.

ESD damage can range from subtle performance degradation to complete device failure. Precision integrated circuits may be more susceptible to damage because very small parametric changes could cause the device not to meet its published specifications.

12.7 Glossary

[SLYZ022](#) — *TI Glossary*.

This glossary lists and explains terms, acronyms, and definitions.

13 Mechanical, Packaging, and Orderable Information

The following pages include mechanical, packaging, and orderable information. This information is the most current data available for the designated devices. This data is subject to change without notice and revision of this document. For browser-based versions of this data sheet, refer to the left-hand navigation.

13.1 Package Option Addendum

13.1.1 Packaging Information

| Orderable Device | Status ⁽¹⁾ | Package Type | Package Drawing | Pins | Package Qty | Eco Plan ⁽²⁾ | Lead/Ball Finish ⁽³⁾ | MSL Peak Temp ⁽⁴⁾ | Op Temp (°C) | Device Marking ⁽⁵⁾⁽⁶⁾ |
|------------------|-----------------------|--------------|-----------------|------|-------------|-------------------------|---------------------------------|------------------------------|--------------|----------------------------------|
| PTLV9062IDSGR | ACTIVE | WSON | DSG | 8 | 3000 | TBD | Call TI | Call TI | -40 to 125 | |
| TLV9062IDR | ACTIVE | SOIC | D | 8 | 2500 | Green (RoHS & no Sb/Br) | CU SN | Level-2-260C-1 YEAR | -40 to 125 | TL9062 |
| TLV9062IDSGR | PREVIEW | WSON | DSG | 8 | 3000 | Green (RoHS & no Sb/Br) | CU NIPDAU | Level-2-260C-1 YEAR | -40 to 125 | T062 |
| TLV9062IDSGT | PREVIEW | WSON | DSG | 8 | 250 | Green (RoHS & no Sb/Br) | CU NIPDAU | Level-2-260C-1 YEAR | -40 to 125 | T062 |

(1) The marketing status values are defined as follows:

ACTIVE: Product device recommended for new designs.

LIFEBUY: TI has announced that the device will be discontinued, and a lifetime-buy period is in effect.

NRND: Not recommended for new designs. Device is in production to support existing customers, but TI does not recommend using this part in a new design.

PRE_PROD Unannounced device, not in production, not available for mass market, nor on the web, samples not available.

PREVIEW: Device has been announced but is not in production. Samples may or may not be available.

OBSOLETE: TI has discontinued the production of the device.

(2) Eco Plan - The planned eco-friendly classification: Pb-Free (RoHS), Pb-Free (RoHS Exempt), or Green (RoHS & no Sb/Br) - please check <http://www.ti.com/productcontent> for the latest availability information and additional product content details.

TBD: The Pb-Free/Green conversion plan has not been defined.

Pb-Free (RoHS): TI's terms "Lead-Free" or "Pb-Free" mean semiconductor products that are compatible with the current RoHS requirements for all 6 substances, including the requirement that lead not exceed 0.1% by weight in homogeneous materials. Where designed to be soldered at high temperatures, TI Pb-Free products are suitable for use in specified lead-free processes.

Pb-Free (RoHS Exempt): This component has a RoHS exemption for either 1) lead-based flip-chip solder bumps used between the die and package, or 2) lead-based die adhesive used between the die and leadframe. The component is otherwise considered Pb-Free (RoHS compatible) as defined above.

Green (RoHS & no Sb/Br): TI defines "Green" to mean Pb-Free (RoHS compatible), and free of Bromine (Br) and Antimony (Sb) based flame retardants (Br or Sb do not exceed 0.1% by weight in homogeneous material)

(3) Lead/Ball Finish - Orderable Devices may have multiple material finish options. Finish options are separated by a vertical ruled line. Lead/Ball Finish values may wrap to two lines if the finish value exceeds the maximum column width.

(4) MSL, Peak Temp. -- The Moisture Sensitivity Level rating according to the JEDEC industry standard classifications, and peak solder temperature.

(5) There may be additional marking, which relates to the logo, the lot trace code information, or the environmental category on the device

(6) Multiple Device markings will be inside parentheses. Only one Device Marking contained in parentheses and separated by a "-" will appear on a device. If a line is indented then it is a continuation of the previous line and the two combined represent the entire Device Marking for that device.

Important Information and Disclaimer: The information provided on this page represents TI's knowledge and belief as of the date that it is provided. TI bases its knowledge and belief on information provided by third parties, and makes no representation or warranty as to the accuracy of such information. Efforts are underway to better integrate information from third parties. TI has taken and continues to take reasonable steps to provide representative and accurate information but may not have conducted destructive testing or chemical analysis on incoming materials and chemicals. TI and TI suppliers consider certain information to be proprietary, and thus CAS numbers and other limited information may not be available for release.

In no event shall TI's liability arising out of such information exceed the total purchase price of the TI part(s) at issue in this document sold by TI to Customer on an annual basis.

13.1.2 Tape and Reel Information

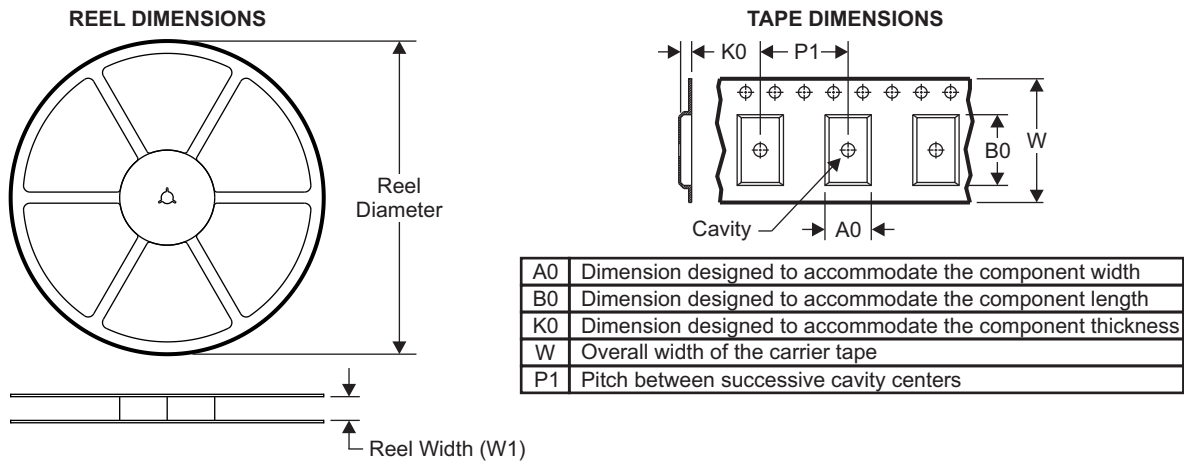

QUADRANT ASSIGNMENTS FOR PIN 1 ORIENTATION IN TAPE

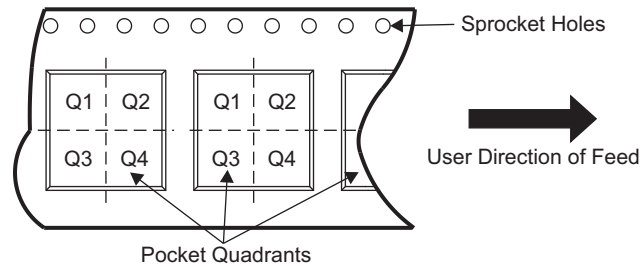

| Device | Package Type | Package Drawing | Pins | SPQ | Reel Diameter (mm) | Reel Width W1 (mm) | A0 (mm) | B0 (mm) | K0 (mm) | P1 (mm) | W (mm) | Pin1 Quadrant |
|--------------|--------------|-----------------|------|------|--------------------|--------------------|---------|---------|---------|---------|--------|---------------|
| TLV9062IDR | SOIC | D | 8 | 2500 | 330.0 | 15.4 | 6.4 | 5.2 | 2.1 | 8.0 | 12.0 | Q1 |
| TLV9062IDSGR | WSON | DSG | 8 | 3000 | 180.0 | 8.4 | 2.3 | 2.3 | 1.15 | 4.0 | 8.0 | Q2 |
| TLV9062IDSGT | WSON | DSG | 8 | 250 | 180.0 | 8.4 | 2.3 | 2.3 | 1.15 | 4.0 | 8.0 | Q2 |

TLV9061, TLV9062, TLV9064

SBOS839B – MARCH 2017 – REVISED OCTOBER 2017

www.ti.com
TAPE AND REEL BOX DIMENSIONS

| Device | Package Type | Package Drawing | Pins | SPQ | Length (mm) | Width (mm) | Height (mm) |
|--------------|--------------|-----------------|------|------|-------------|------------|-------------|
| TLV9062IDR | SOIC | D | 8 | 2500 | 333.2 | 345.9 | 28.6 |
| TLV9062IDSGR | WSON | DSG | 8 | 3000 | 210.0 | 185.0 | 35.0 |
| TLV9062IDSGT | WSON | DSG | 8 | 250 | 210.0 | 185.0 | 35.0 |

PACKAGING INFORMATION

| Orderable Device | Status (1) | Package Type | Package Drawing | Pins | Package Qty | Eco Plan (2) | Lead/Ball Finish (6) | MSL Peak Temp (3) | Op Temp (°C) | Device Marking (4/5) | Samples |
|------------------|---------------|--------------|-----------------|------|-------------|-------------------------|-------------------------|----------------------|--------------|-------------------------|-------------------------|
| PTLV9062IDGKT | ACTIVE | VSSOP | DGK | 8 | 250 | TBD | Call TI | Call TI | -40 to 125 | | Samples |
| PTLV9062IDSGR | ACTIVE | WSON | DSG | 8 | 3000 | TBD | Call TI | Call TI | -40 to 125 | | Samples |
| PTLV9064IDR | ACTIVE | SOIC | D | 14 | 2500 | TBD | Call TI | Call TI | -40 to 125 | | Samples |
| TLV9061IDPWR | PREVIEW | X2SON | DPW | 5 | 3000 | TBD | Call TI | Call TI | -40 to 125 | | |
| TLV9062IDGKT | PREVIEW | VSSOP | DGK | 8 | 250 | TBD | Call TI | Call TI | -40 to 125 | | |
| TLV9062IDR | ACTIVE | SOIC | D | 8 | 2500 | Green (RoHS & no Sb/Br) | CU SN | Level-2-260C-1 YEAR | -40 to 125 | TL9062 | Samples |
| TLV9062IDSGR | PREVIEW | WSON | DSG | 8 | 3000 | Green (RoHS & no Sb/Br) | CU NIPDAU | Level-2-260C-1 YEAR | -40 to 125 | T062 | |
| TLV9062IDSGT | PREVIEW | WSON | DSG | 8 | 250 | Green (RoHS & no Sb/Br) | CU NIPDAU | Level-2-260C-1 YEAR | -40 to 125 | T062 | |
| TLV9064IDR | ACTIVE | SOIC | D | 14 | 2500 | Green (RoHS & no Sb/Br) | CU NIPD | Level-2-260C-1 YEAR | -40 to 125 | TLV9064D | Samples |

(1) The marketing status values are defined as follows:

ACTIVE: Product device recommended for new designs.

LIFEBUY: TI has announced that the device will be discontinued, and a lifetime-buy period is in effect.

NRND: Not recommended for new designs. Device is in production to support existing customers, but TI does not recommend using this part in a new design.

PREVIEW: Device has been announced but is not in production. Samples may or may not be available.

OBSELETE: TI has discontinued the production of the device.

(2) **RoHS:** TI defines "RoHS" to mean semiconductor products that are compliant with the current EU RoHS requirements for all 10 RoHS substances, including the requirement that RoHS substance do not exceed 0.1% by weight in homogeneous materials. Where designed to be soldered at high temperatures, "RoHS" products are suitable for use in specified lead-free processes. TI may reference these types of products as "Pb-Free".

RoHS Exempt: TI defines "RoHS Exempt" to mean products that contain lead but are compliant with EU RoHS pursuant to a specific EU RoHS exemption.

Green: TI defines "Green" to mean the content of Chlorine (Cl) and Bromine (Br) based flame retardants meet JS709B low halogen requirements of <=1000ppm threshold. Antimony trioxide based flame retardants must also meet the <=1000ppm threshold requirement.

(3) MSL, Peak Temp. - The Moisture Sensitivity Level rating according to the JEDEC industry standard classifications, and peak solder temperature.

(4) There may be additional marking, which relates to the logo, the lot trace code information, or the environmental category on the device.

⁽⁵⁾ Multiple Device Markings will be inside parentheses. Only one Device Marking contained in parentheses and separated by a "-" will appear on a device. If a line is indented then it is a continuation of the previous line and the two combined represent the entire Device Marking for that device.

⁽⁶⁾ Lead/Ball Finish - Orderable Devices may have multiple material finish options. Finish options are separated by a vertical ruled line. Lead/Ball Finish values may wrap to two lines if the finish value exceeds the maximum column width.

Important Information and Disclaimer:The information provided on this page represents TI's knowledge and belief as of the date that it is provided. TI bases its knowledge and belief on information provided by third parties, and makes no representation or warranty as to the accuracy of such information. Efforts are underway to better integrate information from third parties. TI has taken and continues to take reasonable steps to provide representative and accurate information but may not have conducted destructive testing or chemical analysis on incoming materials and chemicals. TI and TI suppliers consider certain information to be proprietary, and thus CAS numbers and other limited information may not be available for release.

In no event shall TI's liability arising out of such information exceed the total purchase price of the TI part(s) at issue in this document sold by TI to Customer on an annual basis.

TAPE AND REEL INFORMATION

QUADRANT ASSIGNMENTS FOR PIN 1 ORIENTATION IN TAPE

*All dimensions are nominal

| Device | Package Type | Package Drawing | Pins | SPQ | Reel Diameter (mm) | Reel Width W1 (mm) | A0 (mm) | B0 (mm) | K0 (mm) | P1 (mm) | W (mm) | Pin1 Quadrant |
|--------------|--------------|-----------------|------|------|--------------------|--------------------|---------|---------|---------|---------|--------|---------------|
| TLV9062IDR | SOIC | D | 8 | 2500 | 330.0 | 15.4 | 6.4 | 5.2 | 2.1 | 8.0 | 12.0 | Q1 |
| TLV9062IDSGR | WSON | DSG | 8 | 3000 | 180.0 | 8.4 | 2.3 | 2.3 | 1.15 | 4.0 | 8.0 | Q2 |
| TLV9062IDSGT | WSON | DSG | 8 | 250 | 180.0 | 8.4 | 2.3 | 2.3 | 1.15 | 4.0 | 8.0 | Q2 |
| TLV9064IDR | SOIC | D | 14 | 2500 | 330.0 | 15.4 | 6.4 | 5.2 | 2.1 | 8.0 | 12.0 | Q1 |

TAPE AND REEL BOX DIMENSIONS

*All dimensions are nominal

| Device | Package Type | Package Drawing | Pins | SPQ | Length (mm) | Width (mm) | Height (mm) |
|--------------|--------------|-----------------|------|------|-------------|------------|-------------|
| TLV9062IDR | SOIC | D | 8 | 2500 | 333.2 | 345.9 | 28.6 |
| TLV9062IDSGR | WSON | DSG | 8 | 3000 | 210.0 | 185.0 | 35.0 |
| TLV9062IDSGT | WSON | DSG | 8 | 250 | 210.0 | 185.0 | 35.0 |
| TLV9064IDR | SOIC | D | 14 | 2500 | 336.6 | 336.6 | 41.3 |

DGK (S-PDSO-G8)

PLASTIC SMALL-OUTLINE PACKAGE



4073329/E 05/06

- NOTES:
- A. All linear dimensions are in millimeters.
 - B. This drawing is subject to change without notice.
 - C. Body length does not include mold flash, protrusions, or gate burrs. Mold flash, protrusions, or gate burrs shall not exceed 0.15 per end.
 - D. Body width does not include interlead flash. Interlead flash shall not exceed 0.50 per side.
 - E. Falls within JEDEC MO-187 variation AA, except interlead flash.

D (R-PDSO-G14)

PLASTIC SMALL OUTLINE



- NOTES:
- A. All linear dimensions are in inches (millimeters).
 - B. This drawing is subject to change without notice.
 - $\triangle C$ Body length does not include mold flash, protrusions, or gate burrs. Mold flash, protrusions, or gate burrs shall not exceed 0.006 (0,15) each side.
 - $\triangle D$ Body width does not include interlead flash. Interlead flash shall not exceed 0.017 (0,43) each side.
 - E. Reference JEDEC MS-012 variation AB.

GENERIC PACKAGE VIEW

DSG 8

WSON - 0.8 mm max height

PLASTIC SMALL OUTLINE - NO LEAD

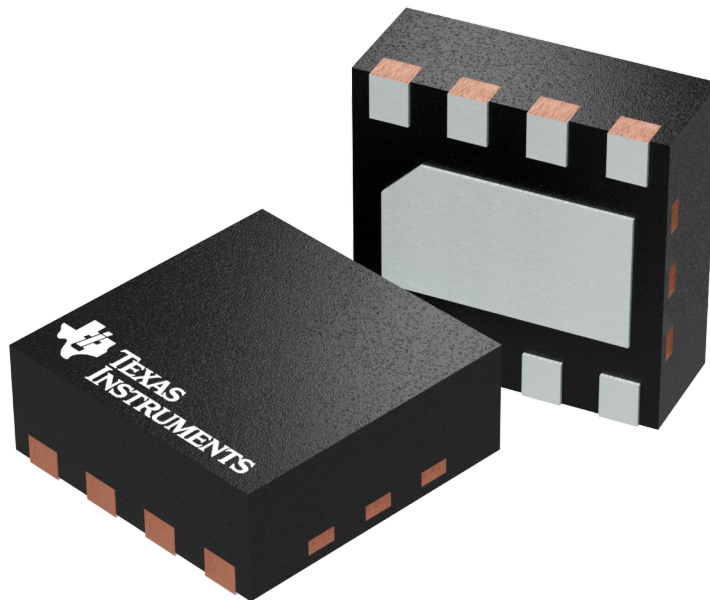

Images above are just a representation of the package family, actual package may vary.
Refer to the product data sheet for package details.

4208210/C

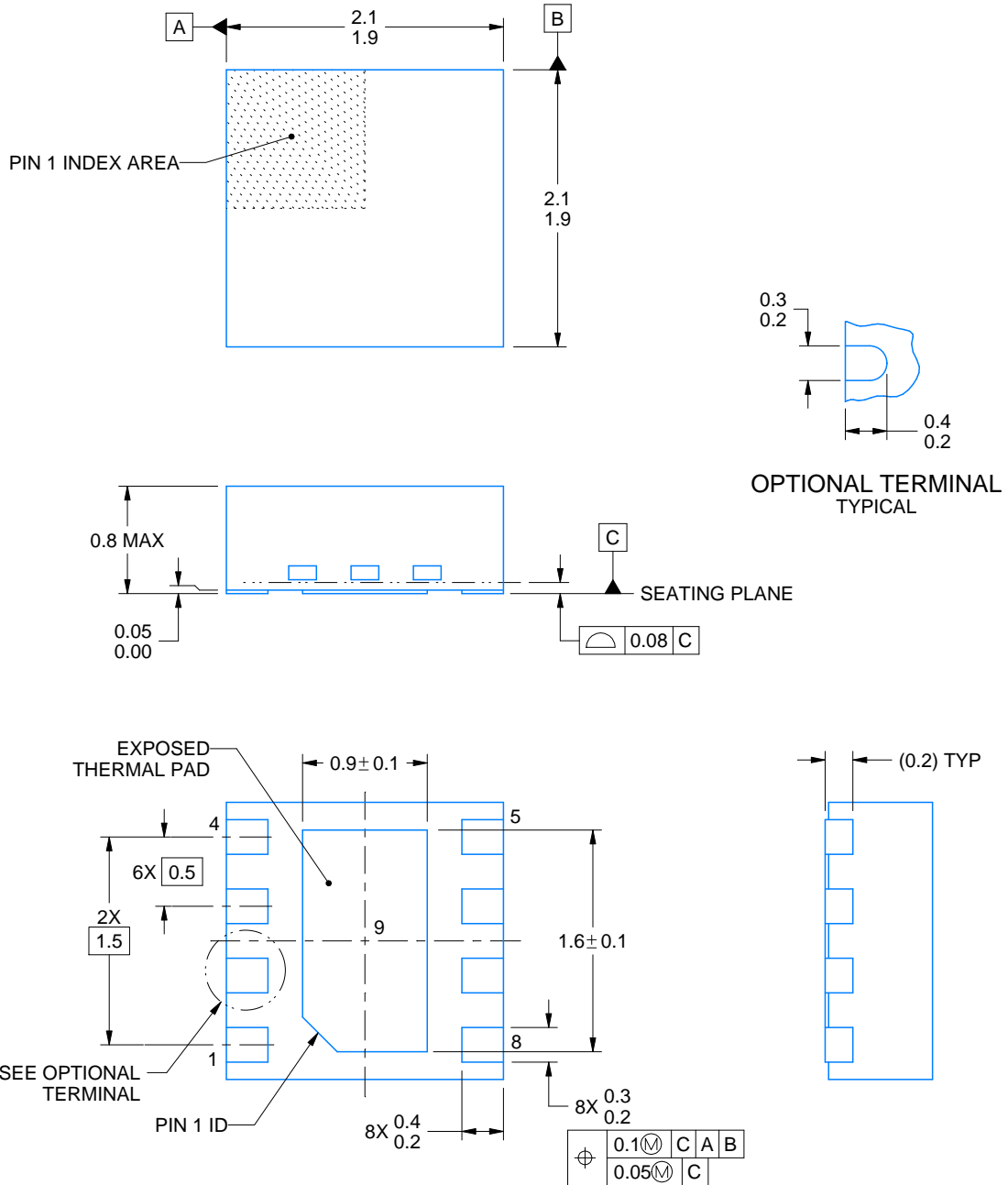
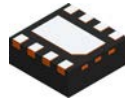

4218900/B 09/2017

NOTES:

1. All linear dimensions are in millimeters. Any dimensions in parenthesis are for reference only. Dimensioning and tolerancing per ASME Y14.5M.
2. This drawing is subject to change without notice.
3. The package thermal pad must be soldered to the printed circuit board for thermal and mechanical performance.

EXAMPLE BOARD LAYOUT

DSG0008A

WSON - 0.8 mm max height

PLASTIC SMALL OUTLINE - NO LEAD

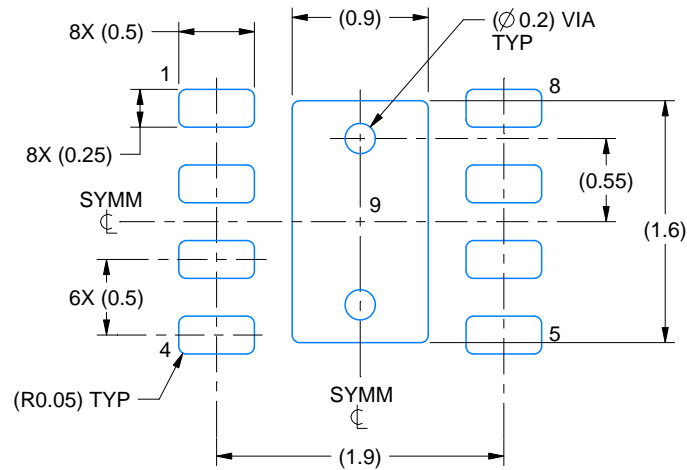

LAND PATTERN EXAMPLE
SCALE:20X

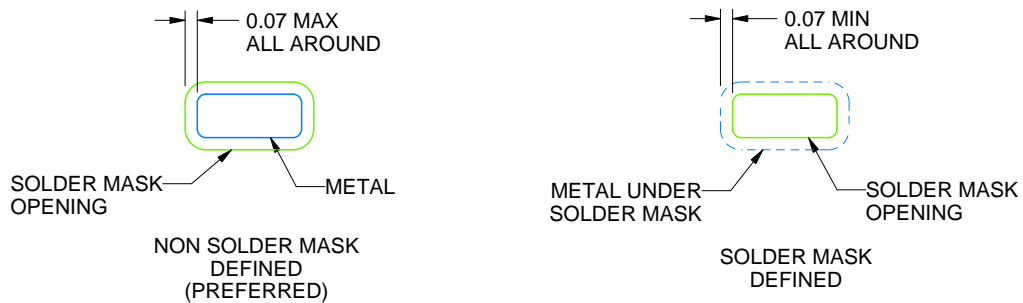

SOLDER MASK DETAILS

4218900/B 09/2017

NOTES: (continued)

4. This package is designed to be soldered to a thermal pad on the board. For more information, see Texas Instruments literature number SLUA271 (www.ti.com/lit/slua271).
5. Vias are optional depending on application, refer to device data sheet. If any vias are implemented, refer to their locations shown on this view. It is recommended that vias under paste be filled, plugged or tented.

EXAMPLE STENCIL DESIGN

DSG0008A

WSON - 0.8 mm max height

PLASTIC SMALL OUTLINE - NO LEAD

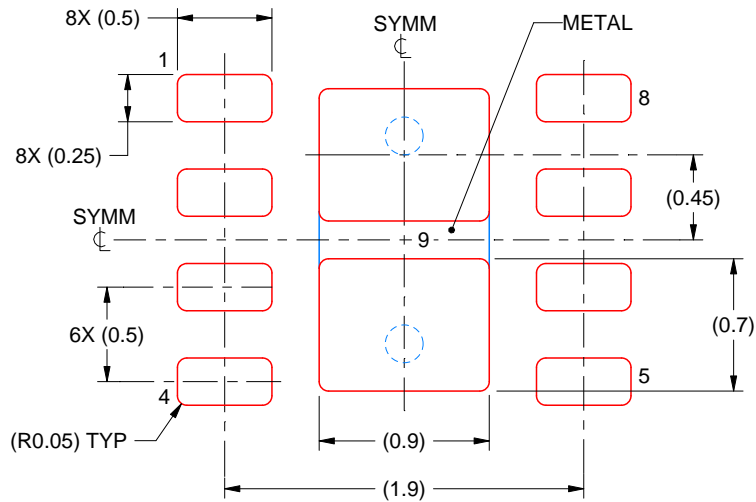

SOLDER PASTE EXAMPLE
BASED ON 0.125 mm THICK STENCIL

EXPOSED PAD 9:
87% PRINTED SOLDER COVERAGE BY AREA UNDER PACKAGE
SCALE:25X

4218900/B 09/2017

NOTES: (continued)

6. Laser cutting apertures with trapezoidal walls and rounded corners may offer better paste release. IPC-7525 may have alternate design recommendations.

GENERIC PACKAGE VIEW

DPW 5

X2SON - 0.4 mm max height

PLASTIC SMALL OUTLINE - NO LEAD



Images above are just a representation of the package family, actual package may vary.
Refer to the product data sheet for package details.

4211218-3/D

D (R-PDSO-G8)

PLASTIC SMALL OUTLINE



- NOTES:
- A. All linear dimensions are in inches (millimeters).
 - B. This drawing is subject to change without notice.
 - $\triangle C$ Body length does not include mold flash, protrusions, or gate burrs. Mold flash, protrusions, or gate burrs shall not exceed 0.006 (0,15) each side.
 - $\triangle D$ Body width does not include interlead flash. Interlead flash shall not exceed 0.017 (0,43) each side.
 - E. Reference JEDEC MS-012 variation AA.

IMPORTANT NOTICE

Texas Instruments Incorporated (TI) reserves the right to make corrections, enhancements, improvements and other changes to its semiconductor products and services per JESD46, latest issue, and to discontinue any product or service per JESD48, latest issue. Buyers should obtain the latest relevant information before placing orders and should verify that such information is current and complete.

TI's published terms of sale for semiconductor products (<http://www.ti.com/sc/docs/stdterms.htm>) apply to the sale of packaged integrated circuit products that TI has qualified and released to market. Additional terms may apply to the use or sale of other types of TI products and services.

Reproduction of significant portions of TI information in TI data sheets is permissible only if reproduction is without alteration and is accompanied by all associated warranties, conditions, limitations, and notices. TI is not responsible or liable for such reproduced documentation. Information of third parties may be subject to additional restrictions. Resale of TI products or services with statements different from or beyond the parameters stated by TI for that product or service voids all express and any implied warranties for the associated TI product or service and is an unfair and deceptive business practice. TI is not responsible or liable for any such statements.

Buyers and others who are developing systems that incorporate TI products (collectively, "Designers") understand and agree that Designers remain responsible for using their independent analysis, evaluation and judgment in designing their applications and that Designers have full and exclusive responsibility to assure the safety of Designers' applications and compliance of their applications (and of all TI products used in or for Designers' applications) with all applicable regulations, laws and other applicable requirements. Designer represents that, with respect to their applications, Designer has all the necessary expertise to create and implement safeguards that (1) anticipate dangerous consequences of failures, (2) monitor failures and their consequences, and (3) lessen the likelihood of failures that might cause harm and take appropriate actions. Designer agrees that prior to using or distributing any applications that include TI products, Designer will thoroughly test such applications and the functionality of such TI products as used in such applications.

TI's provision of technical, application or other design advice, quality characterization, reliability data or other services or information, including, but not limited to, reference designs and materials relating to evaluation modules, (collectively, "TI Resources") are intended to assist designers who are developing applications that incorporate TI products; by downloading, accessing or using TI Resources in any way, Designer (individually or, if Designer is acting on behalf of a company, Designer's company) agrees to use any particular TI Resource solely for this purpose and subject to the terms of this Notice.

TI's provision of TI Resources does not expand or otherwise alter TI's applicable published warranties or warranty disclaimers for TI products, and no additional obligations or liabilities arise from TI providing such TI Resources. TI reserves the right to make corrections, enhancements, improvements and other changes to its TI Resources. TI has not conducted any testing other than that specifically described in the published documentation for a particular TI Resource.

Designer is authorized to use, copy and modify any individual TI Resource only in connection with the development of applications that include the TI product(s) identified in such TI Resource. NO OTHER LICENSE, EXPRESS OR IMPLIED, BY ESTOPPEL OR OTHERWISE TO ANY OTHER TI INTELLECTUAL PROPERTY RIGHT, AND NO LICENSE TO ANY TECHNOLOGY OR INTELLECTUAL PROPERTY RIGHT OF TI OR ANY THIRD PARTY IS GRANTED HEREIN, including but not limited to any patent right, copyright, mask work right, or other intellectual property right relating to any combination, machine, or process in which TI products or services are used. Information regarding or referencing third-party products or services does not constitute a license to use such products or services, or a warranty or endorsement thereof. Use of TI Resources may require a license from a third party under the patents or other intellectual property of the third party, or a license from TI under the patents or other intellectual property of TI.

TI RESOURCES ARE PROVIDED "AS IS" AND WITH ALL FAULTS. TI DISCLAIMS ALL OTHER WARRANTIES OR REPRESENTATIONS, EXPRESS OR IMPLIED, REGARDING RESOURCES OR USE THEREOF, INCLUDING BUT NOT LIMITED TO ACCURACY OR COMPLETENESS, TITLE, ANY EPIDEMIC FAILURE WARRANTY AND ANY IMPLIED WARRANTIES OF MERCHANTABILITY, FITNESS FOR A PARTICULAR PURPOSE, AND NON-INFRINGEMENT OF ANY THIRD PARTY INTELLECTUAL PROPERTY RIGHTS. TI SHALL NOT BE LIABLE FOR AND SHALL NOT DEFEND OR INDEMNIFY DESIGNER AGAINST ANY CLAIM, INCLUDING BUT NOT LIMITED TO ANY INFRINGEMENT CLAIM THAT RELATES TO OR IS BASED ON ANY COMBINATION OF PRODUCTS EVEN IF DESCRIBED IN TI RESOURCES OR OTHERWISE. IN NO EVENT SHALL TI BE LIABLE FOR ANY ACTUAL, DIRECT, SPECIAL, COLLATERAL, INDIRECT, PUNITIVE, INCIDENTAL, CONSEQUENTIAL OR EXEMPLARY DAMAGES IN CONNECTION WITH OR ARISING OUT OF TI RESOURCES OR USE THEREOF, AND REGARDLESS OF WHETHER TI HAS BEEN ADVISED OF THE POSSIBILITY OF SUCH DAMAGES.

Unless TI has explicitly designated an individual product as meeting the requirements of a particular industry standard (e.g., ISO/TS 16949 and ISO 26262), TI is not responsible for any failure to meet such industry standard requirements.

Where TI specifically promotes products as facilitating functional safety or as compliant with industry functional safety standards, such products are intended to help enable customers to design and create their own applications that meet applicable functional safety standards and requirements. Using products in an application does not by itself establish any safety features in the application. Designers must ensure compliance with safety-related requirements and standards applicable to their applications. Designer may not use any TI products in life-critical medical equipment unless authorized officers of the parties have executed a special contract specifically governing such use. Life-critical medical equipment is medical equipment where failure of such equipment would cause serious bodily injury or death (e.g., life support, pacemakers, defibrillators, heart pumps, neurostimulators, and implantables). Such equipment includes, without limitation, all medical devices identified by the U.S. Food and Drug Administration as Class III devices and equivalent classifications outside the U.S.

TI may expressly designate certain products as completing a particular qualification (e.g., Q100, Military Grade, or Enhanced Product). Designers agree that it has the necessary expertise to select the product with the appropriate qualification designation for their applications and that proper product selection is at Designers' own risk. Designers are solely responsible for compliance with all legal and regulatory requirements in connection with such selection.

Designer will fully indemnify TI and its representatives against any damages, costs, losses, and/or liabilities arising out of Designer's non-compliance with the terms and provisions of this Notice.