

High Efficiency Integrated Driver for 4-Strings of 150mA LEDs

POWER MANAGEMENT Features

- Wide input voltage range from 4.5V to 27V
- 42V maximum output voltage
- Drives up to 40 WLEDs in 4 strings
- **Programmable LED current for up to 150mA per string**
- **+/- 2% string-to-string current matching**
- **Up to 90% efficiency**
- Wide 0.2% to 100% PWM dimming range
- Possible analog dimming
- Integrated 3.0A power switch
- 700KHz switching frequency for small size
- Adjustable OVP for cost-effective output cap selection
- **Open/short LED protection**
- **Short LED protection disable**
- Thermal protection with auto-recovery
- Thermally enhanced TSSOP-20 EDP package
- Lead-free, Halogen-Free and WeEE/RoHS Compliant

Applications

- Medium-sized LCD panel
- Notebook Display
- Automotive Car Navigation Display
- Sub-Notebook and Tablet Computer Displays
- Portable Media Players

Description

The SC441D is a high-efficiency multiple string WLED driver with an integrated boost converter. It operates over a wide input range from 4.5V to 27V with a maximum output voltage of 42V and a 3.0A internal power switch. It can drive up to forty WLEDs in 4 strings with current up to 150mA per string. The string-to-string current matching is 2% typical, 3% maximum. The overall efficiency is greater than 90% due to the low current sense voltage and a low-impedance internal power switch. The wide PWM dimming range boasts a ratio of 500: 1.

The 700KHz switching frequency enables the user to optimize the external component sizes for efficiency. When there are fewer than 10 LEDs in each string, users can adjust the output voltage protection yielding an allowable reduction in associated costs, size and voltage ratings of the output capacitor.

The SC441D also features comprehensive open and short-circuit LED protection functions. It disables the corresponding strings with LED open or LED short conditions while maintaining normal operation of other, unaffected LED strings. This feature allows LCD panels to remain viewable even under LED failure, wire disconnect, or short-circuit conditions. The internal thermal shutdown protects the IC from overheating at abnormal conditions.

The SC441D is available in a thermally-enhanced TSSOP-20 EDP package.

Typical Application Circuit

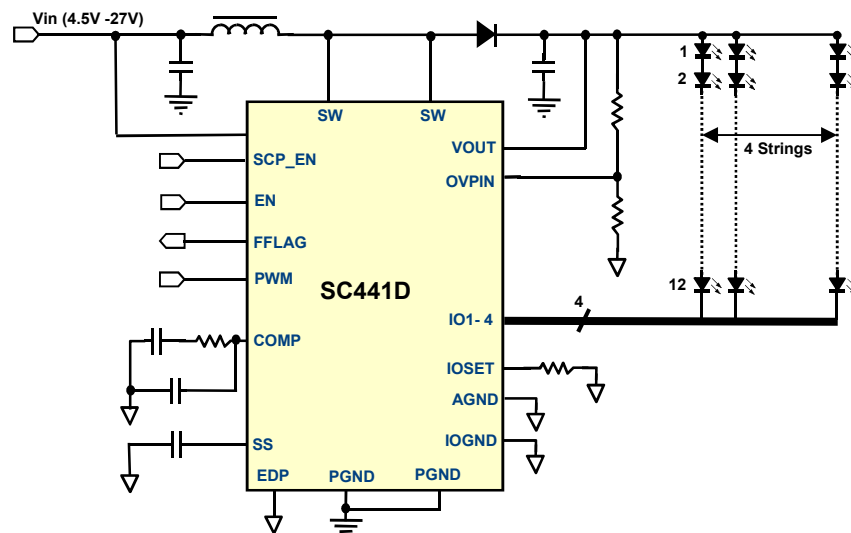

Pin Configuration

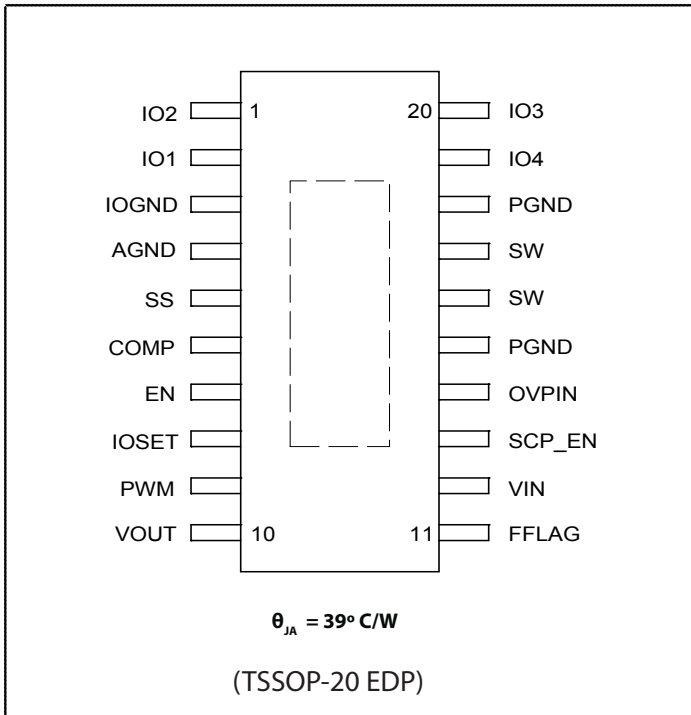

Ordering Information

Device	Package
SC441DTETRT ^(1,2)	TSSOP-20 EDP
SC441DEVB	Evaluation Board

Notes:

- (1) Available in tape and reel only. A reel contains 2,500 devices.
- (2) Available in lead-free package only. Device is WEEE/RoHS compliant and halogen-free.

Marking Information

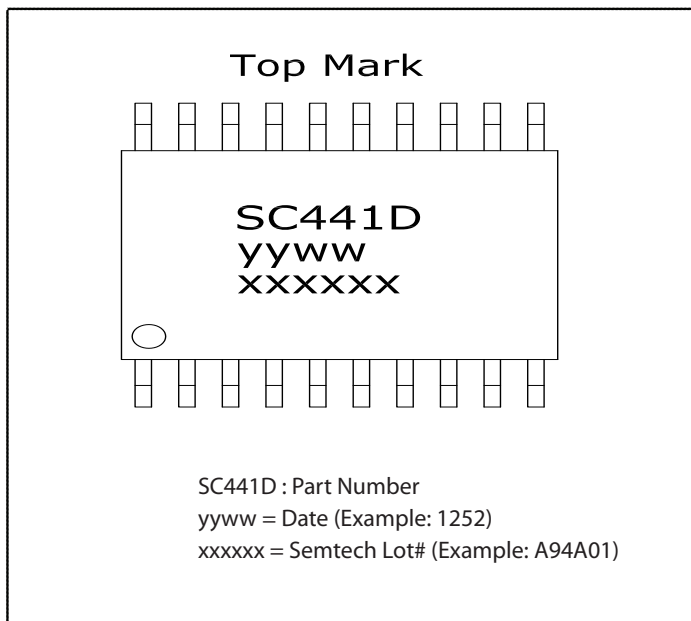

Absolute Maximum Ratings

V_{IN} Pin: Supply Voltage	-0.3 to 30V
Maximum Output Power	22W
SW, OVPIN,, VOUT, IO1~IO4 Voltage	-0.3 to 45V
IOSET Voltage	-0.3 to 2V
SS, COMP Voltage	-0.3 to 4V
EN, PWM, FFLAG Voltage	-0.3 to $V_{IN} + 0.3V$
PGND to AGND	$\pm 0.3V$
Peak IR Reflow Temperature	260°C
ESD Protection Level ⁽²⁾	2.5kV

Recommended Operating Conditions

Input Voltage Range	4.5V~27V
Output Voltage	Up to 42V
LED Current	Up to 150mA

Thermal Information

Junction to Ambient ⁽¹⁾	39°C/W
Maximum Junction Temperature	150°C
Storage Temperature	-65 to +150°C
Lead Temperature (Soldering) 10 sec	260°C

Exceeding the above specifications may result in permanent damage to the device or device malfunction. Operation outside of the parameters specified in the Electrical Characteristics section is not recommended.

NOTES-

(1) Calculated from package in still air, mounted to 3" x 4.5", 4 layer FR4 PCB with thermal vias under the exposed pad per JESD51 standards.

(2) Tested according to JEDEC standard JESD22-A114-B.

Electrical Characteristics

Unless otherwise specified: $V_{IN} = 12V$, $-40^{\circ}C < T_A = T_J < 105^{\circ}C$, $R_{IOSET} = 1.74k\Omega$.

Parameter	Symbol	Conditions	Min	Typ	Max	Units
Input Supply						
Under-Voltage Lockout Threshold	UVLO-TH	V_{IN} rising		4.3	4.45	V
UVLO Hysteresis	UVLO-H			250		mV
V_{IN} Quiescent Supply Current	I_{IN_Q}	No switching		3		mA
V_{IN} Supply Current in Shutdown	I_{IN_S}	EN / PWM = low			1	μA
Oscillator						
Switching Frequency	F_S		0.56	0.7	0.84	MHz
Internal Power Switcher						
Switch Current Limit	I_{SW}		3.0	4.1		A
Switch Saturation Voltage	V_{SAT}	$I_{SW} = 1A$		200	350	mV
Switch Leakage Current	I_{S_LEAK}			0.1	5	μA
Maximum Duty Cycle	D_{MAX}		88	93		%
Minimum Duty Cycle	D_{MIN}				0	%
Minimum On-Time ⁽¹⁾	T_{ON_MIN}			100		ns

Electrical Characteristics (continued)

Parameter	Symbol	Conditions	Min	Typ	Max	Units
Compensation						
Sourcing Current	I_{EA_SOURCE}	$V_{COMP} = 0.5V$		5		μA
Sinking Current	I_{EA_SINK}	$V_{COMP} = 2V$		6		μA
Control Signals						
EN, PWM, SCP_EN High Voltage	V_{EN_H}, V_{PWM_H}		2			V
EN, PWM, SCP_EN Low Voltage	V_{EN_L}, V_{PWM_L}				0.4	V
EN, PWM Leakage Current	I_{EN}, I_{PWM}	$V_{EN}, V_{PWM} = 5V$		0.1	1	μA
PWM Dimming Frequency ⁽¹⁾	$F_{Dimming}$		50		50k	Hz
PWM Dimming Minimum Duty Cycle	$D_{MIN_Dimming}$	$F_{Dimming} = 200Hz$		0.2		%
PWM Dimming Minimum Pulse-Width ⁽²⁾	$T_{MIN_Dimming}$				5	μs
PWM Dimming Minimum Off Time	T_{MIN_Off}			200	300	ns
FFLAG Voltage	V_{FFLAG}	$I_{FFLAG} = 2\text{ mA}$		0.25		V
SS Source Current	I_{SS_SOURCE}	$V_{SS} = 0V$		4.5		μA
SS Sink Current	I_{SS_SINK}	$V_{SS} = 2V$ at OVP or OTP		1		
SS Switching Threshold	$V_{SS_Switching}$	$V_{IN} = 12V, T_J = 25\text{ }^\circ C$	0.5	0.7	1.2	V
SS End Value	V_{SS_END}	$V_{IN} = 12V$		2.5		V
Over-Voltage Protection						
OVPIN Threshold	V_{OVPIN_TH}	OVPIN - AGND	1.46	1.52	1.58	V
OVPIN Leakage Current	I_{OVPIN}	$V_{OVPIN} = 20V$		0.1	1	μA
VOUT Internal Pull-down Current Source	I_{OVP}	$V_{OUT} = V_{IN} + 3V$		0.9		mA
VOUT Leakage Current	I_{VOUT_LEAK}	$V_{OUT} = 40V$		0.1		μA
Current Source (IO1 ~ IO4)						
Current Accuracy	$I_{O1} \sim I_{O4}$	$T_J = 25\text{ }^\circ C$	140	150	160	mA
Current Matching		$T_J = 25\text{ }^\circ C$		+/- 2	+/-3	%
Maximum LED Current	I_{OMAX}		200			mA
LED Short-Circuit Protection Threshold	V_{IO_SCP}	$T_J = 25\text{ }^\circ C$	1			V
Leakage Current	I_{IO_LEAK}	$EN = 0, V_{IO1} \sim V_{IO4} = V_{IN}$		0.1	1	μA

Parameter	Symbol	Conditions	Min	Typ	Max	Units
Overshoot Protection Threshold	$V_{I_{O1} \sim I_{O4}}$	$T_J = 25\text{ }^\circ\text{C}, V_{I_{O1}} \sim V_{I_{O4}}$	0.963	1.07	1.177	V
			0.9095	1.07	1.2305	V
Overshoot Protection Hysteresis	Any of $I_{O1} \sim I_{O4}$			100		mV
LED Short Circuit Protection						
SCPSET Current	I_{SCPSET}		41	51	61	μA
Max. SCPSET Threshold Voltage	V_{SCPSET_MAX}			$V_{IN} - 1$		V
Over-Temperature Protection						
Thermal Shutdown Temperature	T_{OTP}			150		$^\circ\text{C}$
Thermal Shutdown Hysteresis	T_{OTP_H}			30		$^\circ\text{C}$

Notes:

- (1) Guaranteed by design.
- (2) For achievable PWM dimming minimum pulse-width in applications, see the corresponding curves in Typical Characteristics.

Typical Characteristics

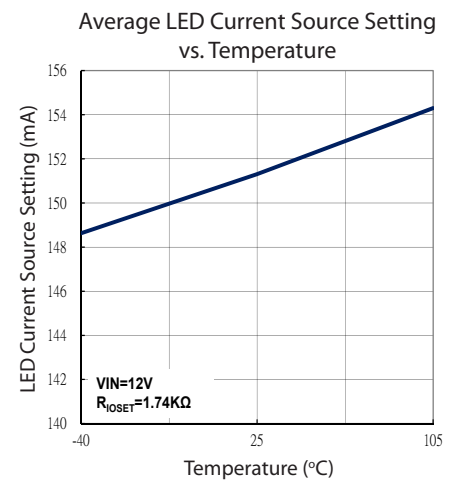
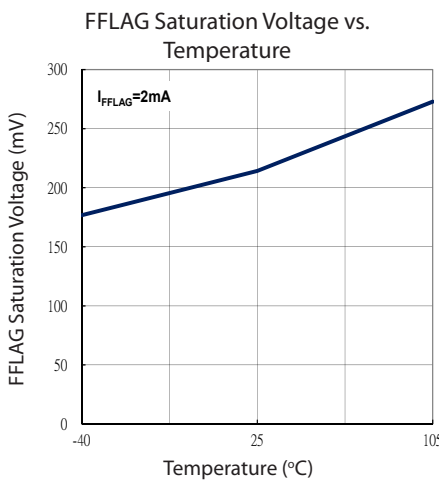
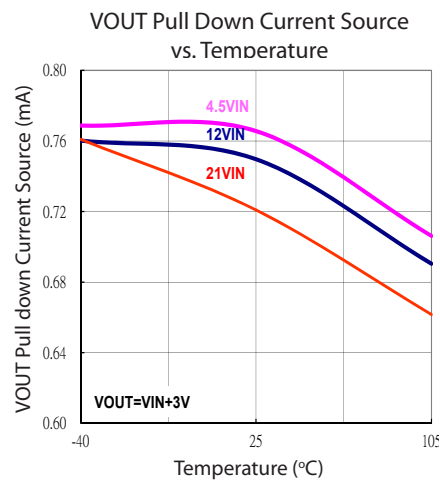
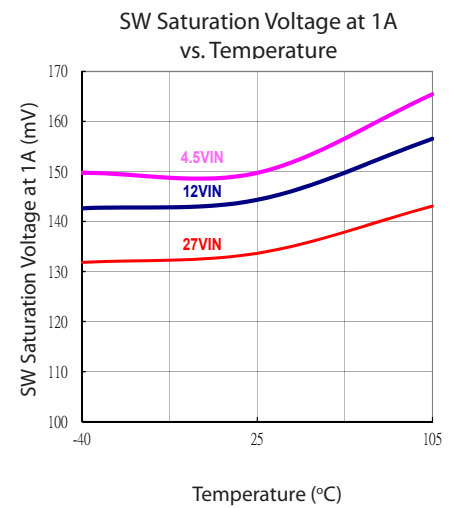
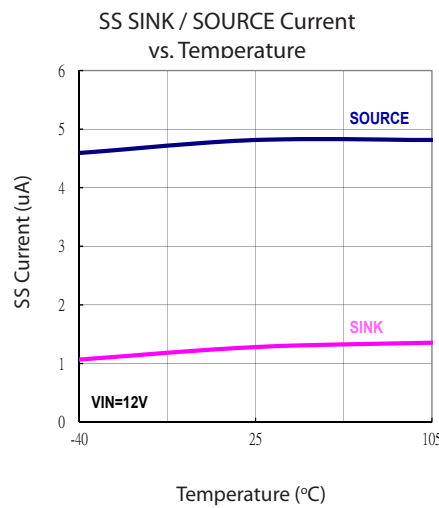
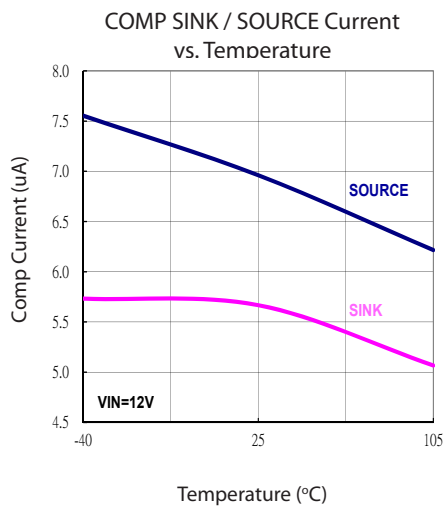
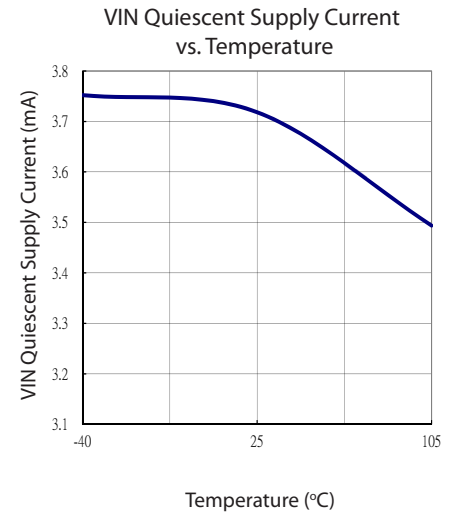
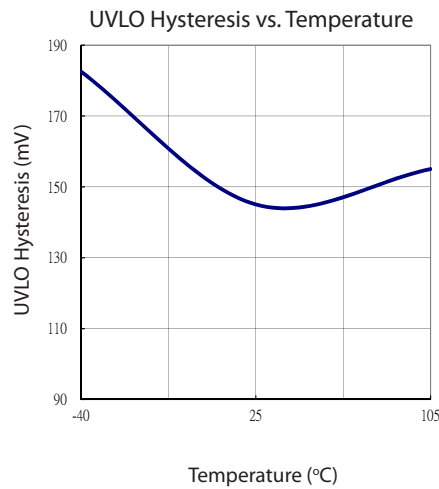
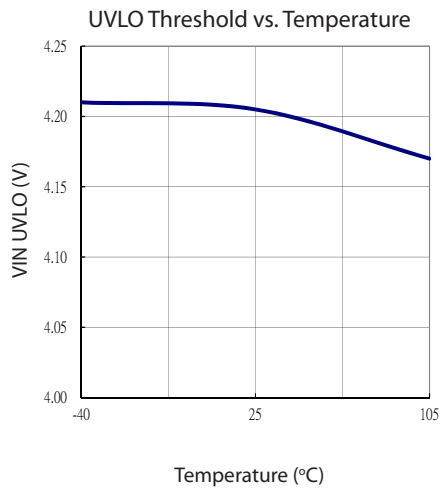

Typical Characteristics (continued)

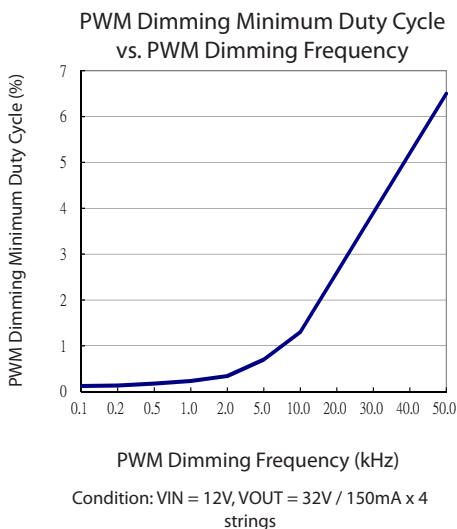
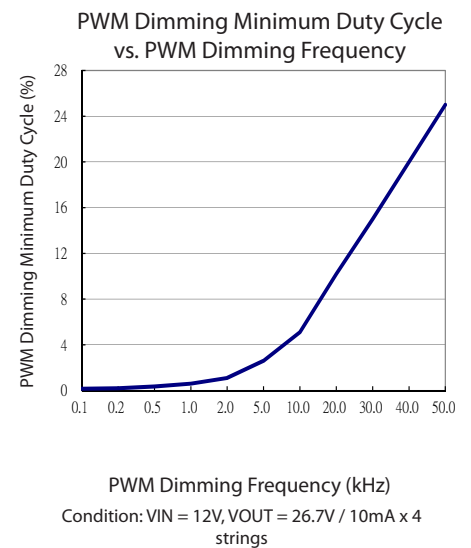
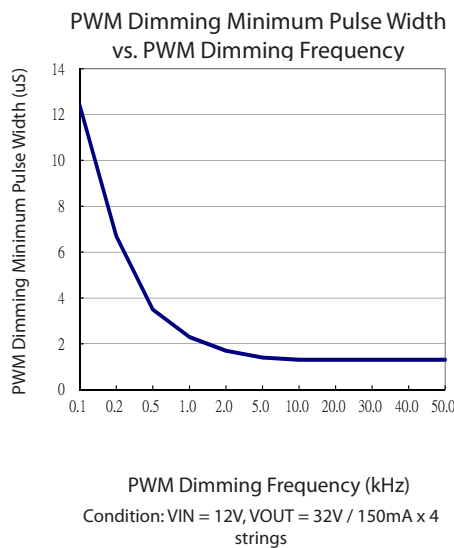
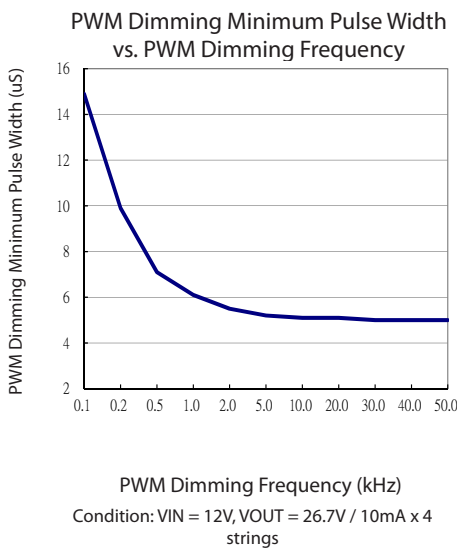
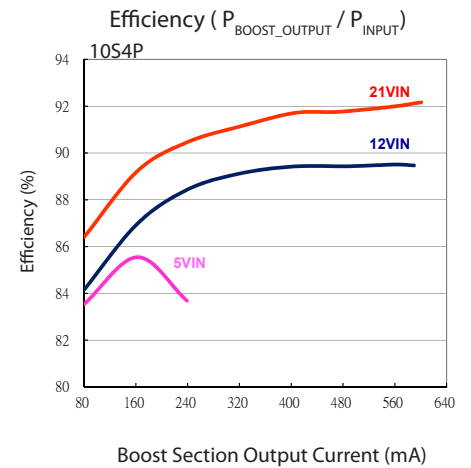
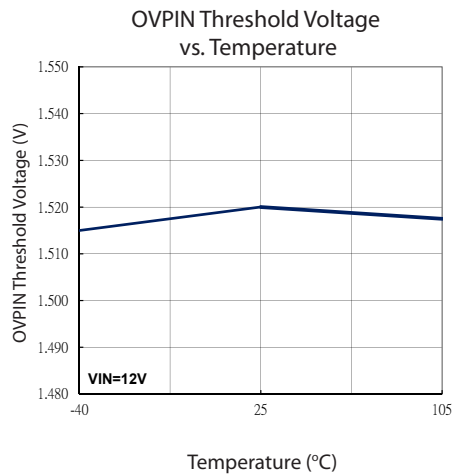
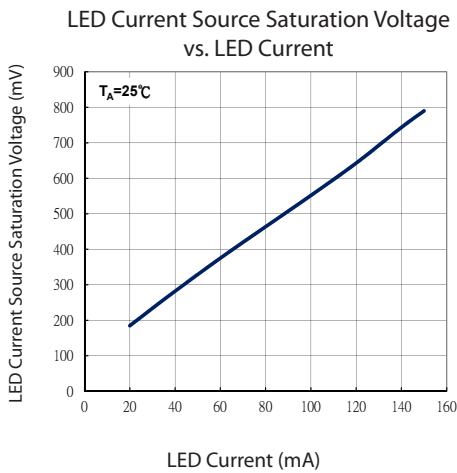

Typical Characteristics (continued)

Start up

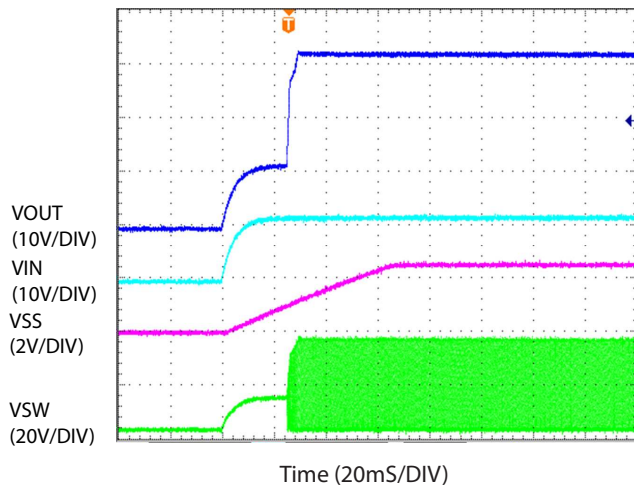

Conditions: VIN = 12V,
Output = 32V / 150mA x 4 LED strings

Shut Down

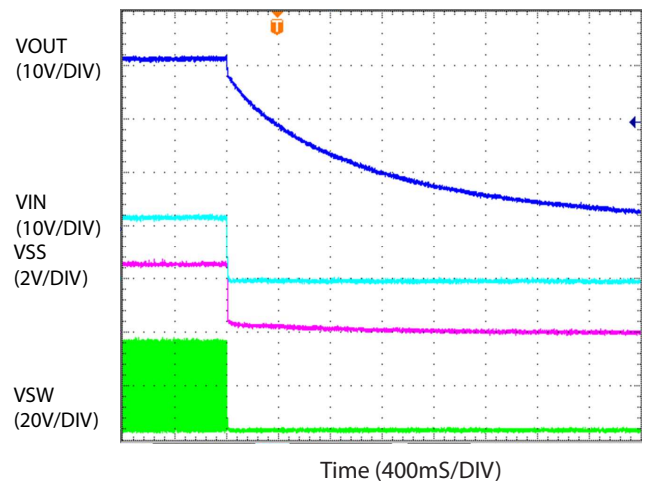

Conditions: VIN = 12V,
Output = 32V / 150mA x 4 LED strings

Main Power Switching Waveform

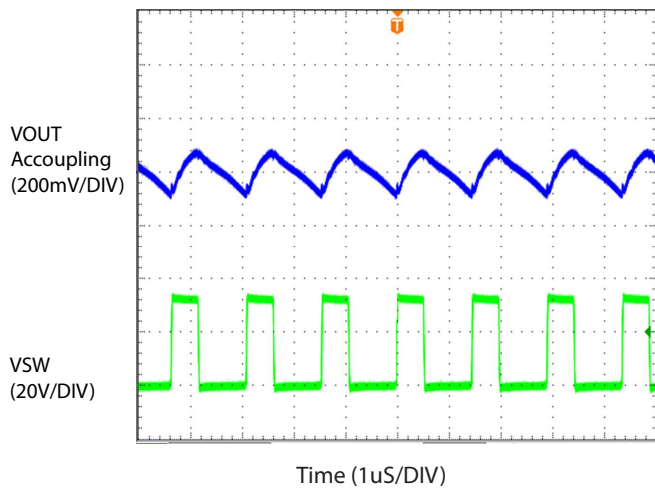

Conditions: VIN = 12V,
Output = 32V / 150mA x 4 LED strings

Main Power Switching Waveform

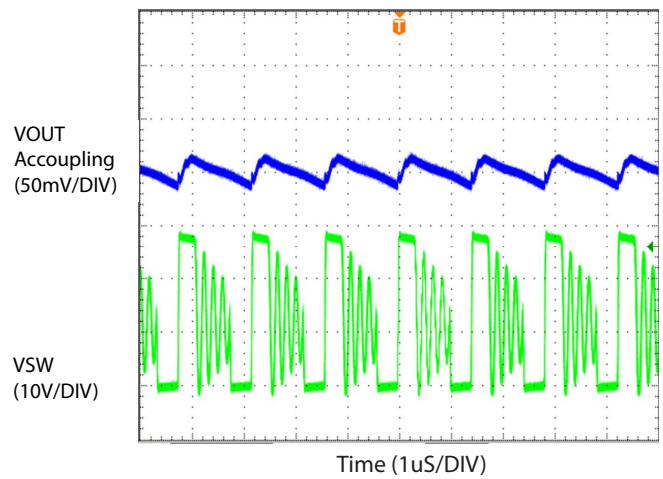

Conditions: VIN = 12V,
Output = 27V / 20mA x 4 LED strings

Typical Characteristics (continued)

OTP and OTP Recovery

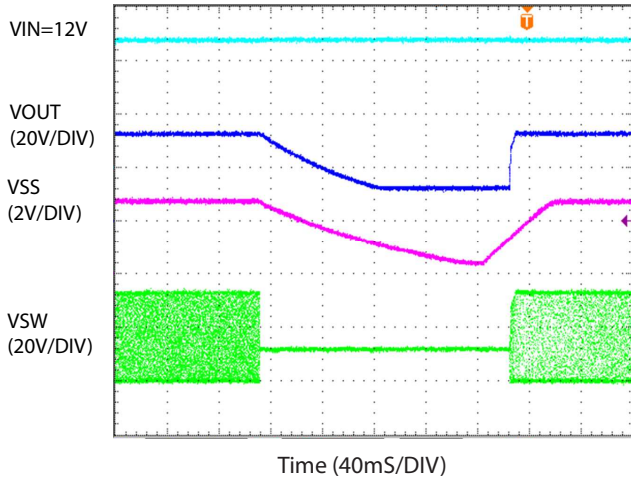

Conditions: VIN = 12V,
Output = 32V / 150mA x 4 LED strings

LED Short Circuit Protection

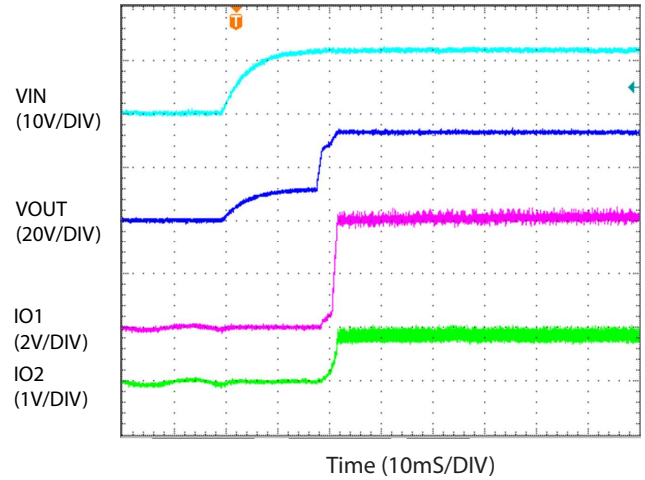

Conditions: VIN = 12V, IO1 has one LED short circuit,
Output = 32V / 150mA x 4 LED strings

LED Open circuit Protection

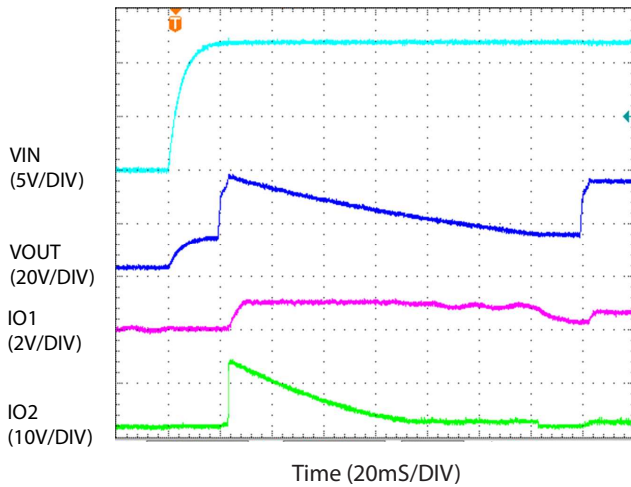

Conditions: VIN = 12V, IO1 LED String is open circuit,
Output = 32V / 150mA x 3 LED strings

PWM Dimming

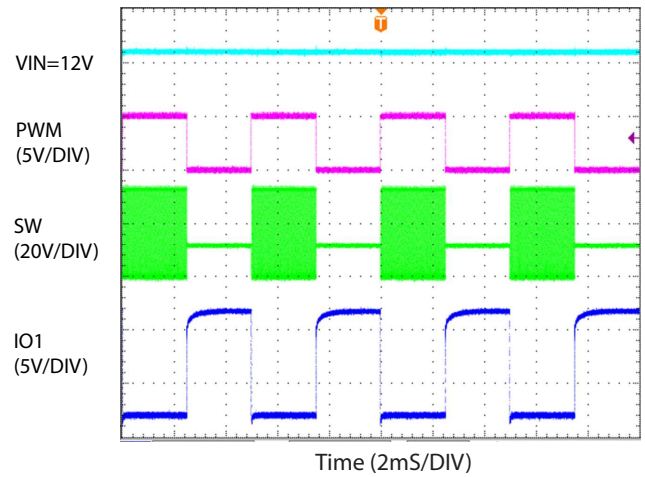

Conditions: VIN = 12V,
Output = 32V / 150mA x 4 LED strings

Pin Descriptions

Pin #	Pin Name	Pin Function
1	IO2	Provides constant current source to LED string 2.
2	IO1	Provides constant current source to LED string 1.
3	IOGND	Constant current source ground.
4	AGND	Analog ground
5	SS	Soft-start pin
6	COMP	The output of the internal trans-conductance error amplifier.
7	EN	Enable the device including regulator and LED drivers.
8	IOSET	Current source IO value set pin. By selecting the resistor connected from this pin to GND, the corresponding maximum current on all 4 strings are set.
9	PWM	PWM dimming control pin for LED strings.
10	VOUT	Internal pull down current source in over voltage fault. Connect this pin directly to Boost output.
11	FFLAG	Power failure signal output with open collector. Held low under normal operation.
12	VIN	Power input voltage pin. Bypassed with capacitors close to the pin.
13	SCP_EN	O LED short-circuit protection pin – leaving this pin open enables the function, tying it to ground disables it. If any IO pin connects to VIN, SCP_EN needs to be left open to activate the protection.
14	OVPIN	Over-Voltage Protection sense signal input.
15,18	PGND	Power ground
16,17	SW	Collector of the internal power switch.
19	IO4	Provides constant current source to LED string 4. Connect to VIN for 3 strings operation.
20	IO3	Provides constant current source to LED string 3.
EDP		Solder to the ground plane of the PCB.

Note: Any unused IO pin should be pulled up to VIN.

EN	STATUS
0	backlight disable
1	backlight enable

Note: When EN = 0; the boost is turned OFF and disabled.

Block Diagram

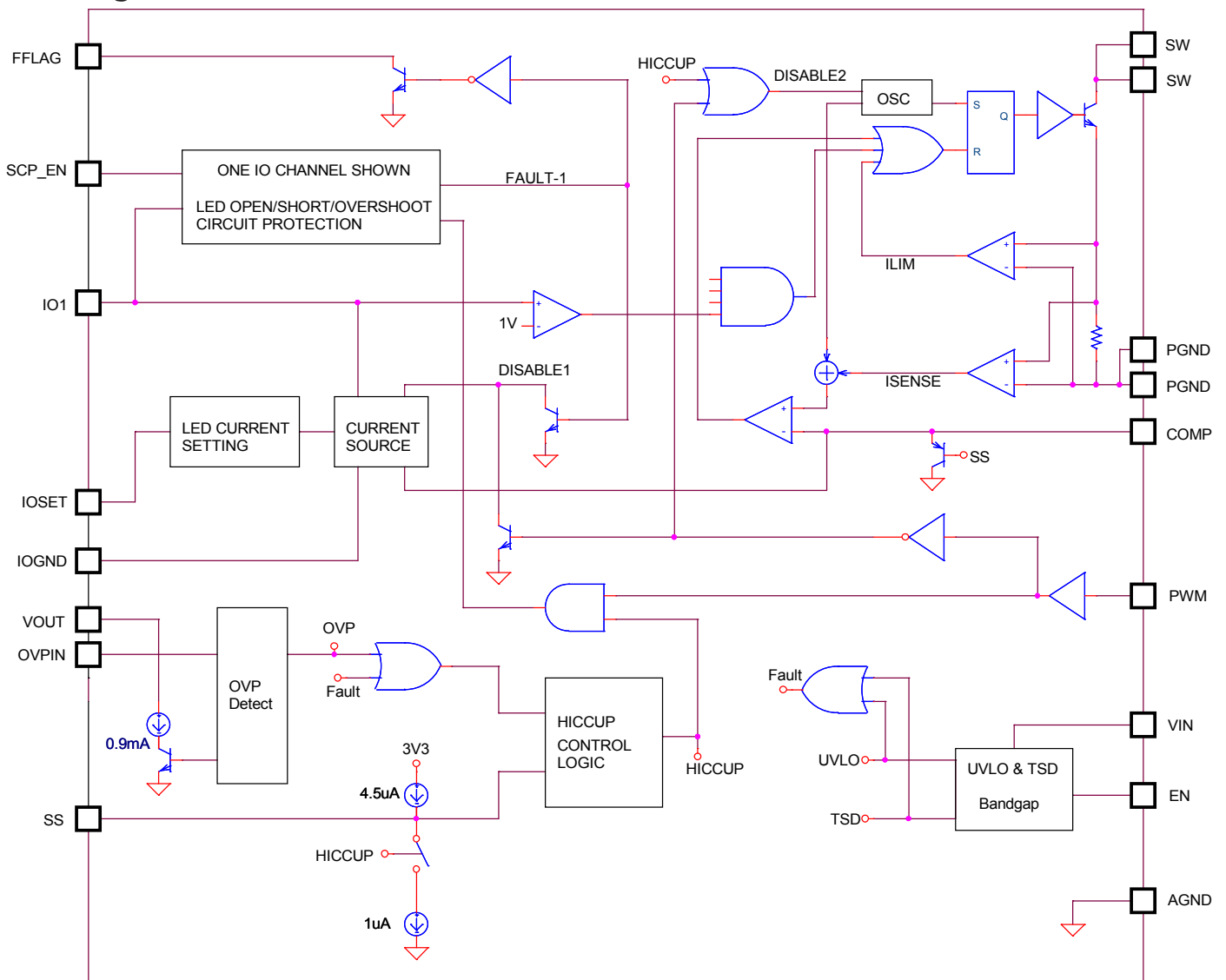

Figure 1. SC441D Block Diagram

Applications Information

SC441D Detailed Description

The SC441D contains a high frequency, current-mode boost regulator and four programmable current sources. The LED current source value is set using an external resistor while the PWM controller maintains the output voltage at a level keeping the current regulated through the LEDs. Since the SC441D receives feedback from all of the LED current sources, all LED strings can be turned on at any given time. A typical application would use 3-10 backlight LEDs for each string, driven up to 150mA.

Operation

The SC441D controls the boost converter set point based on instantaneous requirements of four current sources. Therefore, only a single inductor and power switch is needed to provide power to the entire lighting subsystem, increasing efficiency and reducing part count. A digital interface to output control is high-bandwidth, supporting digital PWM dimming at 50Hz to 50kHz dimming frequency, while aggressively shutting the entire supply current down to 3mA (typical), when all LED strings are turned off.

High frequency switching provides high output power using a tiny 1.0mm high inductor, maximizing efficiency for space-constrained and cost-sensitive applications. Additionally, both converter and output capacitor are protected from open-LED conditions by over-voltage protection.

LED Current Programming

The SC441D features programmable LED current regulators. The LED current set points are chosen using external resistors tied to the IOSET pin. The relationship between the programming resistor value and the output current set point can be described as follows:

$$R_{IOSET} = (0.261V) / I_{LED}$$

Where R_{IOSET} is in k Ω . I_{LED} is the LED current in Amperes. The four output channels have the same output current.

Start-Up

During start-up, when the VIN pin voltage reaches its UVLO threshold and both the EN and PWM signals are set to high, the SS pin begins to source 4.5 μ A as its voltage begins to rise from 0V to its end value of 2.5V. The output voltage of the internal trans-conductance error amplifier (COMP), increases and clamps to the SS pin voltage. When the SS pin voltage reaches its switching threshold, output

voltage increases. Proper decoupling is required on the VIN pin, especially for a lower input voltage condition. A 22 μ F, 6.3V rated X5R ceramic capacitor is recommended for a 5V input system.

The internal LED current source (IO1 ~ IO4) helps to regulate the LED current to its set point while the output voltage increases; a suitable amount of error information will be generated on the internal error amplifier. The COMP pin voltage keeps rising and once the LED current reaches its set point, the error information will not be generated by the LED current source. The COMP pin voltage stays level while keeping the LED current in its set point.

If the EN pin voltage is pulled below 0.4V, the SC441D will stay in shutdown mode drawing less than 1 μ A from its input power supply.

During the normal operation, when PWM pin is pulled below 0.4V, the device operates in standby mode, drawing 3mA (typical) current from the input. Under this condition, since the EN pin is pulled high, soft-start is initiated and the SS pin voltage is raised to its end value. Following this, when the PWM signal goes high to enable the SC441D, the COMP pin voltage will rise quickly since it is not limited by the SS pin. A proper capacitance (10nF ~ 100nF) is required to prevent output voltage overshoot on the COMP pin and its external RC network.

Shut Down

If the VIN pin voltage falls below its UVLO, or the voltage on the EN pin goes low, the device will run in shutdown mode as the internal switch and the LED current sources will immediately turn off. The SS capacitor is discharged by the internal current source of the SS pin. The SS pin voltage decreases to 0V while the output voltage falls to the same level as the input voltage.

If the PWM pin voltage goes low while SC441D is in normal operation, then the SC441D will run in standby mode. The Internal switcher and the LED current source will immediately turn off.

NOTE–

The PWM signal does not affect the SS pin nor its final value.

Main Power Operation

SC441D is a 700KHz fixed-frequency, peak current-mode step-up switching regulator with an integrated 3.0A (minimum) power transistor.

Applications Information (continued)

Referring to the Block Diagram, Figure 1, the clock from the oscillation section resets the latch and turns on the power transistor. Switch current is sensed with an integrated sense resistor. The sensed current is summed with the slope-compensating ramp and fed into the modulating ramp input of the PWM comparator. The latch is set and the power transistor conduction is terminated when the modulating ramp intersects with the error amplifier output (COMP).

The current-mode switching regulator is a dual-loop feedback control system. In the inner current loop, the EA output (COMP) controls the peak inductor current. In the outer loop, the error amplifier regulates the output voltage to keep the LED current at setting point. The double reactive poles of the output LC filter are reduced to a single real pole by the inner current loop, allowing the simple loop compensation network to accommodate a wide range of input and output voltages.

It is well known that, in Boost converter, V_o is greater than or equal to V_{in} . In normal continuous conduction mode (CCM) operation,

$$\frac{V_o}{V_{in}} = \frac{1}{1-D}$$

Where, D is the duty ratio of the PWM power switch. As V_{in} increases, in order to regulate V_o to a given constant value, D decreases. When V_{in} approaches V_o , D surely leads to 0. In practice, due to the minimum on-time of the PWM power switch, D usually could not approach 0 with infinitely small granularity. At some point, it either produces one pulse with minimum on-time or generates 0 by skipping the pulse. Such point could be theoretically calculated for SC441D as follows.

For CCM: $V_{in} \geq 0.92 V_o$.

For DCM (Discontinuous conduction mode):

$$V_{in} \geq \frac{2}{1 + \sqrt{1 + 1.6 \cdot 10^{-2} \cdot \frac{R_o}{L}}} V_o$$

Where, R_o is the Boost equivalent output resistance ($=V_o/I_o$), L is the Boost inductor (in uH).

In many Boost converter designs and operations, pulse skipping is normally allowed at light load conditions. Some designers even purposely let the Boost power converter enter the pulse skipping in order to save power at light load conditions. If some designers do not want pulse skipping mode, based on the conditions provided above,

there are some choices.

- 1) Leave some room between V_{in} range and V_o .
- 2) Operate the Boost converter at normal load (less R_o)
- 3) Increases the Boost inductance (L).

Over-Current Protection

SC441D provides cycle-by-cycle current limiting for its internal switch. If the switch current exceeds 4.1A (the typical current-limit trip point), then the current-limit comparator ILIM, will set the latch immediately turning off internal power. All LED current sources keep operating in an over-current condition. Due to separate pulse-width modulating and current limiting paths, the OCP trip point is not affected by slope compensation (i.e. trip point is not affected by switching duty cycle).

Over-Voltage Protection (OVP)

SC441D includes an external programming over-voltage protection circuit to prevent damage to the IC and output capacitor in the event of an open-circuit condition. The boost converter's output voltage is detected at the OV PIN pin. If the voltage at the OV PIN pin exceeds 1.52V (typical), the boost converter will shut down and a 0.9mA pull-down current will be applied to the VOUT pin to quickly discharge the output capacitor. This added protection prevents a condition where the output capacitor and Schottky diode must endure high voltage for an extended time, which can pose a reliability risk for the user's system.

Refer to evaluation application circuit in page18. The output over voltage trip point can be programmed by R5 and R7 resistor divider.

The relationship can be described as follows:

$$OVP_trip = OV PIN_TH \times \frac{R_5 + R_7}{R_7}$$

Where OV PIN_TH is 1.52V typical.

An OVP event causing a fault could disable the boost converter enabling the device to a strong pull-down. This event would cause the FFLAG pin to go high and the soft-start capacitor to discharge. When the soft-start capacitor voltage falls below 0.5V, and the output voltage falls to V_{in} , SC441D enters a soft-start process.

The OVP detection circuitry provides a disconnect function during the shutdown state to prevent any leakage from the output. The external OVP resistor divider should be connected between VOUT and OV PRTN with the central

Applications Information (continued)

tap connected to OVPIN.

Note: If this disconnect function is not desired, bypass the OVPRTN pin and connect the end of the OVP resistor divider directly to GND. The OVPIN pin is sensitive to noise, and a proper decoupling capacitor (1nF ~ 10nF) is required. The combined impedance of the resistor divider for OVPIN should be greater than 200kΩ.

LED Short-Circuit Protection

If one or more LEDs are detected as shortened, that corresponding string will be latched off if SCP_EN is floating. The voltages on all internal LED current sources (IO pins) are monitored to see if any exceeds the setting voltage (The IO voltage on abnormal LED string will rise earlier than other floating LED strings). If any IO pin voltage exceeds the setting voltage, that IO current source will be latched off. The latch can be reset if VIN falls below UVLO or recycle EN signal. Other normal LED strings remain at their normal operation. The protection will be disabled if SCP_EN is tied to GND. If all IO pin voltages reach 0.8V then the internal main switch will be off until any of the IO voltages is lower than 0.7V.

The setting voltage for SCP can be programmed by R33 (see the schematic on page 18). The relationship can be described as follows:

$$V_{SCP}(V) = 0.051 \times R_{33}(K\Omega)$$

Where VSCP is the SCP setting voltage in Volt and R₃₃ is in kohm.

Unused Strings

The SC441D may be operated with less than 4 strings. In this case, all unused strings should be tied to VIN and leave the SCP_EN pin floating.

LED Open-Circuit Protection

If any LED string is detected as an open-circuit, that string will latch off. If any given string is open, the IO current source will go to deep saturation; the COMP and FFLAG pins will be driven high and the boost converter duty cycle will increase causing VOUT to rise. At some point VOUT will rise high enough to cause all the IO pin voltages of the intact strings to reach the shorted LED detection level and latch off those strings. Because of the LED open string VOUT will continue to rise until it reaches the programmed OVP level.

When OVP is reached, the voltage on the IO pins are monitored and if any IO voltage is less than 0.2V that string will be identified as open and will latch off.

Only when VIN falls below UVLO, or an EN signal is recycled, and if thermal shutdown occurs, can this latch be reset. A hiccup cycle is then initiated and the SS pin is discharged slowly with a 1μA current source and a 0.9mA discharge path (turned on to pull down VOUT). When SS falls below 0.5V and VOUT falls below to VIN, the shorted LED detection latches are reset and a new soft-start sequence is initiated to resume normal operation.

Thermal Shutdown (TSD)

If the thermal shutdown temperature of 150°C is reached, a hiccup sequence is initiated where the boost converter and all IO current sources are turned off. SS is discharged by a 1μA current source, and a 0.9mA discharge path is turned on to pull down VOUT. As temperature falls below the TSD trip point, SC441D will retry when SS falls below 0.5V and VOUT falls to VIN.

PWM Dimming

The PWM input needs to be held high for normal operation. PWM dimming can be done by cycling the PWM input at a given frequency where a “low” on the PWM input turns off all IO current sources and a “high” turns on all IO current sources. The short and open detection latches are blanked for approximately 2μs as the PWM input transitions from low-to-high to prevent a false fault detection during PWM dimming.

The PWM pin can be toggled by external circuitry to allow PWM dimming. In a typical application, a microcontroller sets a register – or counter, that varies the pulse-width on a GPIO pin. The SC441D allows dimming over two decades in frequency (50Hz–50kHz), in order to allow compatibility with a wide range of devices, including the newest dimming strategies that avoid the audio band by using high frequency PWM dimming. In this manner, a wide range of illumination can be generated while keeping the instantaneous LED current at its peak value for luminescent efficiency and color purity. Furthermore, advanced lighting effects such as backlight dim-on can be implemented as the SC441D can resolve 10μs (minimum), PWM dimming pulse-width.

As far as the maximum PWM dimming pulse-width, it

Applications Information (continued)

depends on the PWM dimming frequency. Clearly, it is trivial to get 100% LED brightness by pulling PWM pin “High” constantly. When the user tries to dim the LED brightness using PWM signal from 100% down, he or she needs to observe the following. When the PWM dimming signal is actively switching from “High” to “Low” and to “High”, there is a minimal OFF time (T_{off_min} , 200ns, guaranteed by design) requirement of the PWM dimming signal with this IC. Such minimal OFF time sets the maximum PWM duty ratio before hitting to 100% in the following way.

$$D_{max} = 1 - \frac{T_{off_min}}{f_{PWM}}$$

For example, if the PWM dimming frequency $f_{PWM}=200\text{Hz}$, the $D_{max}=99.99\%$. If $f_{PWM}=25\text{kHz}$, the $D_{max}=99.5\%$. With most practical dimming interfaces, the needed dimming steps and resolutions, it is uncommon to run into the above D_{max} before reaching 100%. While most applications will not run into D_{max} , the designer should be aware of possible parasitic elements from PWM dimming interface to the PWM pin of SC441D. Usually, simply checking signal D_{max} at PWM pin of SC441D is sufficient.

Linear Dimming

The linear dimming control is available for SC441D by applying an external control voltage on IOSET pin through an external resistor-like circuit (shown below). External environment brightness compensation can also be achieved when the control voltage is generated by a light sensor circuit.

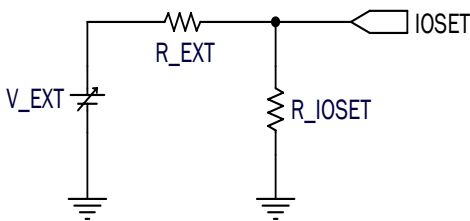

The IOSET voltage is 0.5V when linear dimming is used and the minimum IOSET current must be higher than $27\mu\text{A}$ (i.e. 15mA per LED string). The external control voltage slew rate must slow at 1V/10ms.

LED Strings Connection

Generally, LED strings are connected to IO1 ~ IO4 pins through a mechanical connector which, generally, cannot support an electrical connection thereby resulting in significant noise. Consequently, the SC441D LED short-

circuit protection may false trip when the noise level is large. Certain ceramic decoupling capacitor on pins IO1 ~ IO4 to GND are useful to prevent the SC441D from noise influence.

As a general guideline, the decoupling capacitance should be limited as follows.

$$C_{dcple} < I_{LED} * \frac{0.6\mu\text{S}}{V_o}$$

Where, I_{LED} is the LED current per string, V_o is the Boost output voltage and C_{dcple} is the suggested decoupling capacitor value.

For example, if $I_{LED}=10\text{mA}$, $V_o=13.5\text{V}$, the calculated upper bound of C_{dcple} is about 444pF. One could use 390pF or less in the circuit. If $I_{LED}=100\text{mA}$, $V_o=13.5\text{V}$, the calculated upper bound of C_{dcple} is about 4.44nF. One may use 3.9nF or less in the circuit. In some applications, circuit designers tend to select the decoupling capacitors in the range of (100pF ~ 1nF). For some low LED current (e.g. 10mA) applications, it is recommended to add 1M-10Mohm resistor from IO pin to GND in order to reduce IO pin voltage during PWM dimming.

Parallel Operation

When two or more SC441Ds are operating in parallel for a large-sized panel application, audible noise may be observed due to non-synchronous switching frequency. The ripple voltage on the input voltage rail will be modulated by the beat frequency resulting in audible noise. This situation can be resolved by adding an input inductor between input voltage rail and the SC441D VIN pin. This situation can also be improved by adding more input decoupling capacitors.

Inductor Selection

The inductance value of the inductor affects the converter’s steady state operation, transient response, and its loop stability. Special attention needs to be paid to three specifications of the inductor, its value, its DC resistance and saturation current. The inductor’s inductance value also determines the inductor ripple current. The converter can operate in either CCM or DCM depending on its working conditions. The inductor DC current or input current can be calculated as,

Applications Information (continued)

$$I_{IN} = \frac{V_{OUT} \cdot I_{OUT}}{V_{IN} \cdot \eta}$$

I_{IN} - Input current;

I_{OUT} - Output current;

V_{OUT} - Boost output voltage;

V_{IN} - Input voltage;

η - Efficiency of the boost converter.

Then the duty ratio is,

$$D = \frac{V_{OUT} - V_{IN} + V_D}{V_{OUT} + V_D}$$

V_D - Forward conduction drop of the output rectifying diode

When the boost converter runs in DCM ($L < L_{boundary}$), it takes the advantages of small inductance and quick transient response while avoiding the bandwidth limiting instability of the RHP zero found in CCM boost converters.

The inductor peak current is,

$$I_{L-peak} = \frac{V_{IN} \cdot D}{F_S \cdot L}$$

The converter will work in CCM if $L > L_{boundary}$. Generally the converter has higher efficiency under CCM and the inductor peak current is,

$$I_{L-peak} = I_{IN} + \frac{V_{IN} \cdot D}{2 \cdot F_S \cdot L}$$

For many applications, an inductor with value of 4.7μH to 22μH should be fine, such as for the typical case shown on page 1. The inductor peak current must be less than its saturation rating. When the inductor current is close to the saturation level, its inductance can decrease 20% to 35% from the 0A value depending on the vendor specifications. Using a small value inductor forces the converter under DCM in which case the inductor current ramps down to zero before the end of each switching cycle. It reduces the boost converter's maximum output current, and produces large input voltage ripple. An inductor with larger inductance will reduce the bandwidth of the feedback loop, possibly higher DC resistance (DCR). Inductor's DCR plays a significant role for the total efficiency since the power transistor is integrated inside the SC441D. Of course, there is a trade-off between the DCR and inductor

size. Table 2 lists recommended inductors and their vendors.

Table 2. Recommended Inductors

Inductor	Website
DR74, 4.7μH ~ 15μH	www.cooperet.com
IHLP-2525CZ-01, 4.7μ ~ 10μH	www.vishay.com
DS85LC, 6.8μH ~ 10μH	www.tokoam.com

Output Capacitor Selection

The next task in SC441D design is targeting the proper amount of ripple voltage due to the constant-current LED loads. The two error amplifiers that control the PWM converter sense the delta between requested current and actual current in each output current regulator. On a cycle-by-cycle basis, a small amount of output ripple ensures good sensing and tight regulation, while the output current regulators keep each LED current at a fixed value. Overall, this allows usage of small output caps while ensuring precision LED current regulation. Although the mechanics of regulation and frequency dependence may be complex, actual selection of output capacitor can be simplified because this capacitor is mainly selected for the output ripple of the converter. Assume a ceramic capacitor is used. The minimum capacitance needed for a given ripple can be estimated by,

$$C_{OUT} = \frac{(V_{OUT} - V_{IN}) \cdot I_{OUT}}{V_{OUT} \cdot F_S \cdot V_{RIPPLE}}$$

V_{RIPPLE} - Peak to peak output ripple;

I_{OUT} - Output current;

V_{OUT} - Boost output voltage;

V_{IN} - Input voltage;

F_S - Switching frequency.

During load transient, the output capacitor supplies or absorbs additional current before the inductor current reaches its steady state value. Larger capacitance helps with the overshoot and undershoots during load transient, and loop stability. Recommended ceramic capacitor manufacturers are listed in Table 3.

Applications Information (continued)

Table 3. Recommended Ceramic Capacitor Manufacturers

through R14 for better noise immunity.

Vendor	Phone	Website
Kemet	408-986-0424	www.kemet.com
Murata	814-237-1431	www.murata.com
Taiyo Yuden	408-573-4150	www.t-yuden.com

Output Rectifying Diode Selection

Schottky diodes are the ideal choice for SC441D due to their low forward voltage drop and fast switching speed. Table 4 shows several different Schottky diodes that work well with the SC441D. Make sure that the diode has a voltage rating greater than the possible maximum output voltage. The diode conducts current only when the power switch is turned off. A diode of 2A will be sufficient for most designs.

Table 4. Recommended Rectifying Diodes

Part	Vendor
SS23	Vishay
SS24	www.vishay.com

Layout Guidelines

The SC441D contains a boost converter and the placements of the power components outside the SC441D should follow the layout guidelines of a general boost converter. The evaluation application circuit on page 18 will be used as an example. C2 and C3 are input decoupling capacitors for SC441D VIN pin and main power input. C2, C3 should be placed as close as possible to the VIN pin to achieve the best decoupling performance.

To minimize the switching noise, the switching loop formed by input decoupling capacitors, internal switch, output Schottky diode and output capacitors must be minimized. The LED current programming resistor (R6), compensation network (R9, C5, C7) and soft start capacitor (C6) should be placed as close as possible to SC441D. The C14~C17 are decoupling capacitors for LED current source which prevent IO pins from noise influence. C14~C17 should be placed close to each corresponding IO pin.

Use an isolated local AGND plane underneath the controller and tie it to the negative side of output capacitor

Evaluation Application Circuit

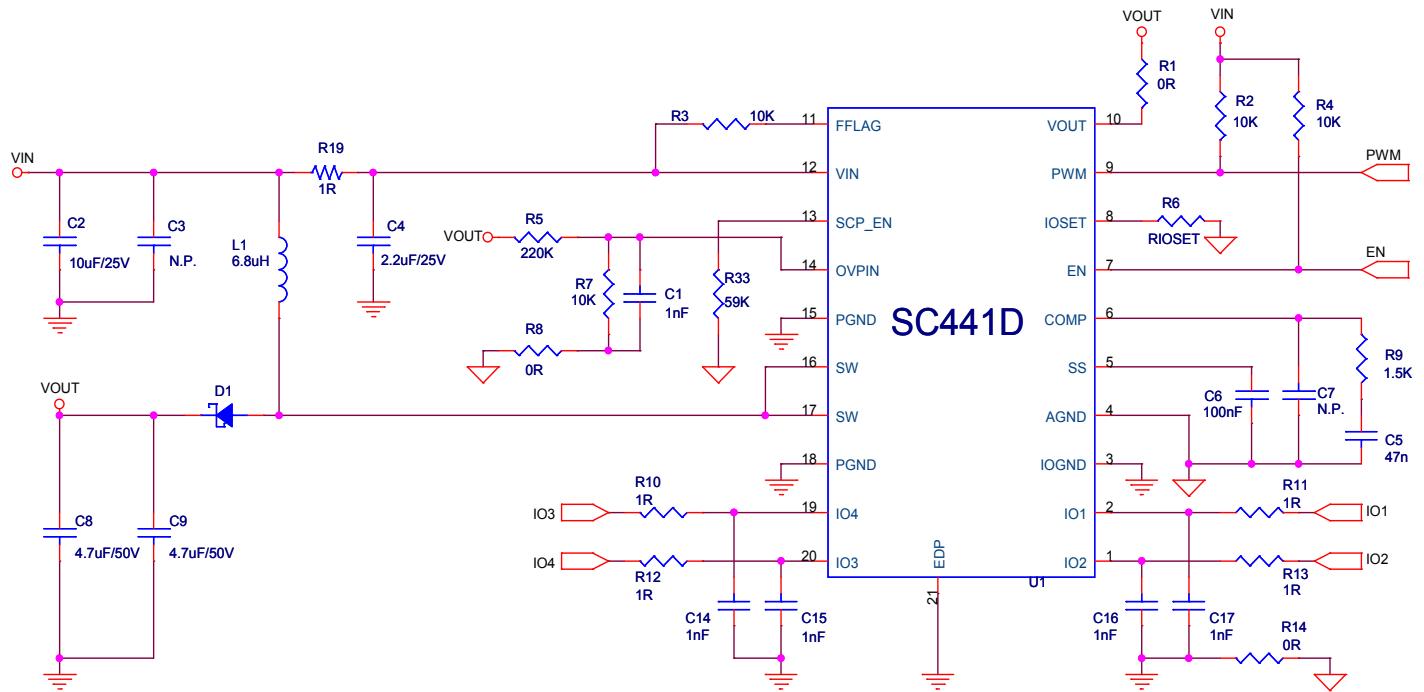

Evaluation Board Bill of Materials

Item	Reference	Quantity	Description	Package	Part	Vendor
1	C1, C14, C15, C16, C17	5	50V ceramic capacitor, X7R	SM_0603	1nF	Panasonic
2	C2	1	25V ceramic capacitor, X5R	SM_1206	10uF	Panasonic
3	C8, C9	2	50V ceramic capacitor, X5R	SM_1206	4.7uF	Panasonic
4	C4	1	25V ceramic capacitor, X5R	SM_0805	2.2uF	Panasonic
5	C5	1	6.3V ceramic capacitor, X7R	SM_0603	47nF	Panasonic
6	C6	1	6.3V ceramic capacitor, X7R	SM_0603	100nF	Panasonic
7	D1	1	60V, 2A Schottky diode	SMA	B260	Diodes or Any
8	L1	1	6.8μH, 3.67A	DR74	6.8μH	Copper or Any
9	R1, R8, R14	3	1% SMD resistor	SM_0603	0R	Any
10	R2, R3, R4, R7	4	5% SMD resistor	SM_0603	10K	Any
11	R5	1	1% SMD resistor	SM_0603	220K	Any
12	R6	1	1% SMD resistor	SM_0603	RIOSET	Any
13	R9	1	5% SMD resistor	SM_0603	1.5K	Any
14	R19, R10, R11, R12, R13	5	5% SMD resistor	SM_0603	1R	Any
16	R33	1	5% SMD resistor	SM_0603	59K	Any
15	U1	1	Controller	EDPTSSOP-20	SC441D	SEMTECH

Outline Drawing - TSSOP-20 EDP

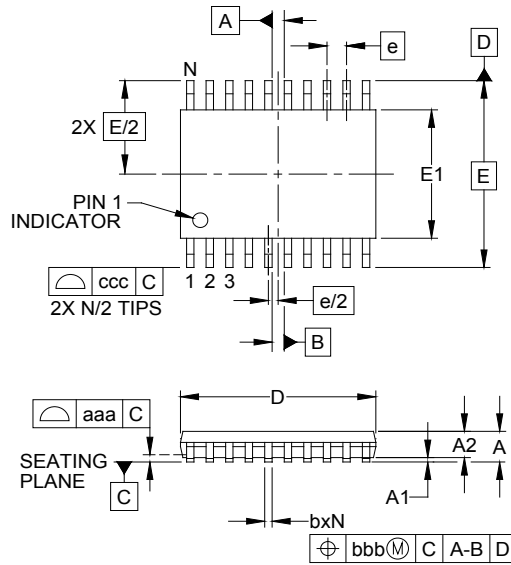

DIM	INCHES			MILLIMETERS		
	MIN	NOM	MAX	MIN	NOM	MAX
A	-	-	.047	-	-	1.20
A1	.001	-	.006	0.025	-	0.15
A2	.031	-	.042	0.80	-	1.05
b	.007	-	.012	0.19	-	0.30
c	.003	-	.007	0.09	-	0.20
D	.251	.255	.259	6.40	6.50	6.60
E1	.169	.173	.177	4.30	4.40	4.50
E	.252 BSC			6.40 BSC		
e	.026 BSC			0.65 BSC		
F	.144	.150	.154	3.66	3.81	3.91
H	.112	.118	.122	2.85	3.00	3.10
L	.018	.024	.030	0.45	0.60	0.75
L1	(.039)			(1.0)		
N	20			20		
θ1	0°	-	8°	0°	-	8°
aaa	.004			0.10		
bbb	.004			0.10		
ccc	.008			0.20		

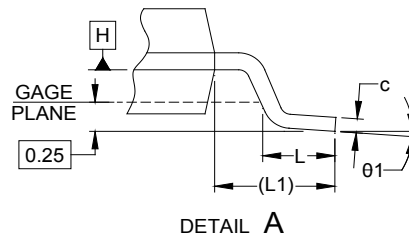
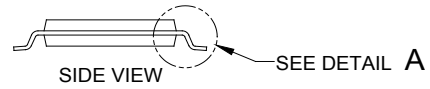
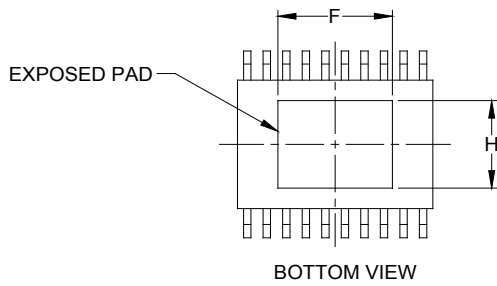

NOTES:

1. CONTROLLING DIMENSIONS ARE IN MILLIMETERS (ANGLES IN DEGREES).
2. DATUMS **-A-** AND **-B-** TO BE DETERMINED AT DATUM PLANE **-H-**
3. DIMENSIONS "E1" AND "D" DO NOT INCLUDE MOLD FLASH, PROTRUSIONS OR GATE BURRS.

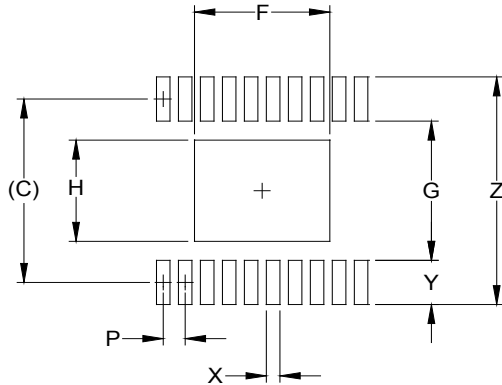
Land Pattern -TSSOP-20 EDP

DIMENSIONS		
DIM	INCHES	MILLIMETERS
C	(.222)	(5.65)
F	.157	4.00
G	.161	4.10
H	.126	3.20
P	.026	0.65
X	.016	0.40
Y	.061	1.55
Z	.283	7.20

NOTES:

1. CONTROLLING DIMENSIONS ARE IN MILLIMETERS (ANGLES IN DEGREES).
2. THIS LAND PATTERN IS FOR REFERENCE PURPOSES ONLY. CONSULT YOUR MANUFACTURING GROUP TO ENSURE YOUR COMPANY'S MANUFACTURING GUIDELINES ARE MET.
3. THERMAL VIAS IN THE LAND PATTERN OF THE EXPOSED PAD SHALL BE CONNECTED TO A SYSTEM GROUND PLANE. FAILURE TO DO SO MAY COMPROMISE THE THERMAL AND/OR FUNCTIONAL PERFORMANCE OF THE DEVICE.

Contact Information

Semtech Corporation
 Power Management Products Division
 200 Flynn Road, Camarillo, CA 93012
 Phone: (805) 498-2111 Fax: (805) 498-3804

www.semtech.com

© Semtech 2012

All rights reserved. Reproduction in whole or in part is prohibited without the prior written consent of the copyright owner. The information presented in this document does not form part of any quotation or contract, is believed to be accurate and reliable and may be changed without notice. No liability will be accepted by the publisher for any consequence of its use. Publication thereof does not convey nor imply any license under patent or other industrial or intellectual property rights. Semtech assumes no responsibility or liability whatsoever for any failure or unexpected operation resulting from misuse, neglect improper installation, repair or improper handling or unusual physical or electrical stress including, but not limited to, exposure to parameters beyond the specified maximum ratings or operation outside the specified range.

SEMTECH PRODUCTS ARE NOT DESIGNED, INTENDED, AUTHORIZED OR WARRANTED TO BE SUITABLE FOR USE IN LIFE-SUPPORT APPLICATIONS, DEVICES OR SYSTEMS OR OTHER CRITICAL APPLICATIONS. INCLUSION OF SEMTECH PRODUCTS IN SUCH APPLICATIONS IS UNDERSTOOD TO BE UNDERTAKEN SOLELY AT THE CUSTOMER'S OWN RISK. Should a customer purchase or use Semtech products for any such unauthorized application, the customer shall indemnify and hold Semtech and its officers, employees, subsidiaries, affiliates, and distributors harmless against all claims, costs damages and attorney fees which could arise.

Notice: All referenced brands, product names, service names and trademarks are the property of their respective owners.