

DESCRIPTION

The SE/NE5534 is a high-performance low noise operational amplifier. Compared to most of the standard operational amplifiers, such as 741 and 301A, it shows better noise performance, improved output drive capability and considerably higher small-signal and power bandwidths.

This makes the device especially suitable for application in high quality and professional audio equipment, in instrumentation and control circuits and telephone channel amplifiers. The op amp is internally compensated for gain equal to, or higher than, three. The frequency response can be optimized with an external compensation capacitor for various applications (unity gain amplifier, capacitive load, slew-rate, low overshoot, etc.) If very low noise is of prime importance, it is recommended that the SE/NE5534A version be used which has guaranteed noise specifications.

PIN CONFIGURATIONS

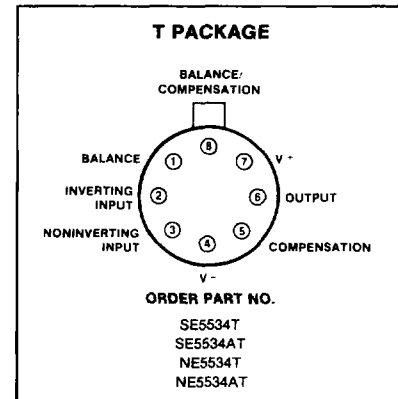
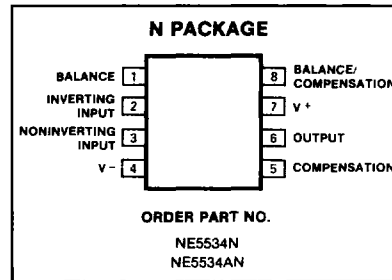

FEATURES

- Small-signal bandwidth: 10MHz
- Output drive capability: 600Ω, 10V (rms) at $V_s = \pm 18V$
- Input noise voltage: $4nV/\sqrt{Hz}$
- DC voltage gain: 100000
- AC voltage gain: 6000 at 10kHz
- Power bandwidth: 200kHz
- Slew-rate: $13V/\mu s$
- Large supply voltage range: ± 3 to $\pm 20V$

EQUIVALENT SCHEMATIC

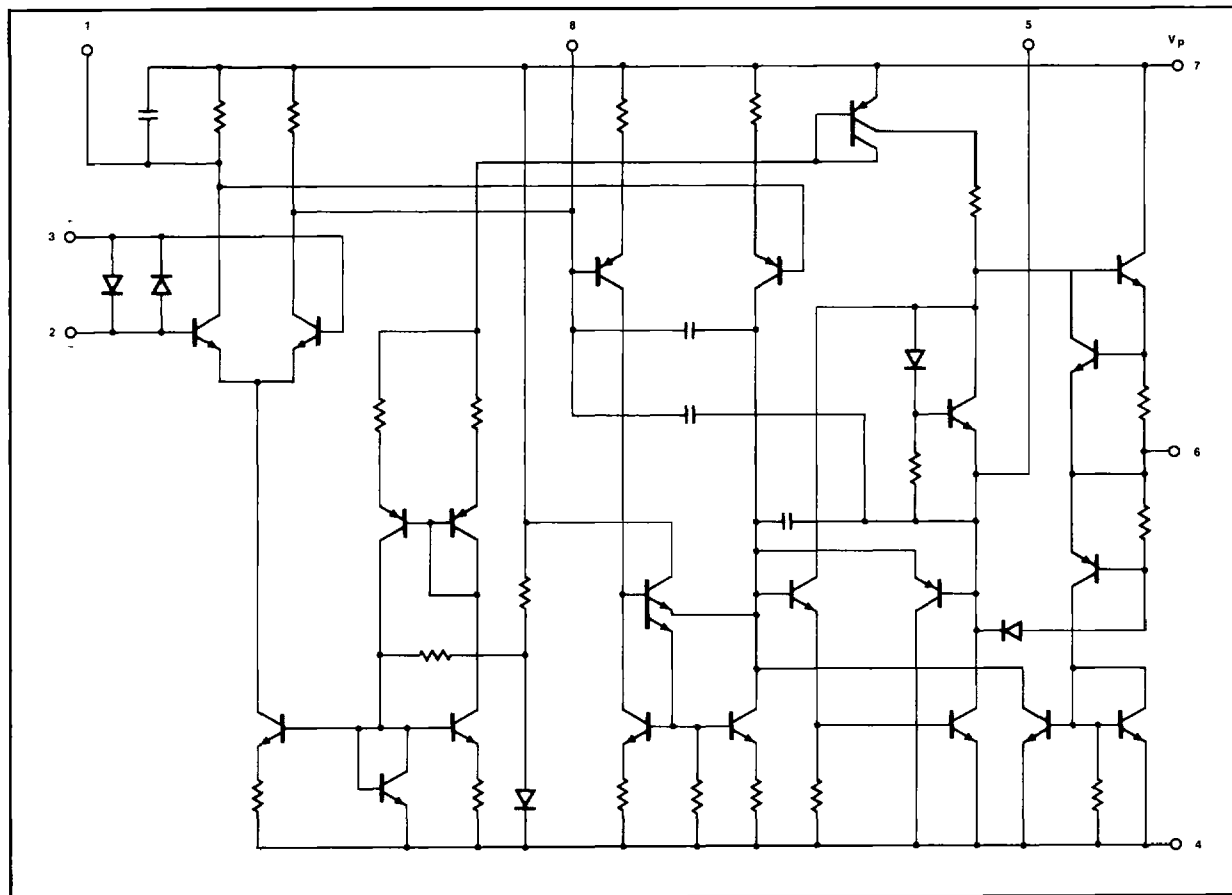

ABSOLUTE MAXIMUM RATINGS

PARAMETER	RATING	UNIT
V _S Supply voltage	±22	V
V _{IN} Input voltage	±V supply	V
V _{DIFF} Differential input voltage	±.5	V
T _A Operating temperature range ¹		
SE	-55 to +125	°C
NE	0 to 70	°C
T _{STG} Storage temperature	-65 to +150	°C
T _J Junction temperature	150	°C
P _D Power dissipation		
5534T	680	mW
5534N	500	mW
Output short circuit duration ²	indefinite	
Lead temperature (soldering 10 sec) ³	300	°C

NOTES

- Diodes protect the inputs against over-voltage. Therefore, unless current-limiting resistors are used, large currents will flow if the differential input voltage exceeds 0.6V. Maximum current should be limited to ±10mA.
- For operation at elevated temperature T package must be derated based on a thermal resistance of 150°C/W junction to ambient, 45°C/W junction to case. Thermal resistance of the N package is 240°C/W.
- Output may be shorted to ground at V_S = ±15V, T_A = 25°C. Temperature and/or supply voltages must be limited to ensure dissipation rating is not exceeded

DC ELECTRICAL CHARACTERISTICS T_A = 25°C, V_S = ±15V unless otherwise specified.^{1,2}

PARAMETER	TEST CONDITIONS	SE5534/5534A			NE5534/5534A			UNIT
		Min	Typ	Max	Min	Typ	Max	
V _{OS} Offset voltage	Over temperature		.5	2 3		.5	4 5	mV mV
I _{OS} Offset current	Over temperature		10	200 500		20	300 400	nA nA
I _B Input current	Over temperature		400	800 1500		500	1500 2000	nA nA
I _{CC} Supply current	Over temperature		4	6.5 9		4	8	mA mA
V _{CM} Common mode input range		±12	±13		±12	±13		V
CMRR Common mode rejection ratio		80	100		70	100		dB
PSRR Power supply rejection ratio			10	50		10	100	μV/V
A _{VOL} Large signal voltage gain	R _L ≥ 600Ω, V _O = ±10V Over temperature	50 25	100		25 15	100		V/mV V/mV
V _{OUT} Output swing	R _L ≥ 600Ω R _L ≥ 600Ω V _S = ±18V	±12 ±15	±13 ±16		±12 ±15	±13 ±16		V V
R _{IN} Input resistance		50	100		30	100		KΩ
I _{SC} Output short circuit current			38			38		mA

NOTES

- For NE5534, NE5534A, T_{MIN} = 0°C, T_{MAX} = 70°C
- For SE5534, SE5534A, T_{MIN} = -55°C, T_{MAX} = +125°C

AC ELECTRICAL CHARACTERISTICS $T_A = 25^\circ\text{C}$, $V_S = \pm 15\text{V}$ unless otherwise specified.

PARAMETER	TEST CONDITIONS	SE5534/5534A			NE5534/5534A			UNIT
		Min	Typ	Max	Min	Typ	Max	
R _{OUT} Output resistance	$A_V = 30\text{dB}$ closed loop $f = 10\text{kHz}$, $R_L = 600\Omega$, $C_C = 22\text{pF}$		0.3			0.3		Ω
Transient response	Voltage follower, $V_{IN} = 50\text{mV}$ $R_L = 600\Omega$, $C_C = 22\text{pF}$, $C_L = 100\text{pF}$							
T _R Rise time			20			20		ns
Overshoot			20			20		%
Transient response	$V_{IN} = 50\text{mV}$, $R_L = 600\Omega$ $C_C = 47\text{pF}$, $C_L = 500\text{pF}$							
T _R Rise time			50			50		ns
Overshoot			35			35		%
AC Gain	$f = 10\text{kHz}$, $C_C = 0$ $f = 10\text{kHz}$, $C_C = 22\text{pF}$		6			6		V/mV
Gain bandwidth product	$C_C = 22\text{pF}$, $C_L = 100\text{pF}$		2.2			2.2		V/mV
Slew rate	$C_C = 0$ $C_C = 22\text{pF}$		10			10		mHz
Power bandwidth	$V_{OUT} = \pm 10\text{V}$, $C_C = 0$ $V_{OUT} = \pm 10\text{V}$, $C_C = 22\text{pF}$ $V_{OUT} = \pm 14\text{V}$, $R_L = 600\Omega$ $C_C = 22\text{pF}$, $V_{CC} = \pm 18\text{V}$		13			13		V/ μS
			6			6		V/ μS
			200			200		kHz
			95			95		kHz
			70			70		kHz

ELECTRICAL CHARACTERISTICS $T_A = 25^\circ\text{C}$, $V_S = \pm 15\text{V}$ unless otherwise specified.

PARAMETER	TEST CONDITIONS	SE5534/NE5534			SE5534A/NE5534A			UNIT
		Min	Typ	Max	Min	Typ	Max	
Input noise voltage	$f_o = 30\text{Hz}$ $f_o = 1\text{kHz}$		7			5.5	7	nV/ $\sqrt{\text{Hz}}$
Input noise current	$f_o = 30\text{Hz}$ $f_o = 1\text{kHz}$		4			3.5	4.5	nV/ $\sqrt{\text{Hz}}$
Broadband noise figure	$f = 10\text{Hz} - 20\text{kHz}$, $R_S = 5\text{k}\Omega$		2.5			1.5		pA/ $\sqrt{\text{Hz}}$
			0.6			0.4		pA/ $\sqrt{\text{Hz}}$
			-			0.9		dB

TYPICAL PERFORMANCE CHARACTERISTICS

OPEN LOOP FREQUENCY RESPONSE

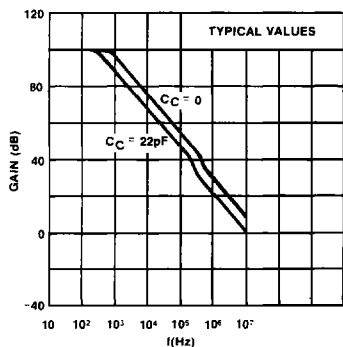

SLEW-RATE AS A FUNCTION OF COMPENSATION CAPACITANCE

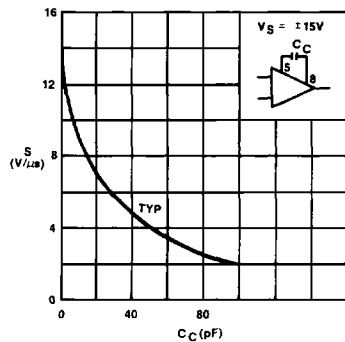

CLOSED LOOP FREQUENCY RESPONSE

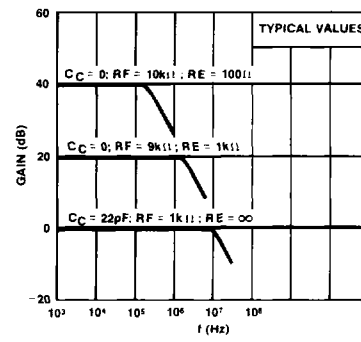

LARGE-SIGNAL FREQUENCY RESPONSE

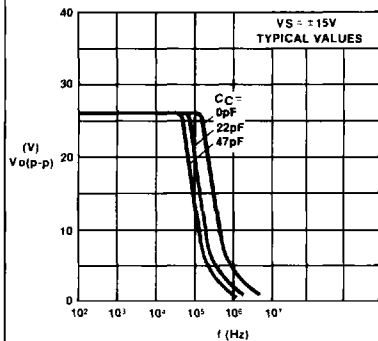

OUTPUT SHORT-CIRCUIT CURRENT

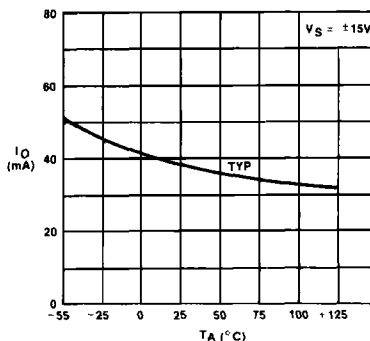

INPUT BIAS CURRENT

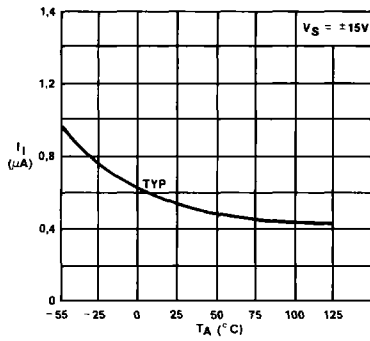

INPUT COMMON MODE VOLTAGE RANGE

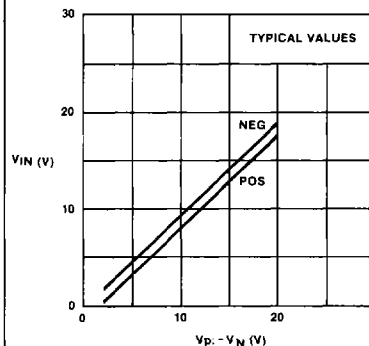

SUPPLY CURRENT

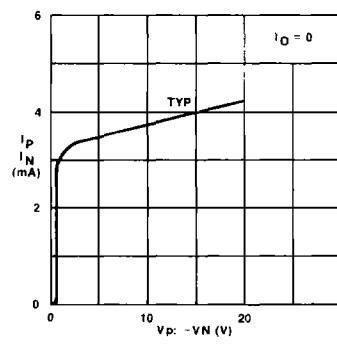

INPUT NOISE VOLTAGE DENSITY

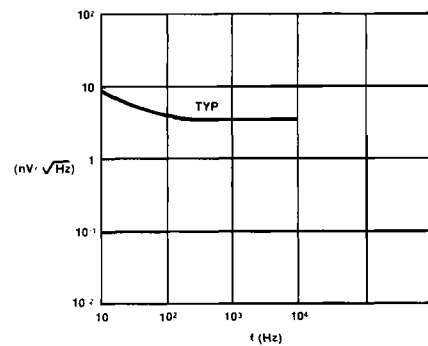

TYPICAL PERFORMANCE CHARACTERISTICS (Cont'd)

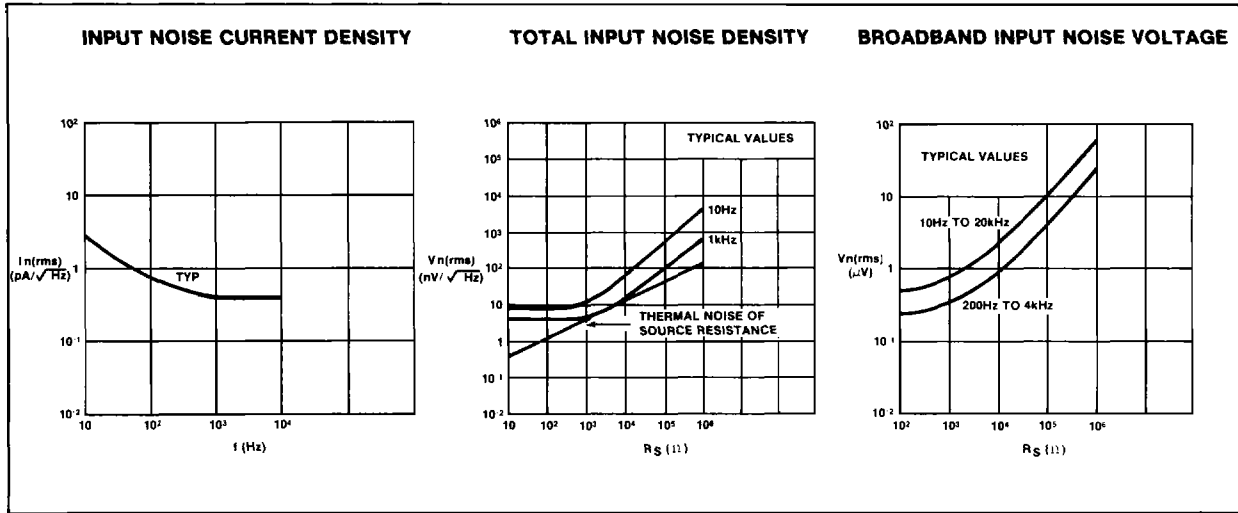

TEST LOAD CIRCUITS

