

### FEATURES

- **LOW POWER CONSUMPTION:**  
15 mW ( $V_{CC} = 3.4$  V,  $I_{CC} = 4.5$  mA)
- **HIGH POWER GAIN:** 20 dB (UPC2715T)
- **WIDE FREQUENCY RESPONSE:**  
2 GHz (UPC2714T)
- **INTERNAL CURRENT REGULATION MINIMIZES GAIN CHANGE OVER TEMPERATURE**
- **SUPER SMALL PACKAGE**
- **TAPE AND REEL PACKAGING OPTION AVAILABLE**

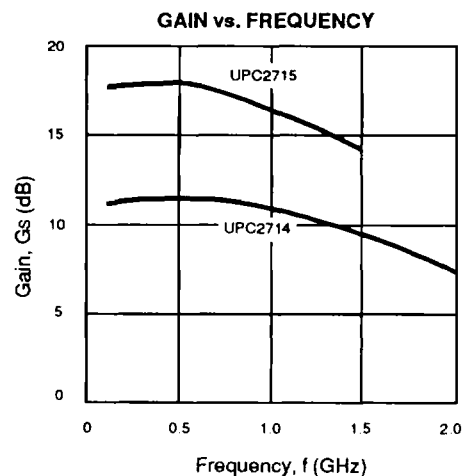

### DESCRIPTION

The UPC2714T and UPC2715T are Silicon Monolithic integrated circuits manufactured using the NESAT III process. These devices are suitable for applications which require low power consumption and wide frequency operation. They are designed for low cost, low power consumption gain stages in cellular radios, GPS receivers, and PCN applications.

NEC's stringent quality assurance and test procedures ensure the highest reliability and performance.

### ELECTRICAL CHARACTERISTICS ( $T_A = 25^\circ\text{C}$ , $f = 0.5$ GHz, $V_{CC} = 3.4$ V)

PART NUMBER PACKAGE OUTLINE			UPC2714T T06			UPC2715T T06		
SYMBOLS	PARAMETERS AND CONDITIONS	UNITS	MIN	TYP	MAX	MIN	TYP	MAX
$I_{CC}$	Circuit Current	mA	3.3	4.5	5.7	3.3	4.5	5.7
$G_S$	Small Signal Gain	dB	8.5	11.5	15.5	16	19	23
$f_u$	Upper Limit Operating Frequency (The gain at $f_u$ is 3 dB down from the gain at 0.1 GHz)	GHz	1.4	1.8		0.9	1.2	
$\Delta G_S$	Gain Flatness, $f = 0.1 \sim 0.6$ GHz	dB		$\pm 1.0$			$\pm 1.0$	
$P_{SAT}$	Saturated Output Power	dBm	-10	-7		-9	-6	
NF	Noise Figure	dB		5.0	6.5		4.5	6.0
$RL_{IN}$	Input Return Loss	dB	10	13		12	17	
$RL_{OUT}$	Output Return Loss	dB	5	8		5	8	
ISOL	Isolation	dB	22	27		28	33	
$\Delta GT$	Gain-Temperature Coefficient	dB/ $^\circ\text{C}$		+0.006			+0.006	
$R_{TH}$	Thermal Resistance (Junction to Ambient)	$^\circ\text{C}/\text{W}$			200			200

**ABSOLUTE MAXIMUM RATINGS<sup>1</sup>** (T<sub>A</sub> = 25°C)

SYMBOLS	PARAMETERS	UNITS	RATINGS
V <sub>CC</sub>	Supply Voltage	V	4.0
P <sub>IN</sub>	Input Power	dBm	-5
P <sub>T</sub>	Total Power Dissipation <sup>2</sup>	mW	200
T <sub>OP</sub>	Operating Temperature	°C	-40 to +85
T <sub>STG</sub>	Storage Temperature	°C	-55 to +150

Notes:

1. Operation in excess of any one of these parameters may result in permanent damage.
2. Mounted on 50 x 50 x 1.6 mm epoxy glass PWB (T<sub>A</sub> = 85°C).

**RECOMMENDED OPERATING CONDITIONS**

SYMBOL	PARAMETER	UNITS	MIN	TYP	MAX
V <sub>CC</sub>	Supply Voltage	V	3.06	3.4	3.74

**TYPICAL PERFORMANCE CURVES** (T<sub>A</sub> = 25°C)

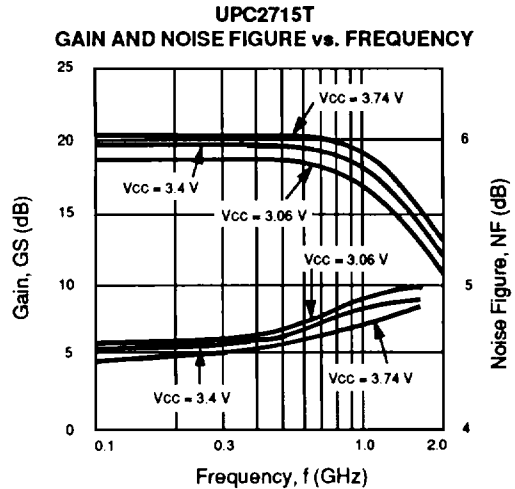
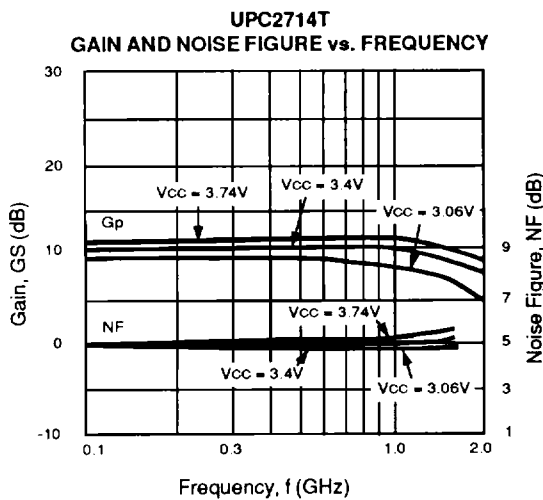
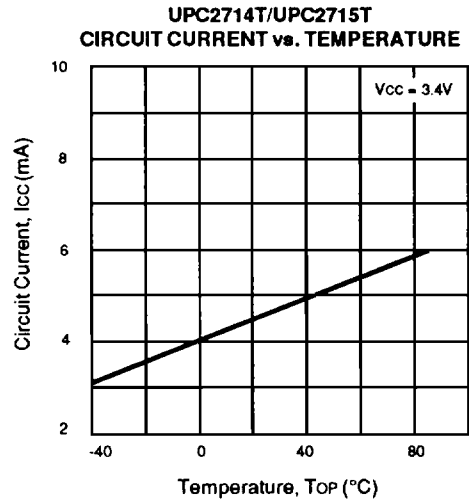
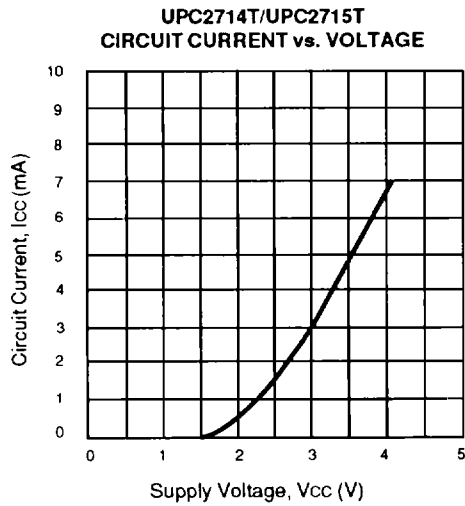

TYPICAL PERFORMANCE CURVES (TA = 25°C, VCC = 3.4 V)

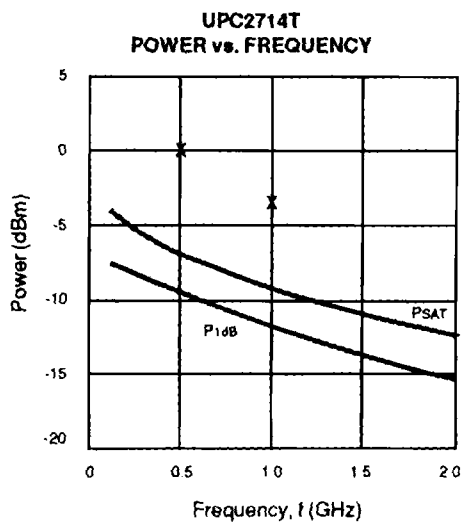
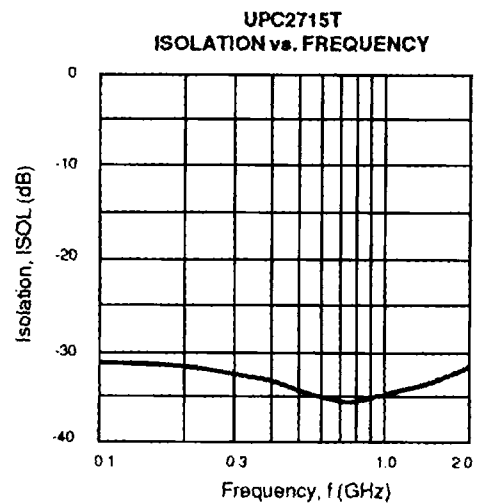
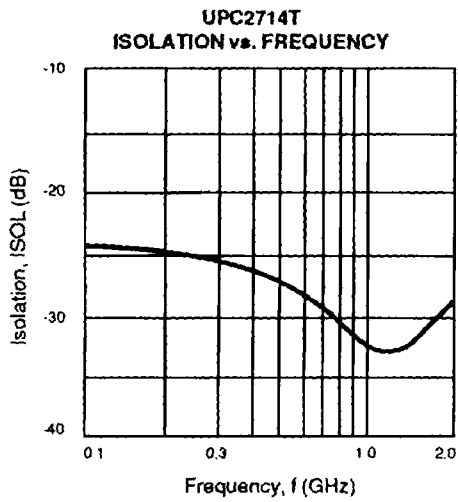
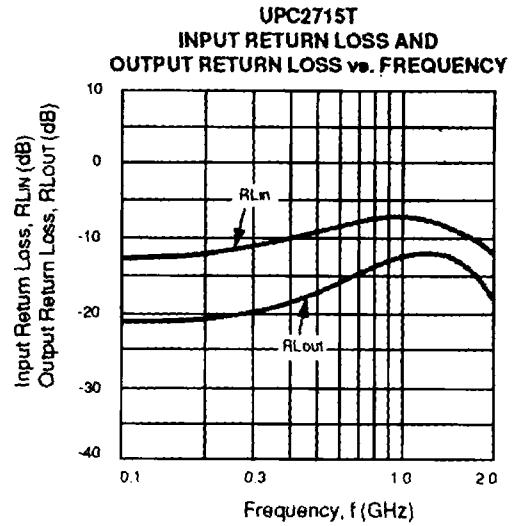
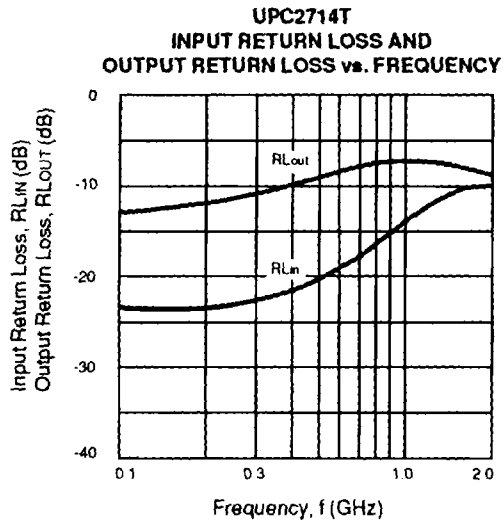

X: Typical SSB Third Order Intercept Point

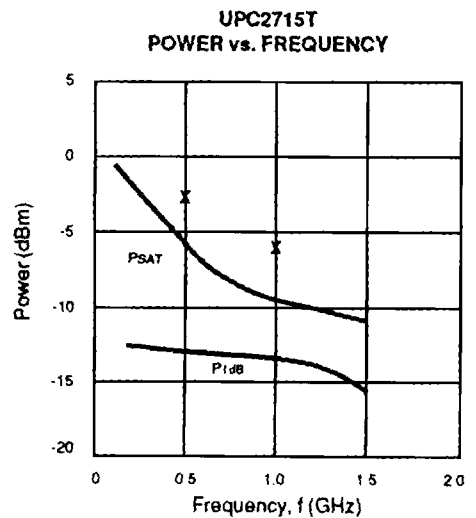

X: Typical SSB Third Order Intercept Point

TYPICAL PERFORMANCE CURVES (TA = 25°C)

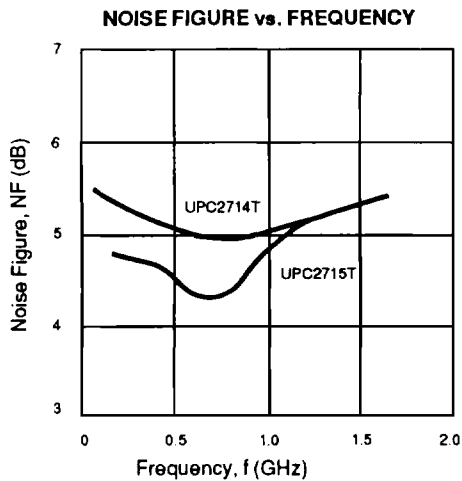
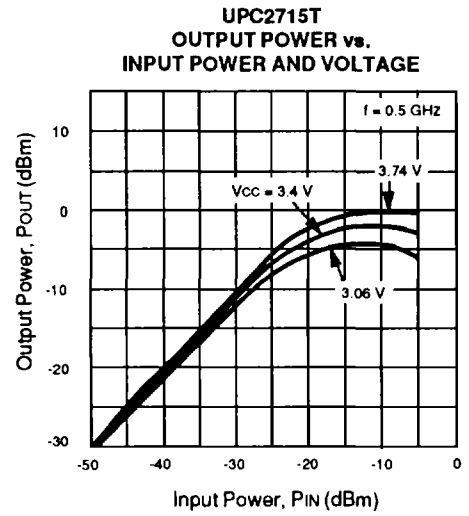
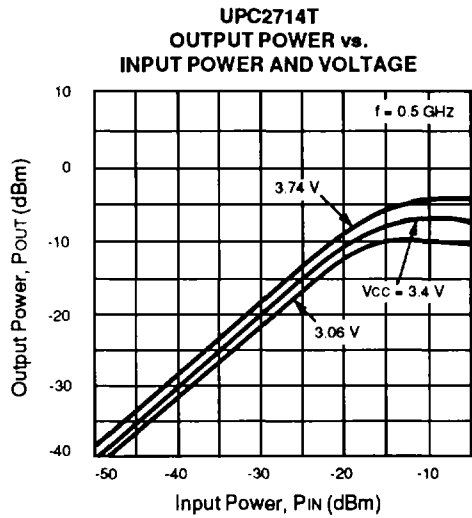
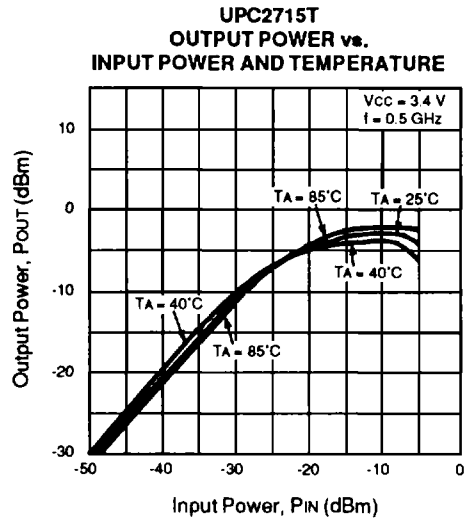
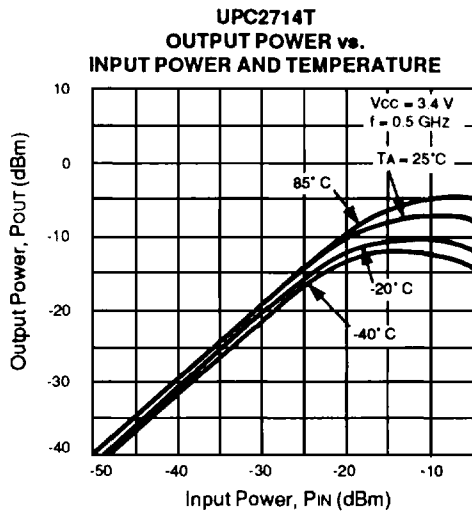

TEST CIRCUIT

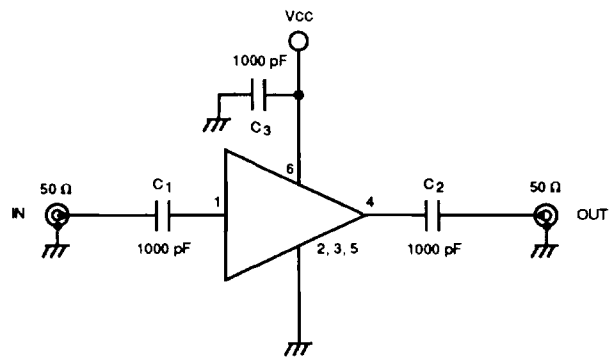

5

# UPC2714T, UPC2715T

## TYPICAL SCATTERING PARAMETERS (TA = 25°C)

### UPC2714T

Vcc = 3.4 V, Icc = 4.5 mA

FREQUENCY (GHz)	S11		S21		S12		S22		K <sup>1</sup>	S21 (dB)
	MAG	ANG	MAG	ANG	MAG	ANG	MAG	ANG		
0.10	0.123	-169.9	3.6	-6.4	0.069	-12.0	0.190	13.3	2.04	11.2
0.20	0.133	167.3	3.7	-19.2	0.061	-24.5	0.266	8.7	2.17	11.3
0.30	0.139	150.5	3.7	-30.6	0.056	-32.7	0.326	2.9	2.25	11.4
0.40	0.151	135.1	3.8	-41.8	0.048	-42.9	0.366	-4.0	2.49	11.5
0.50	0.165	120.6	3.8	-53.2	0.040	-48.8	0.394	-11.1	2.86	11.5
0.60	0.176	105.6	3.7	-64.7	0.035	-53.4	0.414	-19.4	3.19	11.4
0.70	0.187	91.5	3.7	-76.3	0.031	-52.7	0.429	-27.3	3.55	11.4
0.80	0.197	77.8	3.7	-87.9	0.025	-51.7	0.436	-35.3	4.36	11.3
0.90	0.205	64.6	3.6	-99.5	0.024	-47.1	0.439	-43.2	4.60	11.1
1.00	0.215	51.9	3.5	-111.1	0.022	-43.5	0.439	-50.6	5.08	11.0
1.10	0.219	39.2	3.4	-122.5	0.023	-38.2	0.432	-58.0	5.00	10.8
1.20	0.225	28.3	3.3	-133.8	0.024	-32.0	0.422	-64.8	4.96	10.5
1.30	0.228	17.3	3.2	-145.0	0.025	-31.8	0.412	-71.4	4.97	10.2
1.40	0.231	6.6	3.1	-156.1	0.026	-31.7	0.400	-77.8	5.01	9.8
1.50	0.231	-2.8	3.0	-166.8	0.028	-31.4	0.387	-83.4	4.90	9.5
1.60	0.232	-12.7	2.9	-177.4	0.029	-34.1	0.374	-88.9	4.97	9.1
1.70	0.231	-21.3	2.7	-172.2	0.030	-36.7	0.359	-94.1	5.11	8.7
1.80	0.229	-29.4	2.6	-162.0	0.032	-37.1	0.348	-98.5	5.08	8.3
1.90	0.226	-38.0	2.5	-151.9	0.033	-40.2	0.335	-103.2	5.20	7.9
2.00	0.223	-44.8	2.4	-142.3	0.035	-41.0	0.322	-107.4	5.21	7.5
2.10	0.216	-51.3	2.2	-132.3	0.036	-47.1	0.311	-111.5	5.39	7.0
2.20	0.212	-57.8	2.1	-122.8	0.037	-49.4	0.298	-115.3	5.57	6.6
2.30	0.208	-63.4	2.0	-113.7	0.039	-52.7	0.287	-118.9	5.61	6.2
2.40	0.204	-68.2	1.9	-104.6	0.040	-58.2	0.276	-122.2	5.81	5.7
2.50	0.201	-72.9	1.8	-95.6	0.041	-58.7	0.270	-125.7	5.97	5.3

### UPC2715T

Vcc = 3.4 V, Icc = 4.5 mA

FREQUENCY (GHz)	S11		S21		S12		S22		K <sup>1</sup>	S21 (dB)
	MAG	ANG	MAG	ANG	MAG	ANG	MAG	ANG		
0.10	0.052	33.7	7.7	-8.4	0.031	-7.8	0.254	8.1	2.07	17.7
0.20	0.087	21.3	7.8	-25.7	0.028	-12.6	0.279	3.6	2.20	17.8
0.30	0.121	9.5	7.9	-40.9	0.025	-17.8	0.311	-1.0	2.35	17.9
0.40	0.141	-2.1	7.9	-55.9	0.022	-20.3	0.351	-6.4	2.54	18.0
0.50	0.159	-12.4	7.9	-69.5	0.020	-21.2	0.383	-13.0	2.68	18.0
0.60	0.175	-27.8	7.7	-84.9	0.019	-19.7	0.409	-21.3	2.79	17.7
0.70	0.181	-40.7	7.4	-98.4	0.019	-15.7	0.426	-30.2	2.82	17.4
0.80	0.184	-52.3	7.2	-112.0	0.019	-13.3	0.432	-39.1	2.87	17.2
0.90	0.187	-66.1	6.9	-125.6	0.020	-12.3	0.432	-48.1	2.83	16.8
1.00	0.187	-78.4	6.6	-138.9	0.021	-11.2	0.426	-56.3	2.85	16.4
1.10	0.186	-89.3	6.3	-150.8	0.022	-11.6	0.412	-64.2	2.87	16.0
1.20	0.182	-101.5	6.1	-162.7	0.023	-12.1	0.394	-71.2	2.93	15.6
1.30	0.178	-113.8	5.7	-174.5	0.024	-14.5	0.377	-77.5	3.06	15.0
1.40	0.173	-125.4	5.3	-174.3	0.025	-16.3	0.359	-83.4	3.22	14.4
1.50	0.167	-137.1	4.9	-163.7	0.026	-18.3	0.343	-88.3	3.35	13.9
1.60	0.163	-148.4	4.6	-153.2	0.027	-20.6	0.328	-93.1	3.53	13.2
1.70	0.157	-160.0	4.2	-143.1	0.028	-22.2	0.315	-97.2	3.72	12.5
1.80	0.152	-171.6	3.9	-133.2	0.029	-23.9	0.306	-100.8	3.90	11.9
1.90	0.148	-176.8	3.7	-123.5	0.030	-25.6	0.296	-104.7	4.07	11.3
2.00	0.142	-164.7	3.4	-114.5	0.031	-27.1	0.286	-108.9	4.28	10.6

Note:

1. K factor calculations: 
$$K = \frac{1 + |\Delta|^2 - |S_{11}|^2 - |S_{22}|^2}{2 |S_{12} S_{21}|}, \Delta = S_{11} S_{22} - S_{21} S_{12}$$

**EQUIVALENT CIRCUIT**

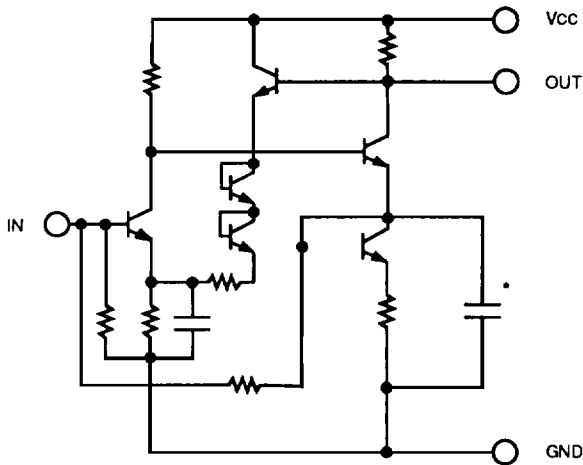

\*Used in UPC2714T only

**LEAD CONNECTIONS**

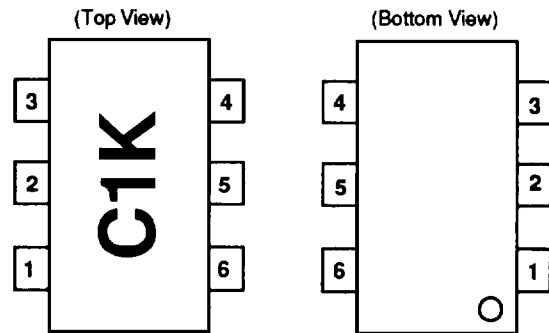

- 1. INPUT
- 2. GND
- 3. GND
- 4. OUTPUT
- 5. GND
- 6. Vcc

Note: Package Markings:  
C1K - UPC2714T  
C1L - UPC2715T

**OUTLINE DIMENSIONS (Units in mm)**

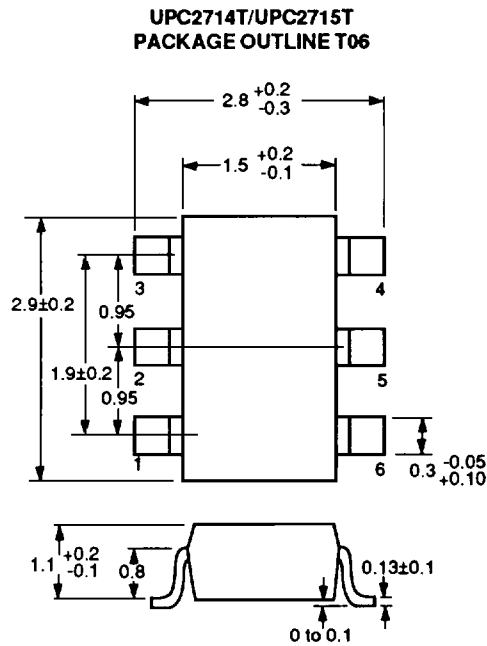

Note:  
All dimensions are typical unless otherwise noted.

**RECOMMENDED P.C.B. LAYOUT (Units in mm)**

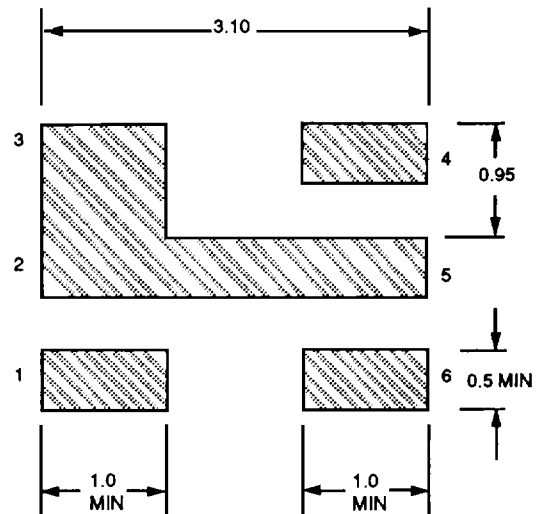

**ORDERING INFORMATION**

PART NUMBER	QTY
UPC2714T-E3	3K/Reel
UPC2715T-E3	3K/Reel

Embossed Tape, 8 mm wide.  
Pins 1, 2, 3 are in tape pull-out direction.