

DUAL SMALL SIGNAL SURFACE MOUNT TRANSISTOR

LMBT5541DW1T1G

FEATURE

- We declare that the material of product is ROHS compliant and halogen free.

DEVICE MARKING AND ORDERING INFORMATION

Device	Marking	Shipping
LMBT5541DW1T1G	GL	3000/Tape&Reel
LMBT5541DW1T3G	GL	10000/Tape&Reel

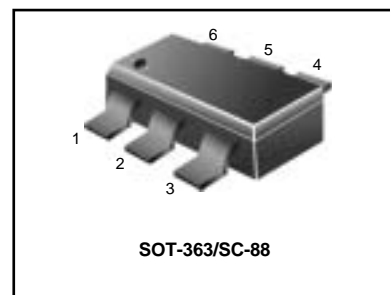

MAXIMUM RATINGS – NPN

Rating	Symbol	Value	Unit
Collector–Emitter Voltage	V_{CE0}	140	Vdc
Collector–Base Voltage	V_{CBO}	160	Vdc
Emitter–Base Voltage	V_{EBO}	6.0	Vdc
Collector Current — Continuous	I_C	600	mAdc

MAXIMUM RATINGS – PNP

Rating	Symbol	Value	Unit
Collector–Emitter Voltage	V_{CE0}	-150	Vdc
Collector–Base Voltage	V_{CBO}	-160	Vdc
Emitter–Base Voltage	V_{EBO}	-5.0	Vdc
Collector Current — Continuous	I_C	-500	mAdc

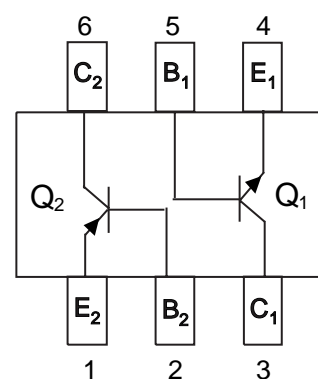

THERMAL CHARACTERISTICS

Characteristic	Symbol	Max	Unit
Total Device Dissipation FR– 5 Board, (1) $T_A = 25^\circ\text{C}$	P_D	225	mW
Derate above 25°C		1.8	mW/ $^\circ\text{C}$
Thermal Resistance, Junction to Ambient	$R_{\theta JA}$	556	$^\circ\text{C}/\text{W}$
Total Device Dissipation Alumina Substrate, (2) $T_A = 25^\circ\text{C}$	P_D	300	mW
Derate above 25°C		2.4	mW/ $^\circ\text{C}$
Thermal Resistance, Junction to Ambient	$R_{\theta JA}$	417	$^\circ\text{C}/\text{W}$
Junction and Storage Temperature	T_J, T_{stg}	-55 to +150	$^\circ\text{C}$

1. FR–5 = 1.0 x 0.75 x 0.062 in.
2. Alumina = 0.4 x 0.3 x 0.024 in. 99.5% alumina.

LMBT5541DW1T1G

Q1 ELECTRICAL CHARACTERISTICS (T_A = 25°C unless otherwise noted.)

Characteristic	Symbol	Min	Max	Unit
----------------	--------	-----	-----	------

OFF CHARACTERISTICS

Collector–Emitter Breakdown Voltage(3) (I _C = 1.0 mA _{dc} , I _B = 0)	V _{(BR)CEO}	160	—	V _{dc}
Collector–Base Breakdown Voltage (I _C = 100 μA _{dc} , I _E = 0)	V _{(BR)CBO}	180	—	V _{dc}
Emitter–Base Breakdown Voltage (I _E = 10 μA _{dc} , I _C = 0)	V _{(BR)EBO}	6.0	—	V _{dc}
Collector Cutoff Current (V _{CB} = 120V _{dc} , I _E = 0)	I _{CBO}	—	50	nA _{dc}
(V _{CB} = 120V _{dc} , I _E = 0, T _A = 100 °C)		—	50	μA _{dc}
Emitter Cutoff Current (V _{BE} = 4.0V _{dc} , I _C = 0)	I _{EBO}	—	50	nA _{dc}

- FR-5 = 1.0 x 0.75 x 0.062 in.
- Alumina = 0.4 x 0.3 x 0.024 in. 99.5% alumina.
- Pulse Test: Pulse Width = 300 μs, Duty Cycle = 2.0%.

ON CHARACTERISTICS

DC Current Gain (I _C = 1.0 mA _{dc} , V _{CE} = 5.0 V _{dc}) (I _C = 10 mA _{dc} , V _{CE} = 5.0 V _{dc}) (I _C = 50 mA _{dc} , V _{CE} = 5.0V _{dc})	h _{FE}	80 80 30	— 250 —	—
Collector–Emitter Saturation Voltage (I _C = 10 mA _{dc} , I _B = 1.0 mA _{dc}) (I _C = 50 mA _{dc} , I _B = 5.0 mA _{dc})	V _{CE(sat)}	— —	0.15 0.20	V _{dc}
Base–Emitter Saturation Voltage (I _C = 10 mA _{dc} , I _B = 1.0 mA _{dc}) (I _C = 50 mA _{dc} , I _B = 5.0 mA _{dc})	V _{BE(sat)}	— —	1.0 1.0	V _{dc}

LMBT5541DW1T1G
Q2 ELECTRICAL CHARACTERISTICS ($T_A = 25^\circ\text{C}$ unless otherwise noted)

Characteristic	Symbol	Min	Max	Unit
OFF CHARACTERISTICS				
Collector–Emitter Breakdown Voltage ($I_C = -1.0\text{ mAdc}$, $I_B = 0$)	$V_{(BR)CEO}$	-150	—	Vdc
Collector–Base Breakdown Voltage ($I_C = -100\ \mu\text{Adc}$, $I_E = 0$)	$V_{(BR)CBO}$	-160	—	Vdc
Emitter–Base Breakdown Voltage ($I_E = -10\ \mu\text{Adc}$, $I_C = 0$)	$V_{(BR)EBO}$	-5.0	—	Vdc
Collector Cutoff Current ($V_{CB} = -120\text{ Vdc}$, $I_E = 0$)	I_{CBO}	—	-50	nAdc
($V_{CB} = -120\text{ Vdc}$, $I_E = 0$, $T_A = 100^\circ\text{C}$)		—	-50	μAdc

1. FR-5 = 1.0 x 0.75 x 0.062 in.

2. Alumina = 0.4 x 0.3 x 0.024 in. 99.5% alumina.

ON CHARACTERISTICS (2)

DC Current Gain ($I_C = -1.0\text{ mAdc}$, $V_{CE} = -5.0\text{ Vdc}$)	h_{FE}	50	—	—
($I_C = -10\text{ mAdc}$, $V_{CE} = -5.0\text{ Vdc}$)		60	240	
($I_C = -50\text{ mAdc}$, $V_{CE} = -5.0\text{ Vdc}$)		50	—	
Collector–Emitter Saturation Voltage ($I_C = -10\text{ mAdc}$, $I_B = -1.0\text{ mAdc}$)	$V_{CE(sat)}$	—	-0.2	Vdc
($I_C = -50\text{ mAdc}$, $I_B = -5.0\text{ mAdc}$)		—	-0.5	
Base–Emitter Saturation Voltage ($I_C = -10\text{ mAdc}$, $I_B = -1.0\text{ mAdc}$)	$V_{BE(sat)}$	—	-1.0	Vdc
($I_C = -50\text{ mAdc}$, $I_B = -5.0\text{ mAdc}$)		—	-1.0	

SMALL–SIGNAL CHARACTERISTICS

Current–Gain — Bandwidth Product ($I_C = -10\text{ mAdc}$, $V_{CE} = -10\text{ Vdc}$, $f = 100\text{ MHz}$)	f_T	100	300	MHz
Output Capacitance ($V_{CB} = -10\text{ Vdc}$, $I_E = 0$, $f = 1.0\text{ MHz}$)	C_{obo}	—	6.0	pF
Small–Signal Current Gain ($I_C = -1.0\text{ mAdc}$, $V_{CE} = -10\text{ Vdc}$, $f = 1.0\text{ kHz}$)	h_{fe}	40	200	—
Noise Figure ($I_C = -200\ \mu\text{Adc}$, $V_{CE} = -5.0\text{ Vdc}$, $R_s = 10\ \Omega$, $f = 1.0\text{ kHz}$)	NF	—	8.0	dB

LMBT5541DW1T1G

Q1 TYPICAL PNP CHARACTERISTICS

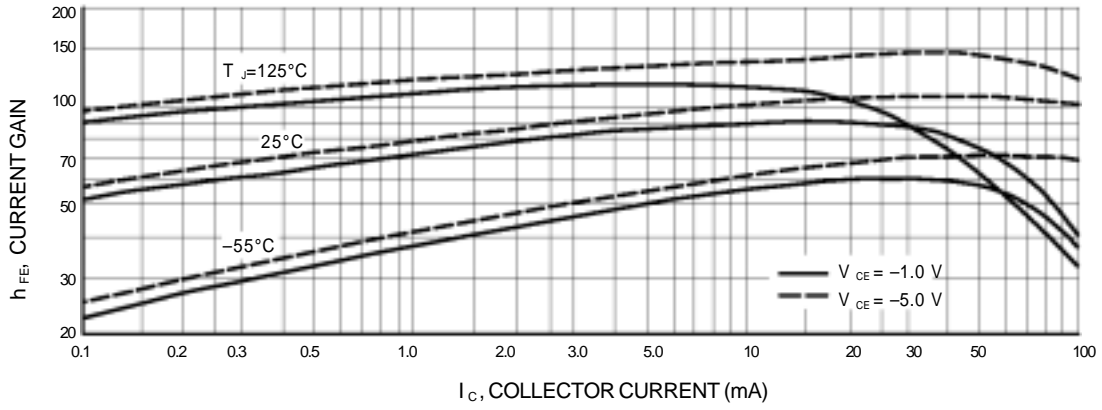

Figure 1. DC Current Gain

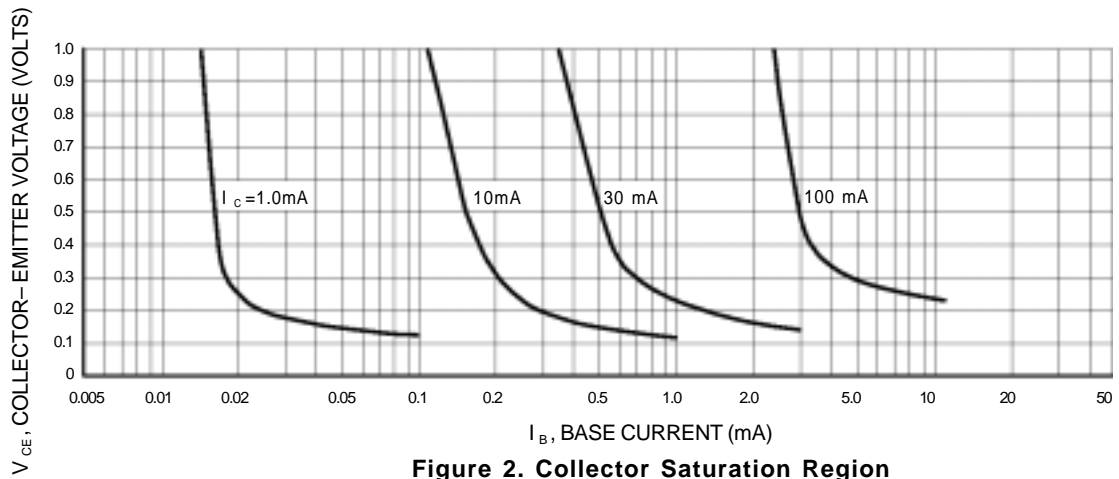

Figure 2. Collector Saturation Region

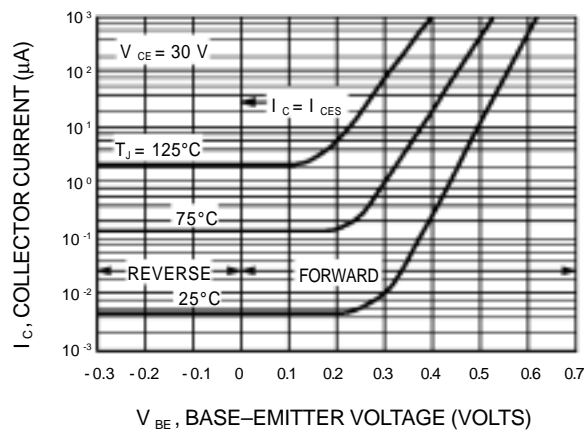

Figure 3. Collector Cut-Off Region

LMBT5541DW1T1G

Q1 TYPICAL PNP CHARACTERISTICS

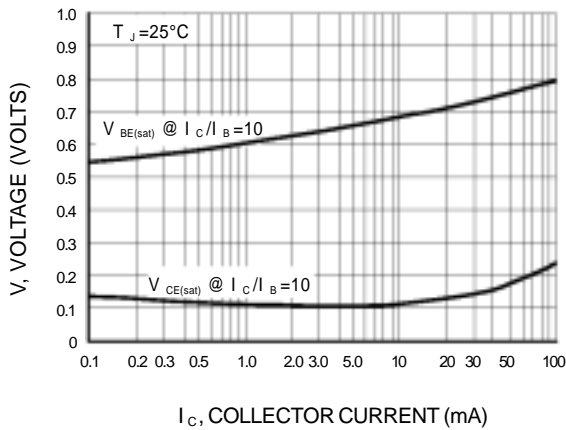

Figure 4. "On" Voltages

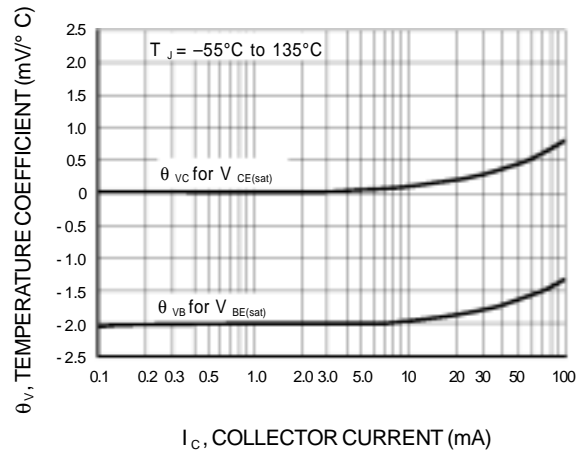

Figure 5. Temperature Coefficients

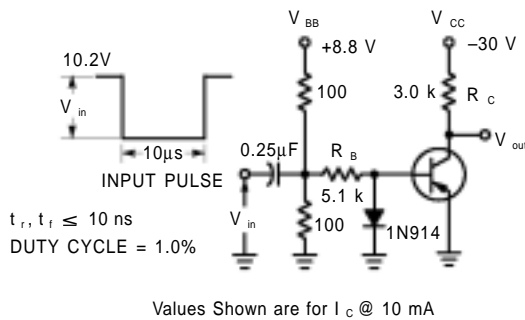

Figure 6. Switching Time Test Circuit

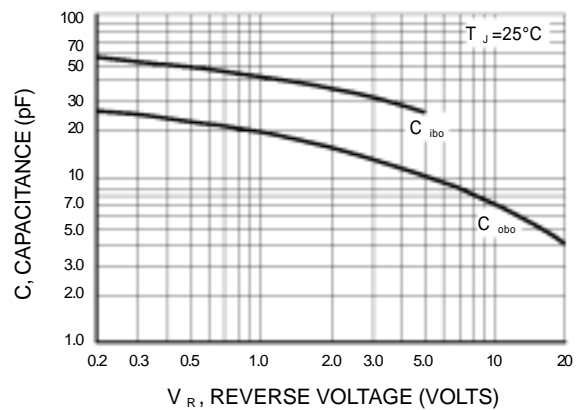

Figure 7. Capacitances

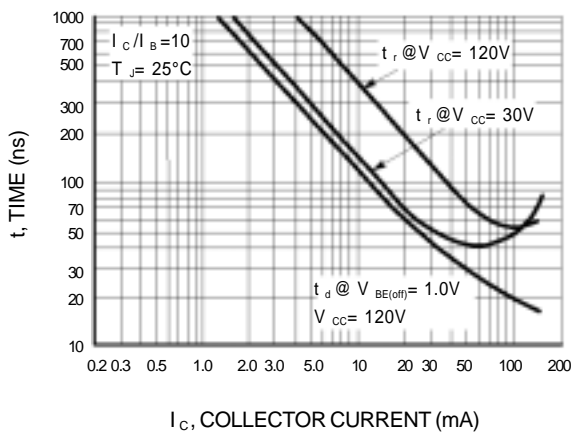

Figure 8. Turn-On Time

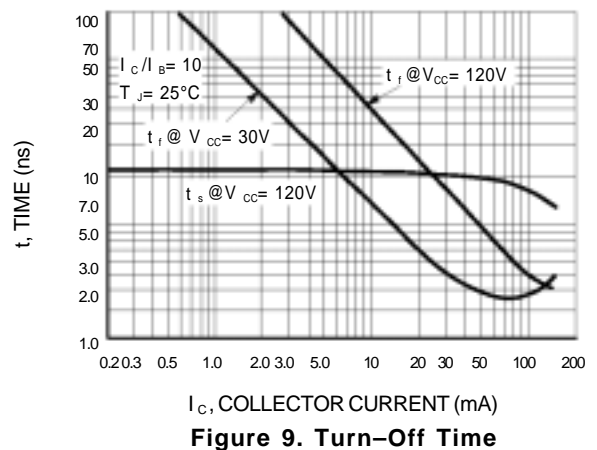

Figure 9. Turn-Off Time

LMBT5541DW1T1G

Q2 TYPICAL NPN CHARACTERISTICS

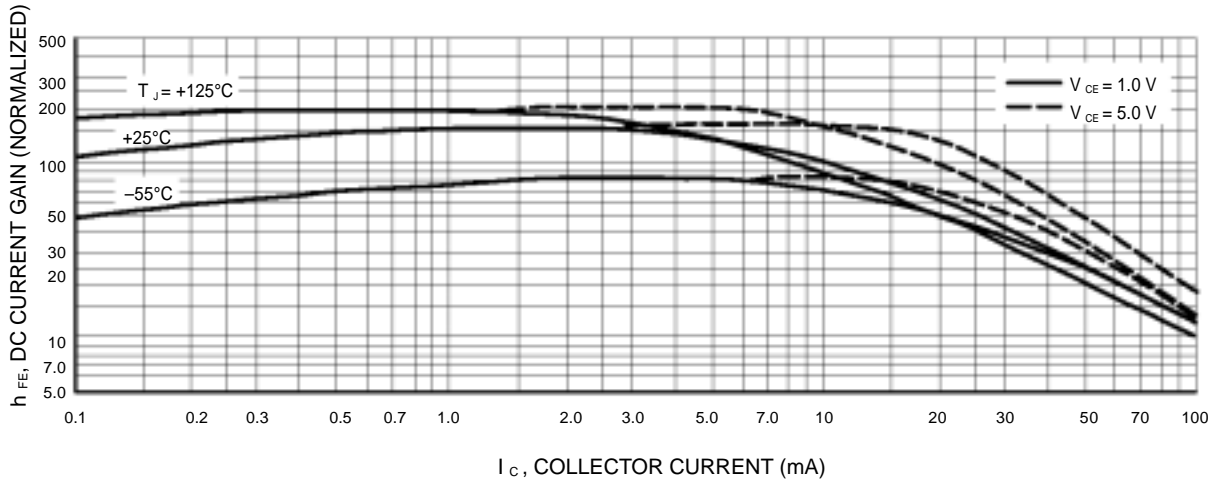

Figure 15. DC Current Gain

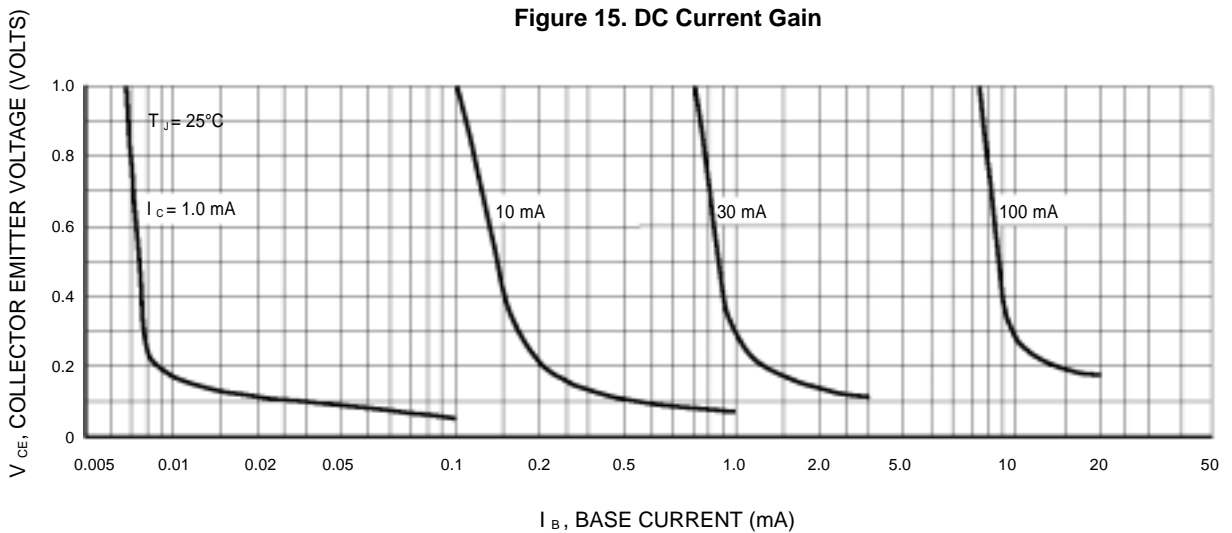

Figure 16. Collector Saturation Region

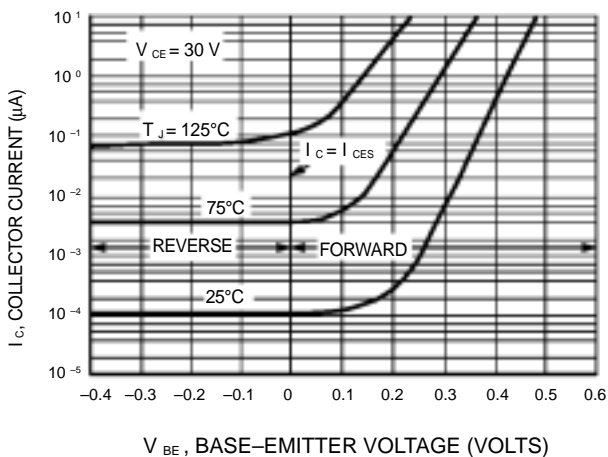

Figure 3. Collector Cut-Off Region

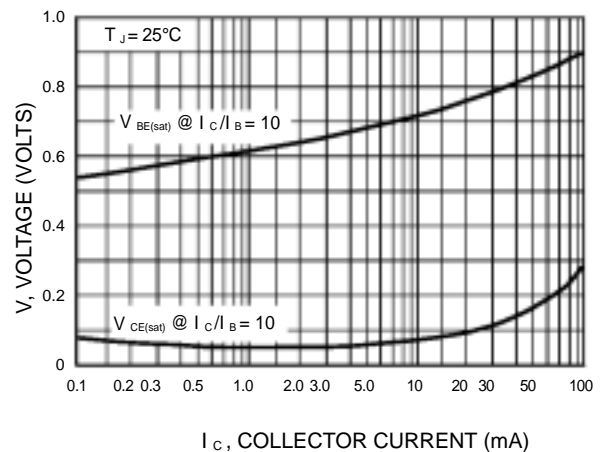

Figure 4. "On" Voltages

LMBT5541DW1T1G

Q2 TYPICAL NPN CHARACTERISTICS

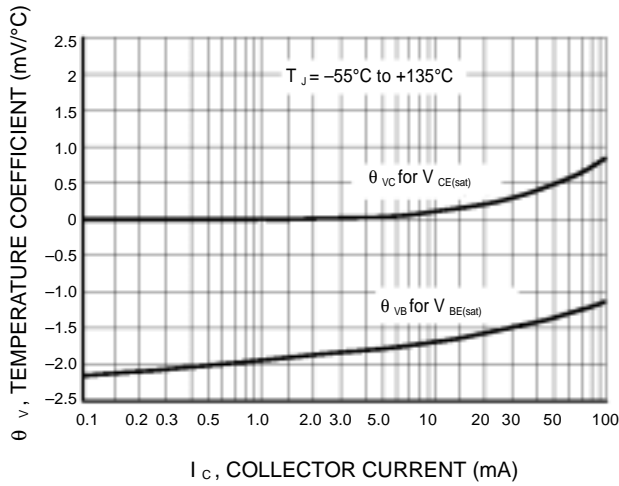
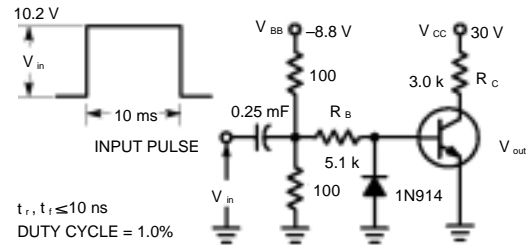

Figure 5. Temperature Coefficients



Values Shown are for $I_c @ 10\text{ mA}$

Figure 6. Switching Time Test Circuit

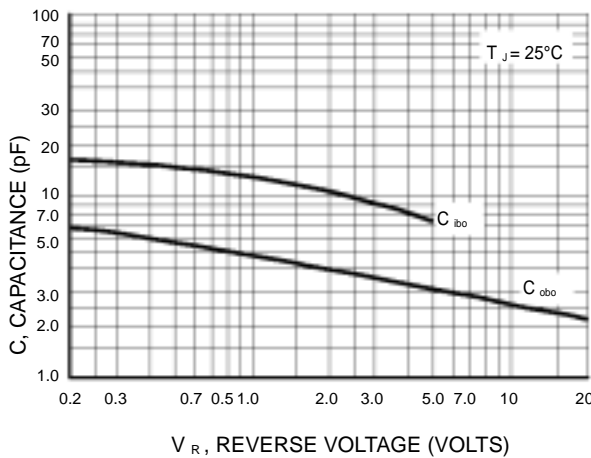
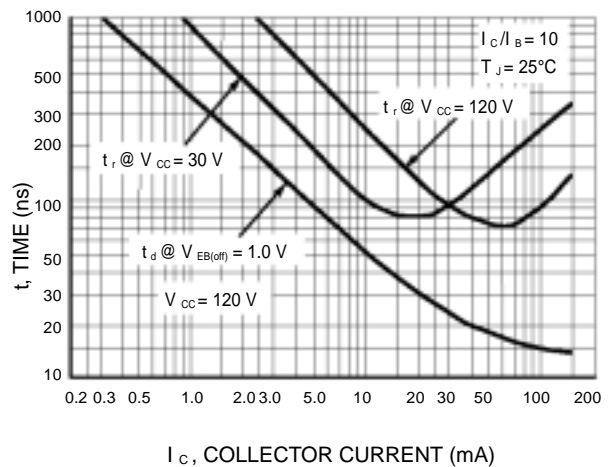

Figure 7. Capacitances



8. Turn-On Time

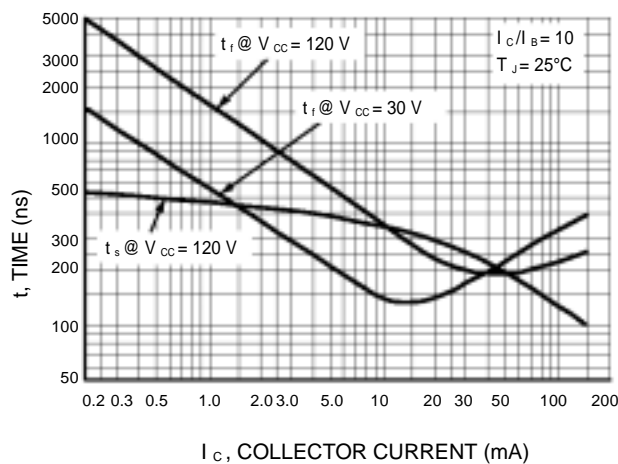
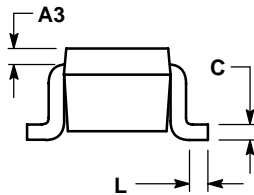
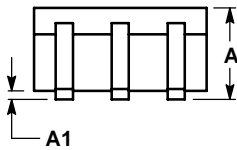
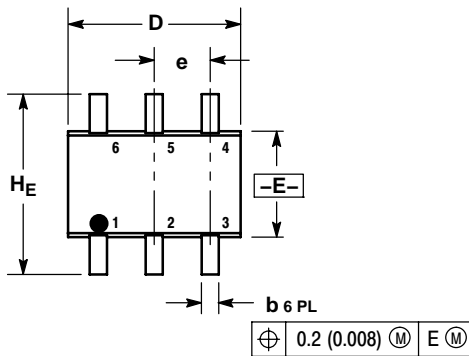

Figure 9. Turn-Off Time

LMBT5551DW1T1G

SC-88



NOTES:

1. DIMENSIONING AND TOLERANCING PER ANSI Y14.5M, 1982.
2. CONTROLLING DIMENSION: INCH.
3. 419B-01 OBSOLETE, NEW STANDARD 419B-02.

DIM	MILLIMETERS			INCHES		
	MIN	NOM	MAX	MIN	NOM	MAX
A	0.80	0.95	1.10	0.031	0.037	0.043
A1	0.00	0.05	0.10	0.000	0.002	0.004
A3	0.20 REF			0.008 REF		
b	0.10	0.21	0.30	0.004	0.008	0.012
C	0.10	0.14	0.25	0.004	0.005	0.010
D	1.80	2.00	2.20	0.070	0.078	0.086
E	1.15	1.25	1.35	0.045	0.049	0.053
e	0.65 BSC			0.026 BSC		
L	0.10	0.20	0.30	0.004	0.008	0.012
HE	2.00	2.10	2.20	0.078	0.082	0.086

GENERIC MARKING DIAGRAM*

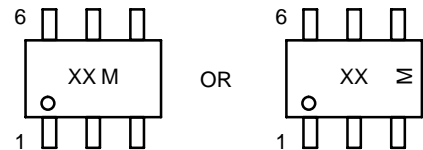

XX = Specific Device Code
M = Date Code