

### Features

- Planar Die Construction
- 500mW Power Dissipation
- 2.4V – 51V Nominal Zener Voltage
- 5% Standard Vz Tolerance
- Designed for Surface Mount Application
- Plastic Material – UL Recognition Flammability Classification 94V-0

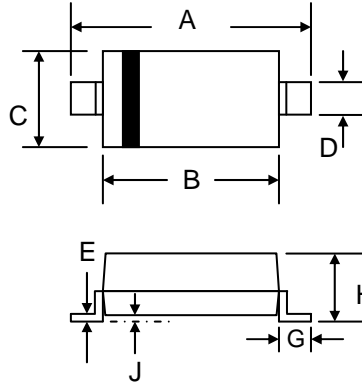

SOD-123		
Dim	Min	Max
A	3.6	3.9
B	2.5	2.8
C	1.4	1.8
D	0.5	0.7
E	—	0.2
G	0.4	—
H	0.95	1.35
J	—	0.12
All Dimensions in mm		

### Mechanical Data

- Case: SOD-123, Molded Plastic
- Terminals: Plated Leads Solderable per MIL-STD-202, Method 208
- Polarity: Cathode Band
- Weight: 0.01 grams (approx.)
- Marking: Device Code
- **Lead Free: For RoHS / Lead Free Version, Add “-LF” Suffix to Part Number, See Page 5**

### Maximum Ratings @T<sub>A</sub>=25°C unless otherwise specified

Characteristic	Symbol	Value	Unit
Power Dissipation at T <sub>L</sub> = 75°C (Note 1)	P <sub>D</sub>	500	mW
Forward Voltage @ I <sub>F</sub> = 10mA	V <sub>F</sub>	0.9	V
Thermal Resistance, Junction to Ambient (Note 2, 3)	R <sub>JA</sub>	340	°C/W
Thermal Resistance, Junction to Lead (Note 2, 3)	R <sub>JL</sub>	150	°C/W
Operating and Storage Temperature Range	T <sub>J</sub> , T <sub>STG</sub>	-65 to +150	°C

Note: 1. Mounted on FR-4 PCB with minimum recommended pad layout.  
 2. Thermal resistance measurement obtained via infrared scan method.

# MMSZ5221B – MMSZ5262B

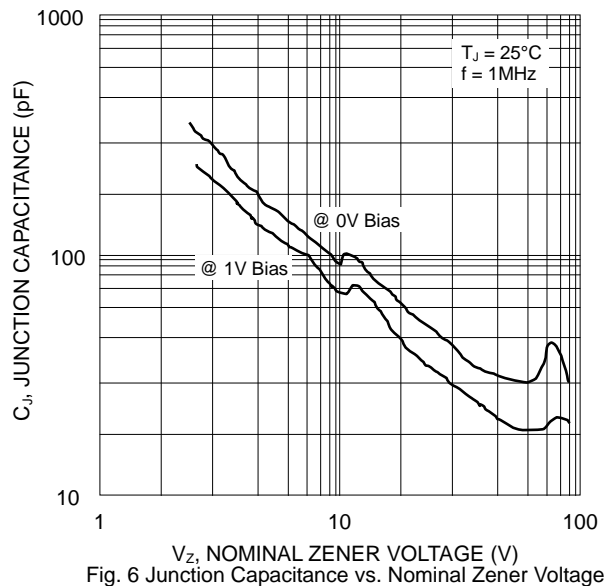
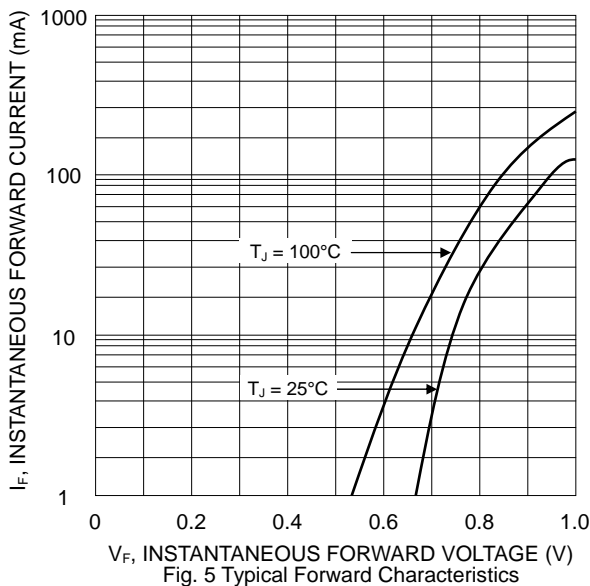
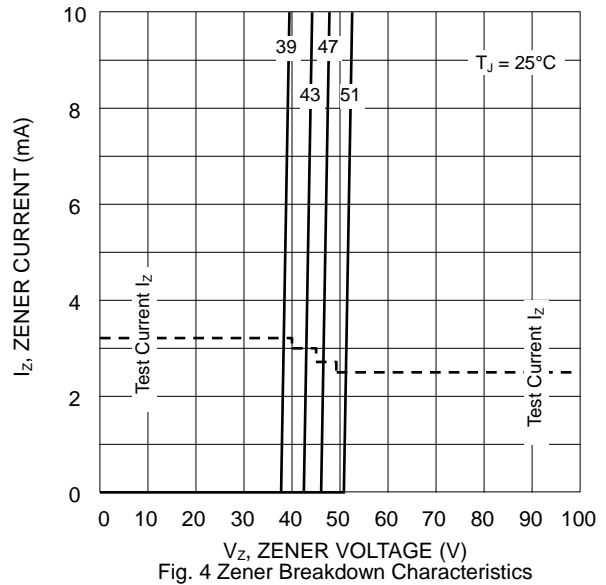
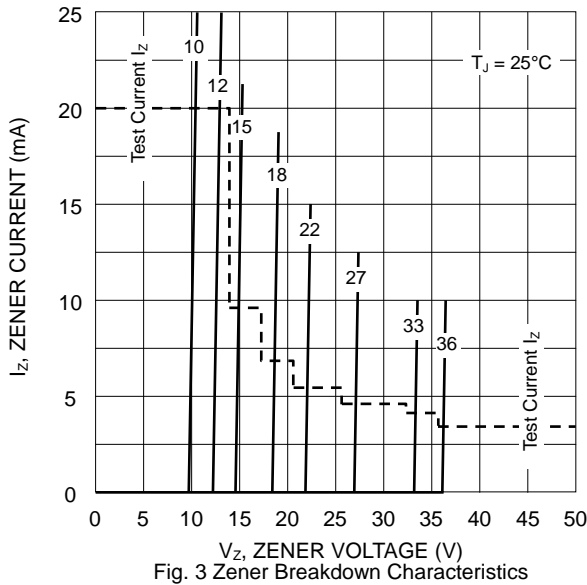
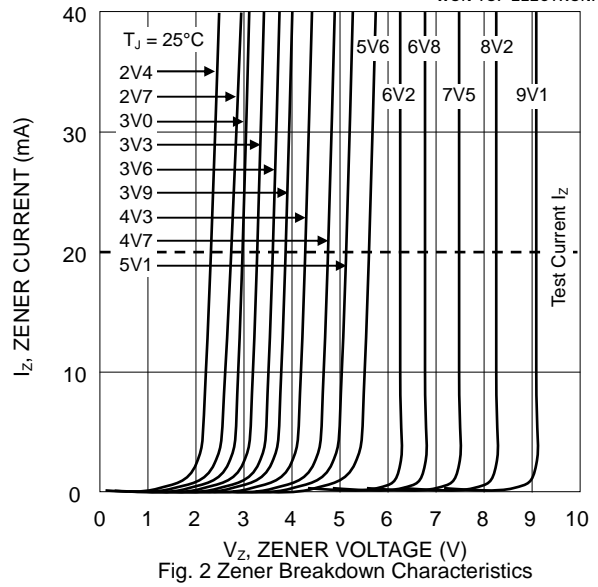
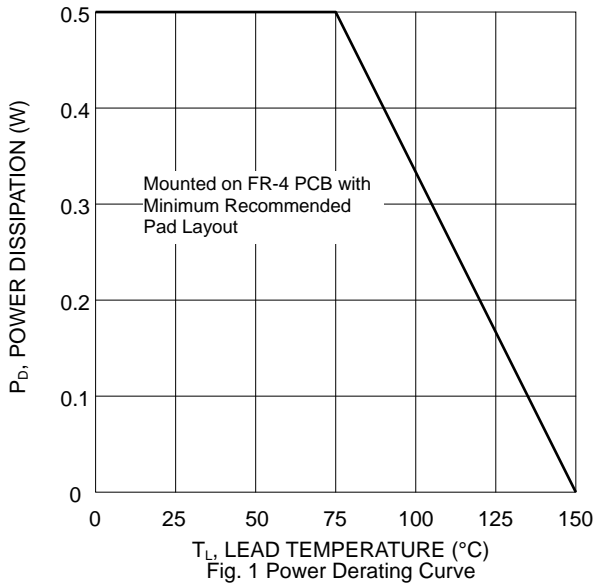

**Electrical Characteristics (@T<sub>A</sub>=25°C unless otherwise specified) Table 1**

Type Number (Note 1)	Device Marking Code (Note 2)		Zener Voltage Range (Note 3)			Maximum Zener Impedance (Note 4)				Max Reverse Leakage Current		Typical Temp. Coefficient of Zener Voltage
			V <sub>Z</sub> @ I <sub>ZT</sub>			Z <sub>ZT</sub> @ I <sub>ZT</sub>		Z <sub>ZK</sub> @ I <sub>ZK</sub>		I <sub>R</sub>	@ V <sub>R</sub>	
	TW	CN	Nom (V)	Min (V)	Max (V)	( )	(mA)	( )	(mA)	(μA)	(V)	(%/°C)
MMSZ5221B	C1	C1	2.4	2.28	2.52	30	20	1200	0.25	100	1.0	-0.075
MMSZ5222B	C2	C2	2.5	2.38	2.63	30	20	1250	0.25	100	1.0	-0.075
MMSZ5223B	C3	C3	2.7	2.57	2.84	30	20	1300	0.25	75	1.0	-0.075
MMSZ5225B	C5	C5	3.0	2.85	3.15	29	20	1600	0.25	50	1.0	-0.075
MMSZ5226B	D1	G1	3.3	3.14	3.47	28	20	1600	0.25	25	1.0	-0.070
MMSZ5227B	D2	G2	3.6	3.42	3.78	24	20	1700	0.25	15	1.0	-0.065
MMSZ5228B	D3	G3	3.9	3.71	4.10	23	20	1900	0.25	10	1.0	-0.060
MMSZ5229B	D4	G4	4.3	4.09	4.52	22	20	2000	0.25	5.0	1.0	-0.055
MMSZ5230B	D5	G5	4.7	4.47	4.94	19	20	1900	0.25	5.0	2.0	±0.030
MMSZ5231B	E1	E1	5.1	4.85	5.36	17	20	1600	0.25	5.0	2.0	±0.030
MMSZ5232B	E2	E2	5.6	5.32	5.88	11	20	1600	0.25	5.0	3.0	+0.038
MMSZ5233B	E3	E3	6.0	5.70	6.30	7.0	20	1600	0.25	5.0	3.5	+0.038
MMSZ5234B	E4	E4	6.2	5.89	6.51	7.0	20	1000	0.25	5.0	4.0	+0.045
MMSZ5235B	E5	E5	6.8	6.46	7.14	5.0	20	750	0.25	3.0	5.0	+0.050
MMSZ5236B	F1	F1	7.5	7.13	7.88	6.0	20	500	0.25	3.0	6.0	+0.058
MMSZ5237B	F2	F2	8.2	7.79	8.61	8.0	20	500	0.25	3.0	6.5	+0.062
MMSZ5238B	F3	F3	8.7	8.27	9.14	8.0	20	600	0.25	3.0	6.5	+0.065
MMSZ5239B	F4	F4	9.1	8.65	9.56	10	20	600	0.25	3.0	7.0	+0.068
MMSZ5240B	F5	F5	10	9.50	10.50	17	20	600	0.25	3.0	8.0	+0.075
MMSZ5241B	H1	H1	11	10.45	11.55	22	20	600	0.25	2.0	8.4	+0.076
MMSZ5242B	H2	H2	12	11.40	12.60	30	20	600	0.25	1.0	9.1	+0.077
MMSZ5243B	H3	H3	13	12.35	13.65	13	9.5	600	0.25	0.5	9.9	+0.079
MMSZ5245B	H5	H5	15	14.25	15.75	16	8.5	600	0.25	0.1	11	+0.082
MMSZ5246B	J1	J1	16	15.20	16.80	17	7.8	600	0.25	0.1	12	+0.083
MMSZ5248B	J3	J3	18	17.10	18.90	21	7.0	600	0.25	0.1	14	+0.085
MMSZ5250B	J5	J5	20	19.00	21.00	25	6.2	600	0.25	0.1	15	+0.086
MMSZ5251B	K1	K1	22	20.90	23.10	29	5.6	600	0.25	0.1	17	+0.087
MMSZ5252B	K2	K2	24	22.80	25.20	33	5.2	600	0.25	0.1	18	+0.087
MMSZ5254B	K4	K4	27	25.65	28.35	41	4.6	600	0.25	0.1	21	+0.090
MMSZ5255B	K5	K5	28	26.60	29.40	44	4.5	600	0.25	0.1	21	+0.091
MMSZ5256B	M1	M1	30	28.50	31.50	49	4.2	600	0.25	0.1	23	+0.091
MMSZ5257B	M2	M2	33	31.35	34.65	58	3.8	700	0.25	0.1	25	+0.092
MMSZ5258B	M3	M3	36	34.20	37.80	70	3.4	700	0.25	0.1	27	+0.093
MMSZ5259B	M4	M4	39	37.05	40.95	80	3.2	800	0.25	0.1	30	+0.094
MMSZ5260B	M5	M5	43	40.85	45.15	93	3.0	900	0.25	0.1	33	+0.095
MMSZ5261B	N1	N1	47	44.65	49.35	105	2.7	1000	0.25	0.1	36	+0.095
MMSZ5262B	N2	N2	51	48.45	53.55	125	2.5	1100	0.25	0.1	39	+0.096

- Note: 1. Type numbers listed have standard tolerance on the nominal zener voltage of ±5%.  
 2. TW: Marking code for Taiwan plant. CN: Marking code for China plant.  
 3. Measured with device junction in thermal equilibrium.  
 4. f = 1KHz

## MARKING INFORMATION



Cathode = Polarity Band  
xx = Device Code, See Table 1

## RECOMMENDED FOOTPRINT

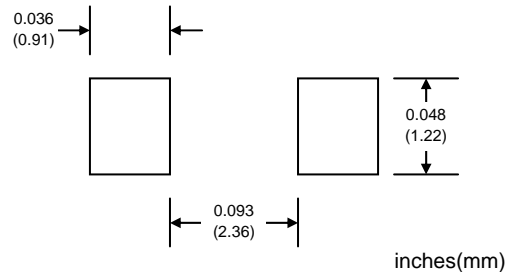

## PACKAGING INFORMATION

### TAPE & REEL

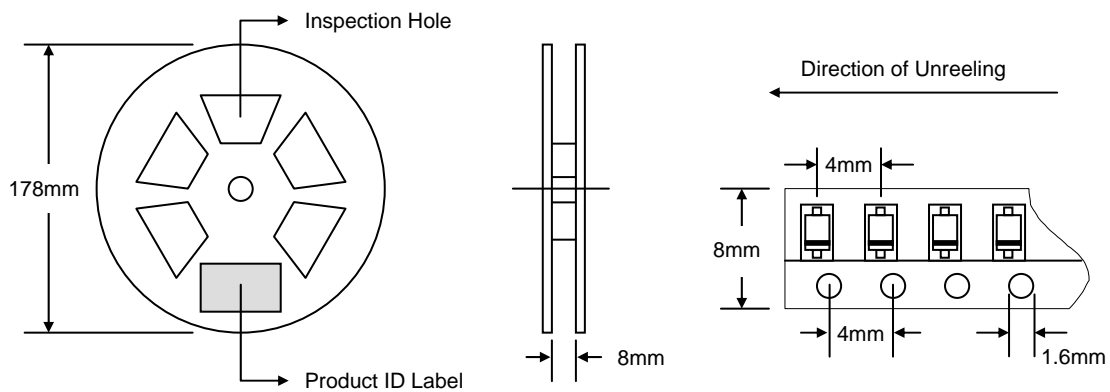

Reel Diameter (mm)	Quantity (PCS)	Inner Box Size L x W x H (mm)	Quantity (PCS)	Carton Size L x W x H (mm)	Quantity (PCS)	Approx. Gross Weight (KG)
178	3,000	187 x 187 x 65	15,000	390 x 240 x 420	150,000	10.0

**Note:** 1. Anti-static plastic reel, white, water clear or blue color. Inspection hole might be varied in different alignment.  
2. Components are packed in accordance with EIA standard 481-1 and 481-2.

## ORDERING INFORMATION

Product No.	Package Type	Shipping Quantity
MMSZ52xxB-T1	SOD-123	3000/Tape & Reel

1. Shipping quantity given is for minimum packing quantity only. For minimum order quantity, please consult the Sales Department.
2. **To order RoHS / Lead Free version (with Lead Free finish), add "-LF" suffix to part number above. For example, MMSZ5221B-T1-LF.**

WON-TOP ELECTRONICS and  are registered trademarks of Won-Top Electronics Co., Ltd (WTE). WTE has checked all information carefully and believes it to be correct and accurate. However, WTE cannot assume any responsibility for inaccuracies. Furthermore, this information does not give the purchaser of semiconductor devices any license under patent rights to manufacturer. WTE reserves the right to change any or all information herein without further notice.

**WARNING:** DO NOT USE IN LIFE SUPPORT EQUIPMENT. WTE power semiconductor products are not authorized for use as critical components in life support devices or systems without the express written approval.

**Won-Top Electronics Co., Ltd.**  
No. 44 Yu Kang North 3rd Road,  
Chine Chen Dist., Kaohsiung 806, Taiwan  
**Phone:** 886-7-822-5408 or 886-7-822-5410  
**Fax:** 886-7-822-5417  
**Email:** sales@wontop.com  
**Internet:** <http://www.wontop.com>

*We power your everyday.*