

Features

- ✧ Glass passivated chip junction
- ✧ High efficiency, Low VF
- ✧ High current capability
- ✧ High reliability
- ✧ High surge current capability
- ✧ Low power loss
- ✧ Green compound with suffix "G" on packing code & prefix "G" on datecode

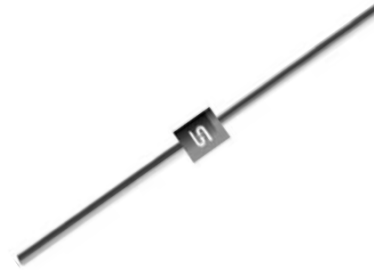

Mechanical Data

- ✧ Cases: Molded plastic
- ✧ Epoxy: UL 94V-0 rate flame retardant
- ✧ Lead: Pure tin plated, lead free, solderable per MIL-STD-202, Method 208 guaranteed
- ✧ Polarity: Color band denotes cathode end
- ✧ High temperature soldering guaranteed: 260°C/10s
- ✧ Weight: 0.40 grams

Ordering Information (example)

Part No.	Package	Packing	INNER TAPE	Packing code	Packing code (Green)
FR151G	DO-15	1.5K / AMMO box	52mm	A0	A0G

Maximum Ratings and Electrical Characteristics

Rating at 25 °C ambient temperature unless otherwise specified.

Parameter	Symbol	FR 151G	FR 152G	FR 153G	FR 154G	FR 155G	FR 156G	FR 157G	Units
Maximum Recurrent Peak Reverse Voltage	V_{RRM}	50	100	200	400	600	800	1000	V
Maximum RMS Voltage	V_{RMS}	35	70	140	280	420	560	700	V
Maximum DC Blocking Voltage	V_{DC}	50	100	200	400	600	800	1000	V
Maximum Average Forward Rectified Current	$I_{F(AV)}$	1.5							A
Peak Forward Surge Current, 8.3 ms Single Half Sine-wave Superimposed on Rated Load (JEDEC method)	I_{FSM}	50							A
Maximum Instantaneous Forward Voltage (Note 1) @ 1.5A	V_F	1.3							V
Maximum DC Reverse Current at @ $T_A=25\text{ }^\circ\text{C}$	I_R	5							uA
Rated DC Blocking Voltage @ $T_A=125\text{ }^\circ\text{C}$		150							uA
Maximum Reverse Recovery Time (Note 2)	T_{rr}	150			250	500		nS	
Typical Junction Capacitance (Note 3)	C_j	20							pF
Typical Thermal Resistance	$R_{\theta JA}$	60							$^\circ\text{C/W}$
Operating Temperature Range	T_J	- 55 to + 150							$^\circ\text{C}$
Storage Temperature Range	T_{STG}	- 55 to + 150							$^\circ\text{C}$

Note 1: Pulse Test with PW=300 usec, 1% Duty Cycle

Note 2: Reverse Recovery Test Conditions: $I_F=0.5A$, $I_R=1.0A$, $I_{RR}=0.25A$

Note 3: Measured at 1 MHz and Applied Reverse Voltage of 4.0V D.C.

RATINGS AND CHARACTERISTIC CURVES (FR151G THRU FR157G)

FIG. 1- MAXIMUM FORWARD CURRENT DERATING CURVE

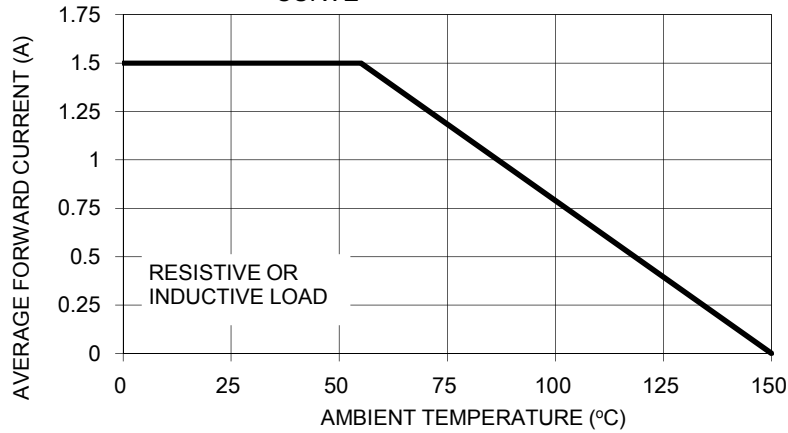

FIG. 2- TYPICAL REVERSE CHARACTERISTICS

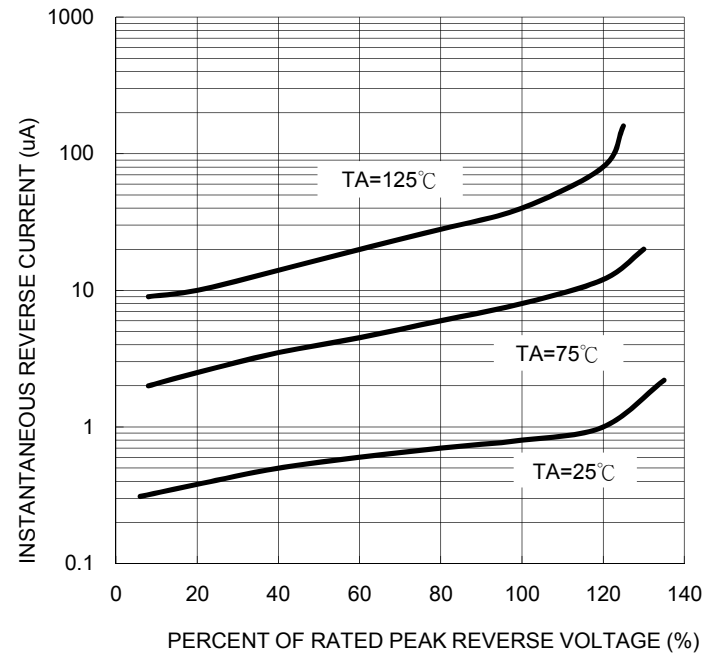

FIG. 3- MAXIMUM NON-REPETITIVE PEAK FORWARD SURGE CURRENT

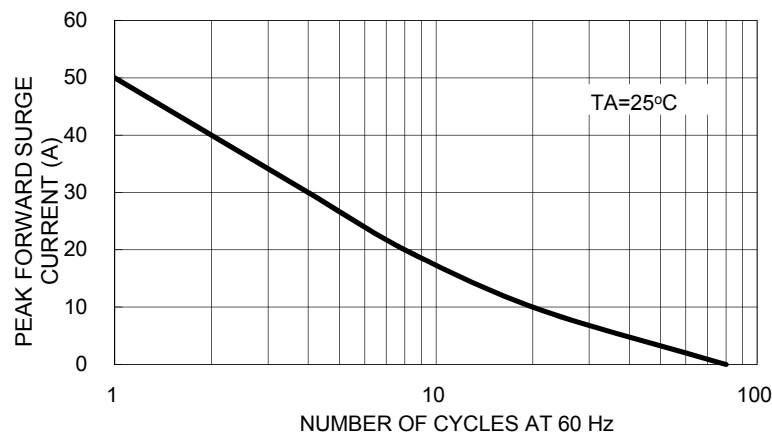

FIG. 5- TYPICAL FORWARD CHARACTERISTICS

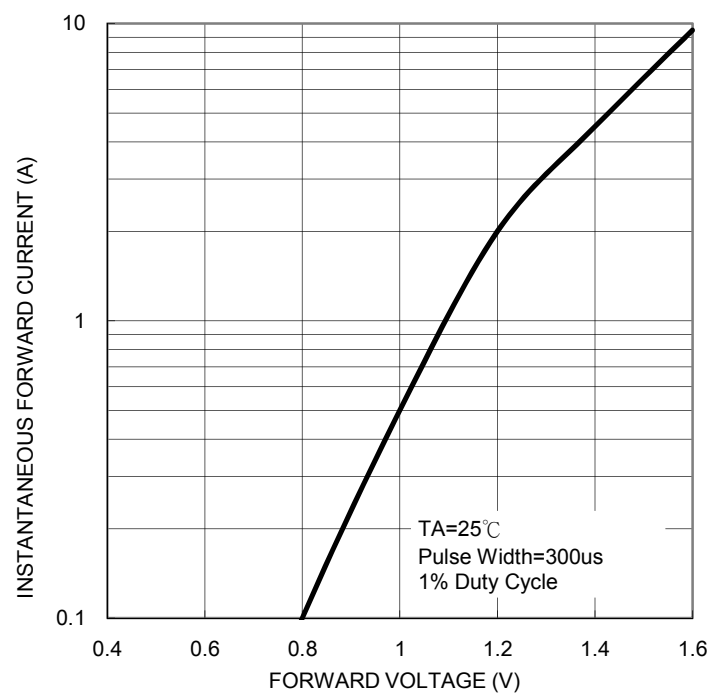

FIG. 4- TYPICAL JUNCTION CAPACITANCE

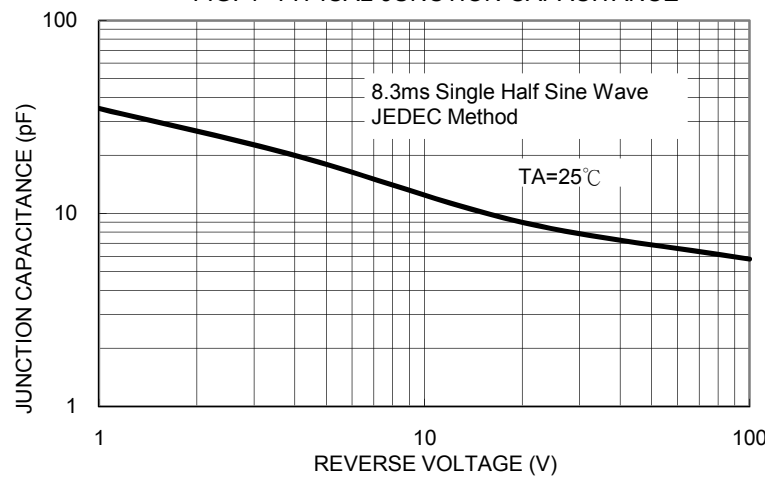
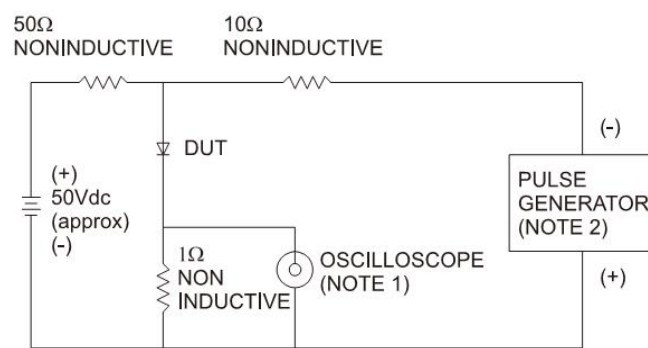
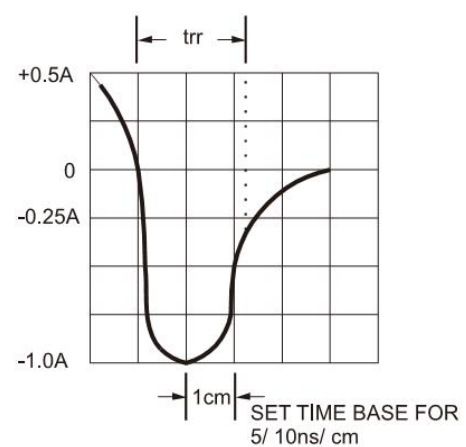

FIG. 6- REVERSE RECOVERY TIME CHARACTERISTIC AND TEST CIRCUIT DIAGRAM



- NOTES: 1. Rise Time=7ns max. Input Impedance=1 megohm 22pf
2. Rise Time=10ns max. Source Impedance=50 ohms



Ordering information

Part No.	Package	Packing	INNER TAPE	Packing code	Packing code (Green)
FR15xG (Note)	DO-15	1.5K / AMMO box	52mm	A0	A0G
	DO-15	3.5K / 13" Reel	52mm	R0	R0G
	DO-15	1K / Bulk packing		B0	B0G

Note: "x" is Device Code from "1" thru "7".

AXIAL LEAD TAPING SPECIFICATIONS

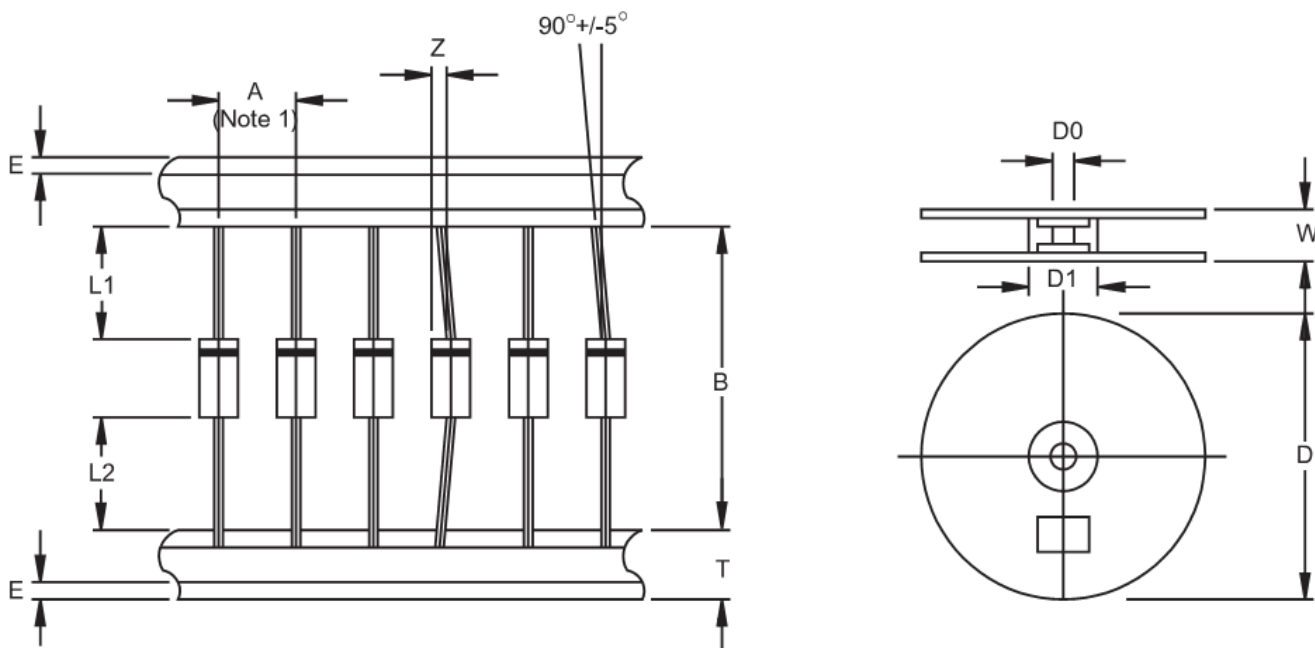

Outline	A	B	Z	T	E	L1-L2	D	D1	D0	W
		±0.5	±1.5	MAX	±0.4	MAX	MAX		±0.3	±0.4
DO-15	5	52.4	1.2	6	0.8	1	330	85.7	16.6	76

Unit (mm)

Suggested Mounting Hole Rule

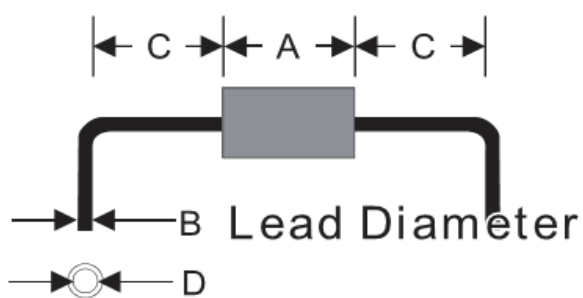

Symbol	Unit(mm)
A	6.4
B	0.8
C	3.0
D	1.2

Dimensions

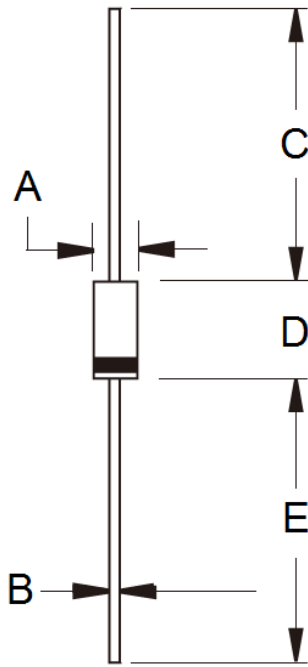

DIM.	Unit(mm)		Unit(inch)	
	Min	Max	Min	Max
A	2.60	3.60	0.102	0.142
B	0.70	0.90	0.028	0.035
C	25.40	-	1.000	-
D	5.80	7.60	0.228	0.299
E	25.40	-	1.000	-

Marking Diagram



- P/N = Specific Device Code
- G = Green Compound
- YWW = Date Code
- F = Factory Code